

111 Stamford Street

Created on
2021-09-02

Floors
2

▼ Ground Floor

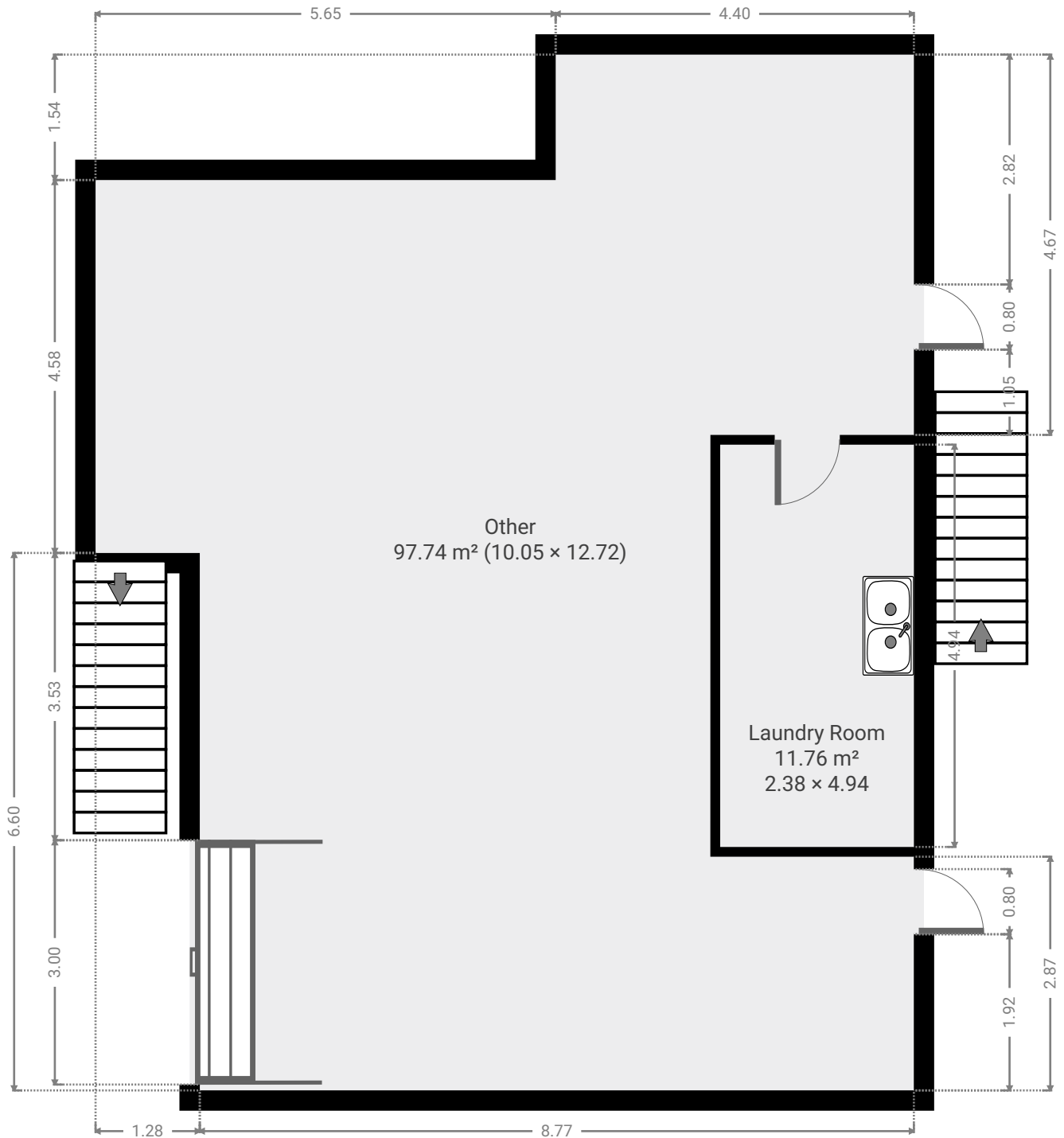

▼ Other
Ground Floor

WIDTH: 12.72 m • LENGTH: 10.05 m
AREA: 97.74 m² • PERIMETER: 50.54 m

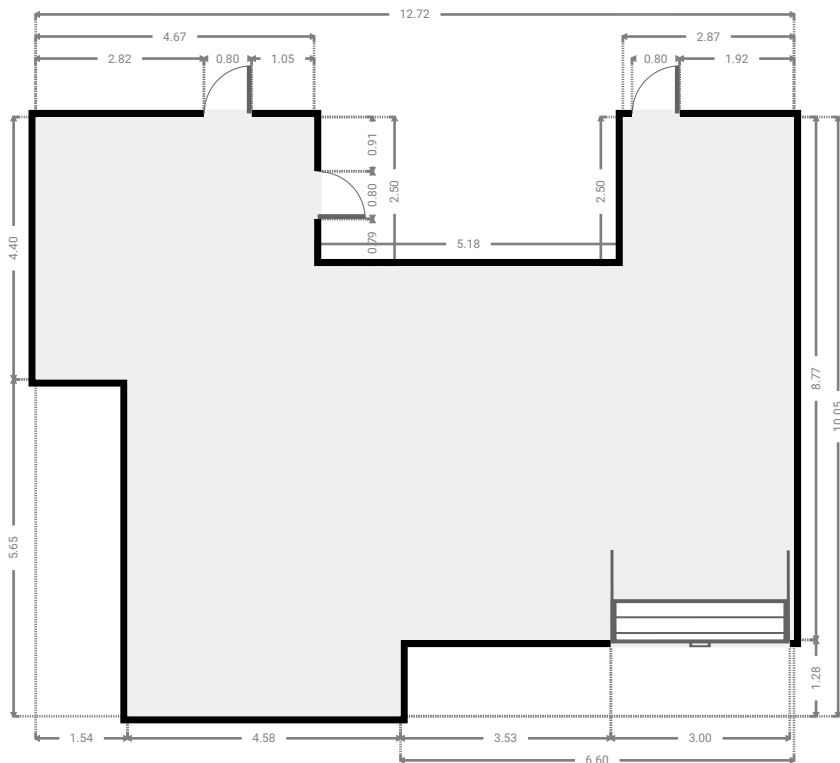
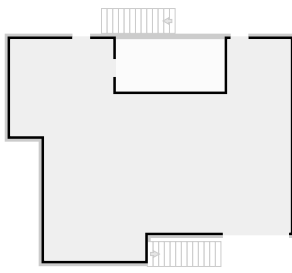

▼ Laundry Room
Ground Floor

WIDTH: 4.94 m • LENGTH: 2.38 m
AREA: 11.76 m² • PERIMETER: 14.64 m

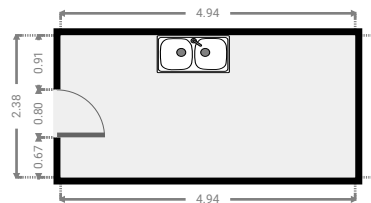
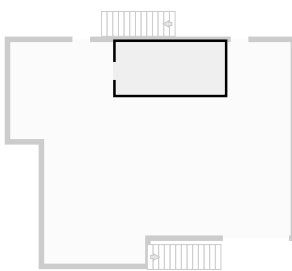

▼ 1st Floor

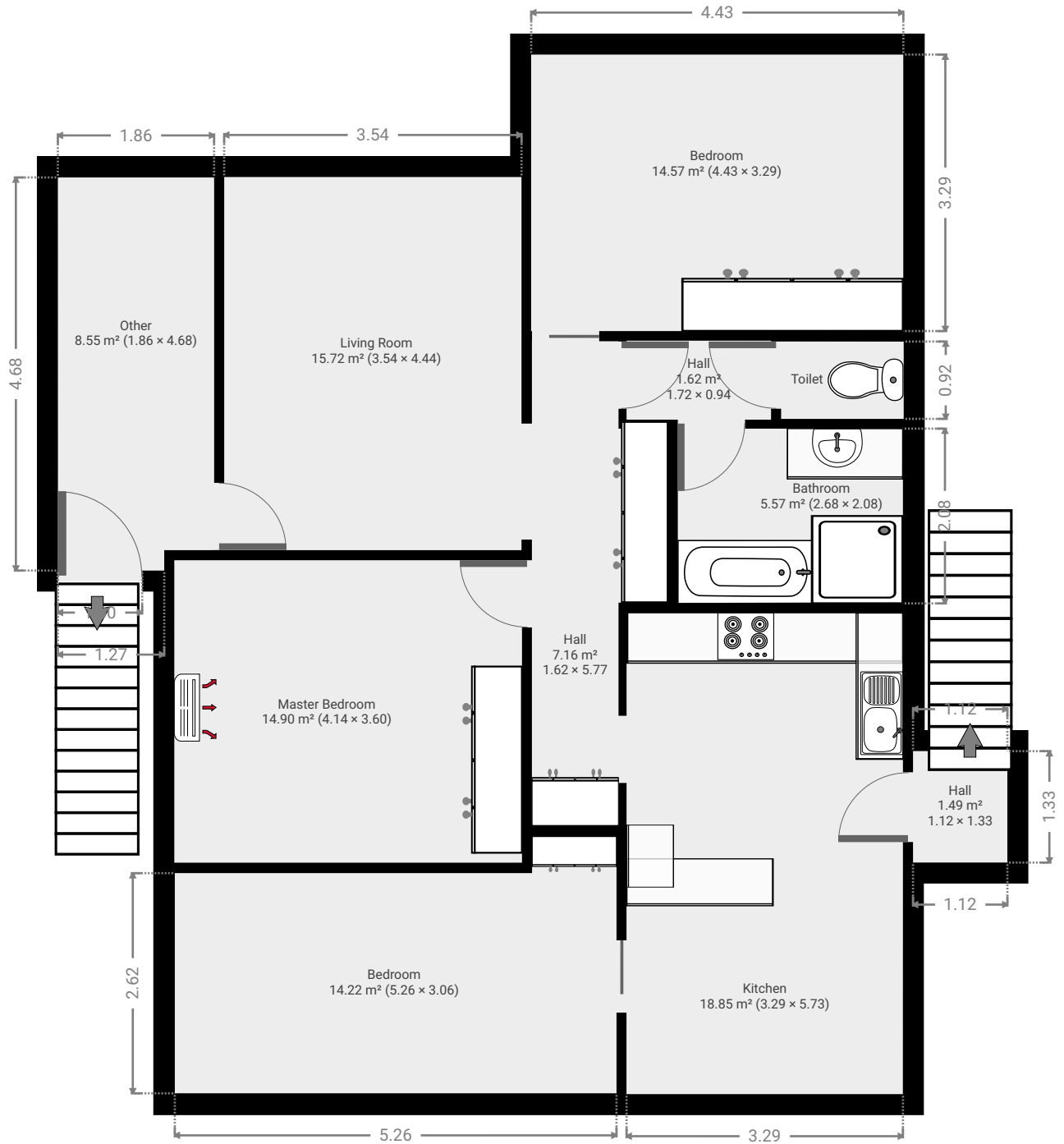

▼ Living Room
1st Floor

WIDTH: 4.44 m • LENGTH: 3.54 m
AREA: 15.72 m² • PERIMETER: 15.96 m

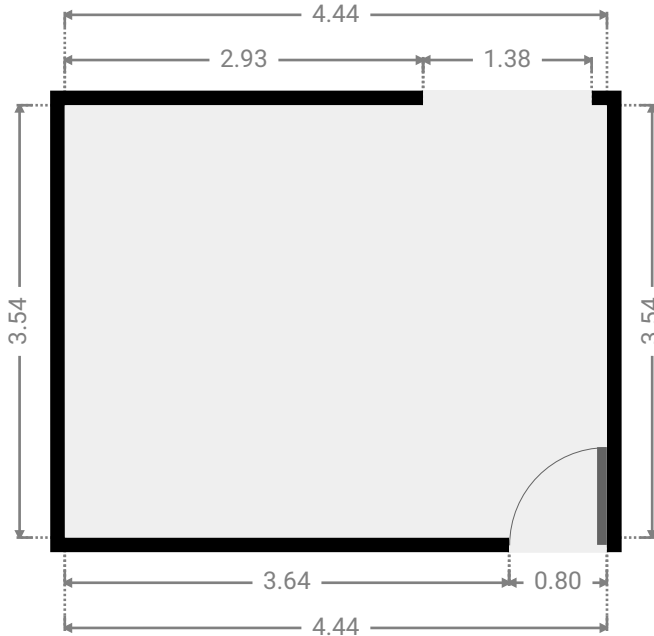
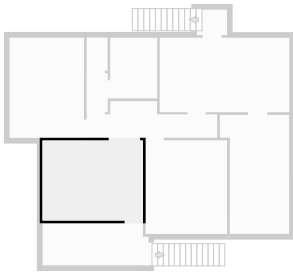

▼ Hall
1st Floor

WIDTH: 5.77 m • LENGTH: 1.62 m
AREA: 7.16 m² • PERIMETER: 14.77 m

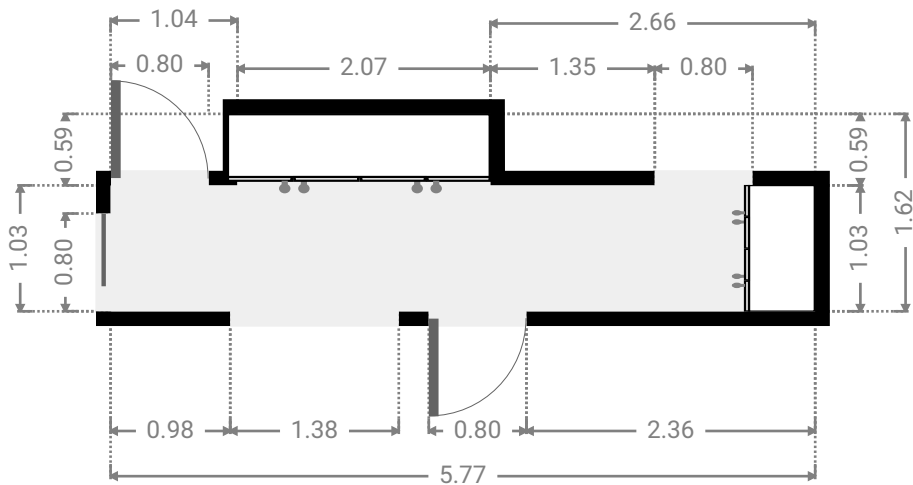
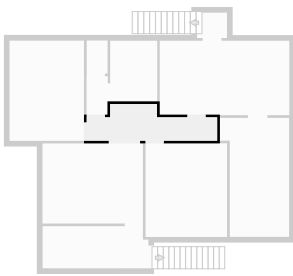

▼ **Master Bedroom**
1st Floor

WIDTH: 3.60 m • LENGTH: 4.14 m
AREA: 14.90 m² • PERIMETER: 15.48 m

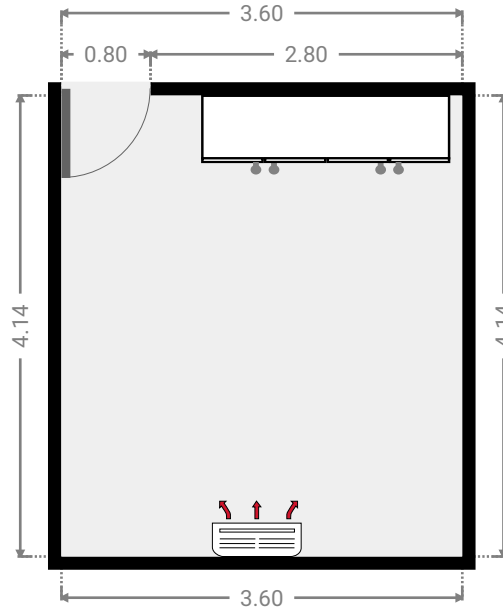
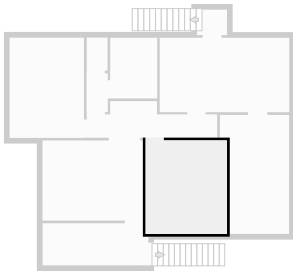

▼ **Bedroom**
1st Floor

WIDTH: 3.06 m • LENGTH: 5.26 m
AREA: 14.22 m² • PERIMETER: 16.63 m

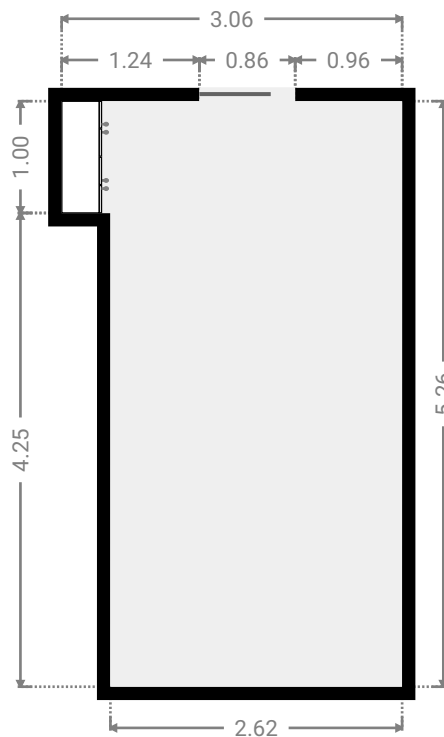
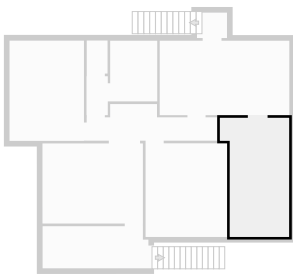

▼ **Kitchen**
1st Floor

WIDTH: 5.73 m • LENGTH: 3.29 m
AREA: 18.85 m² • PERIMETER: 18.04 m

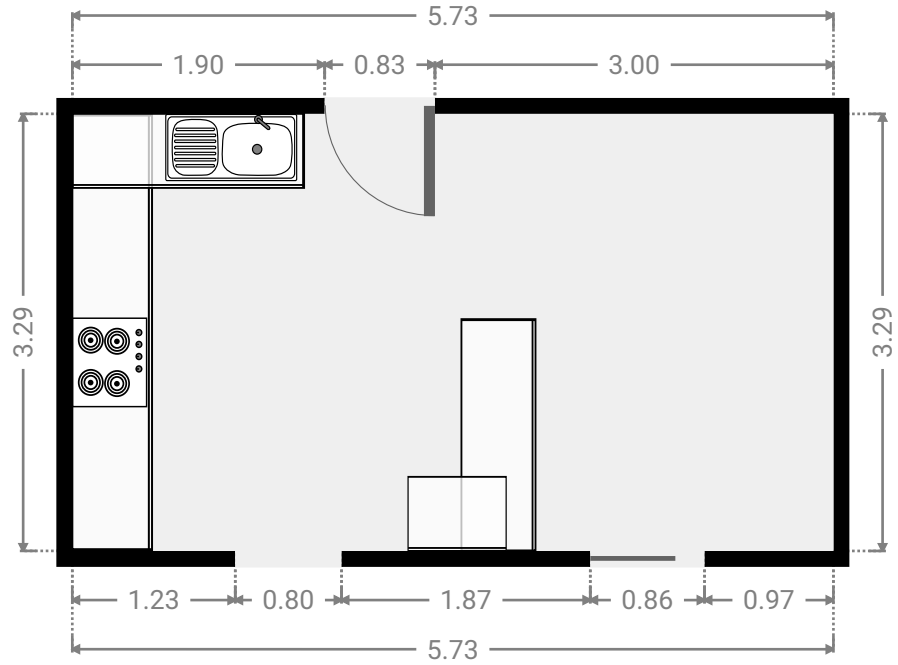
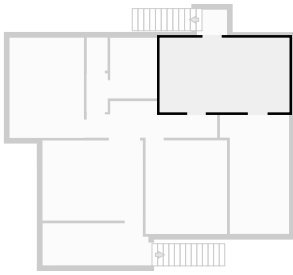

▼ **Bedroom**
1st Floor

WIDTH: 3.29 m • LENGTH: 4.43 m
AREA: 14.57 m² • PERIMETER: 15.44 m

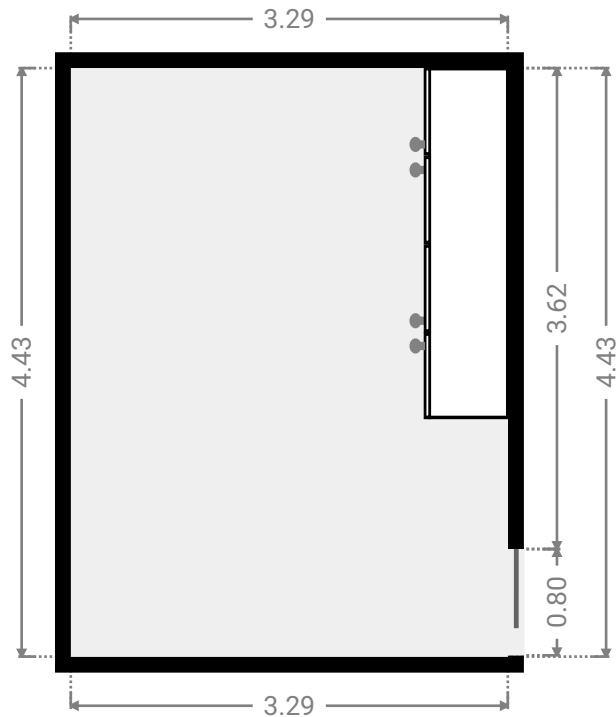
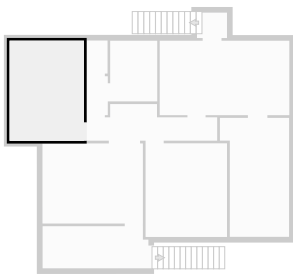

▼ Hall
1st Floor

WIDTH: 0.94 m • LENGTH: 1.72 m
AREA: 1.62 m² • PERIMETER: 5.32 m

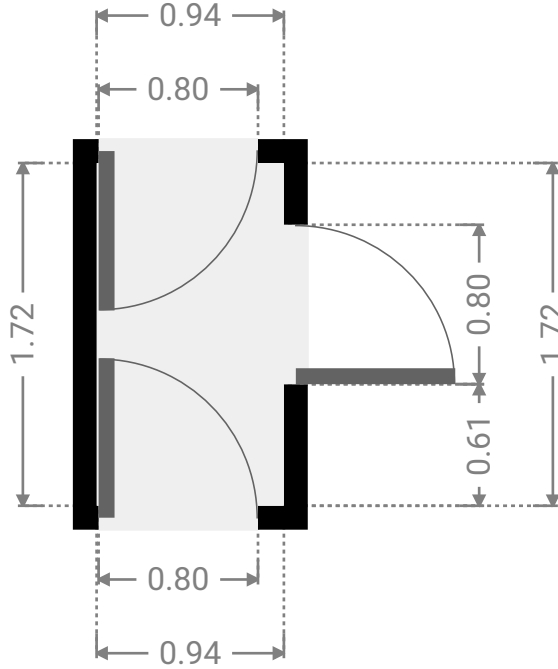
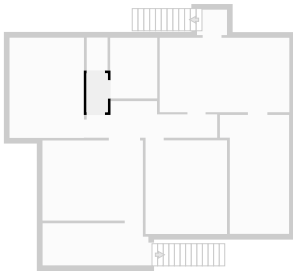

▼ Toilet
1st Floor

WIDTH: 0.92 m • LENGTH: 1.46 m
AREA: 1.34 m² • PERIMETER: 4.76 m

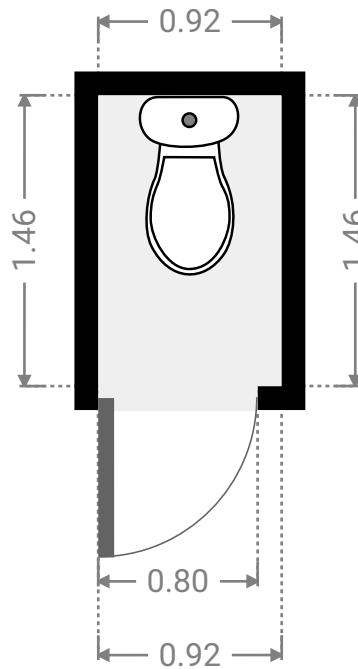

▼ **Bathroom**
1st Floor

WIDTH: 2.08 m • LENGTH: 2.68 m
AREA: 5.57 m² • PERIMETER: 9.52 m

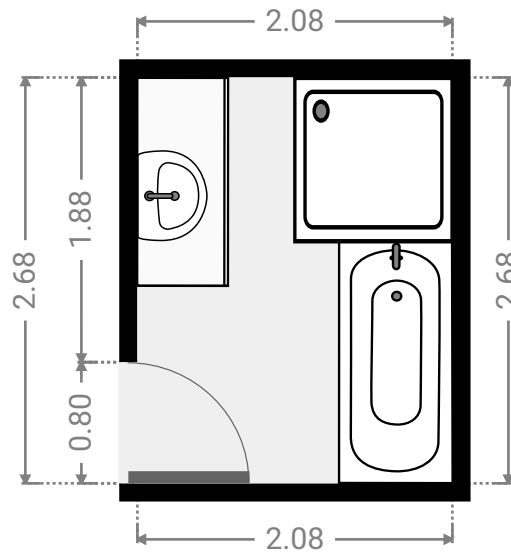
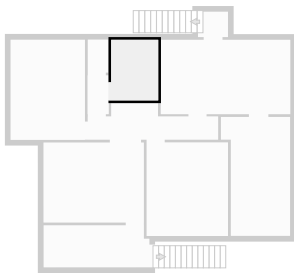

▼ **Other**
1st Floor

WIDTH: 4.68 m • LENGTH: 1.86 m
AREA: 8.55 m² • PERIMETER: 13.08 m

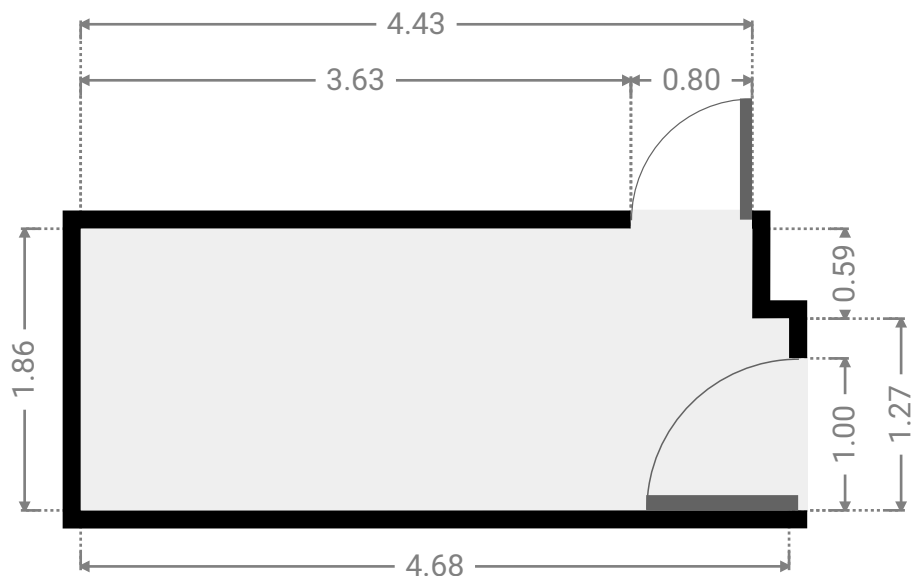

▼ Hall
1st Floor

WIDTH: 1.33 m • LENGTH: 1.12 m
AREA: 1.49 m² • PERIMETER: 4.90 m

