

111 McMillan Avenue

Created on
2020-11-19

Floors
2

▼ Ground Floor

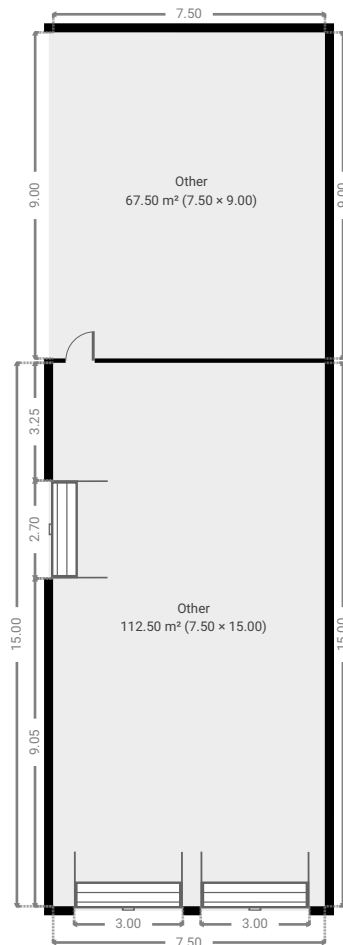
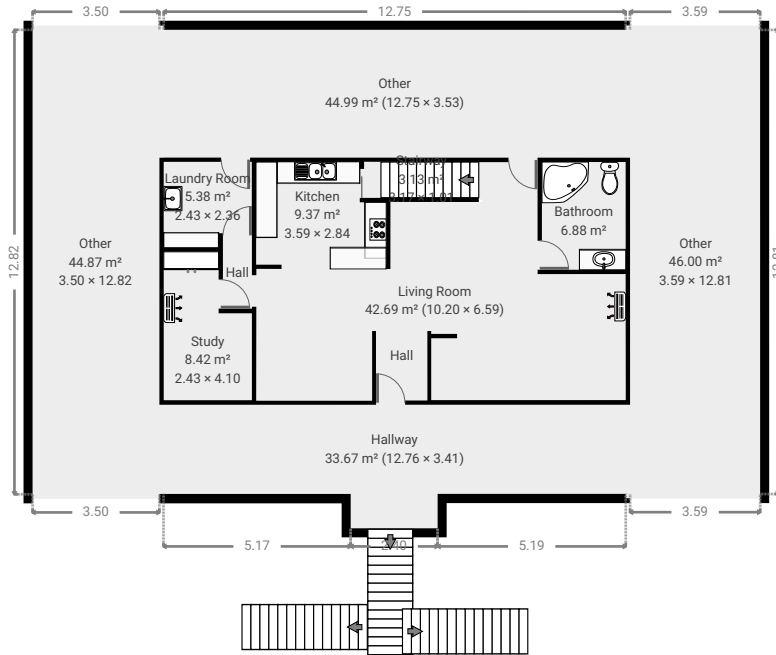

FLOORS:2

▼ **Hall**
Ground Floor

WIDTH:1.42 m · LENGTH:1.80 m
AREA:2.56 m² · PERIMETER:6.44 m

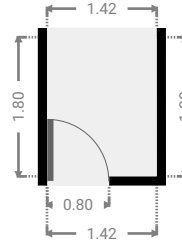
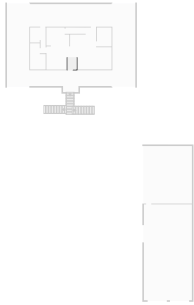

▼ **Living Room**
Ground Floor

WIDTH:10.20 m · LENGTH:6.59 m
AREA:42.69 m² · PERIMETER:37.39 m

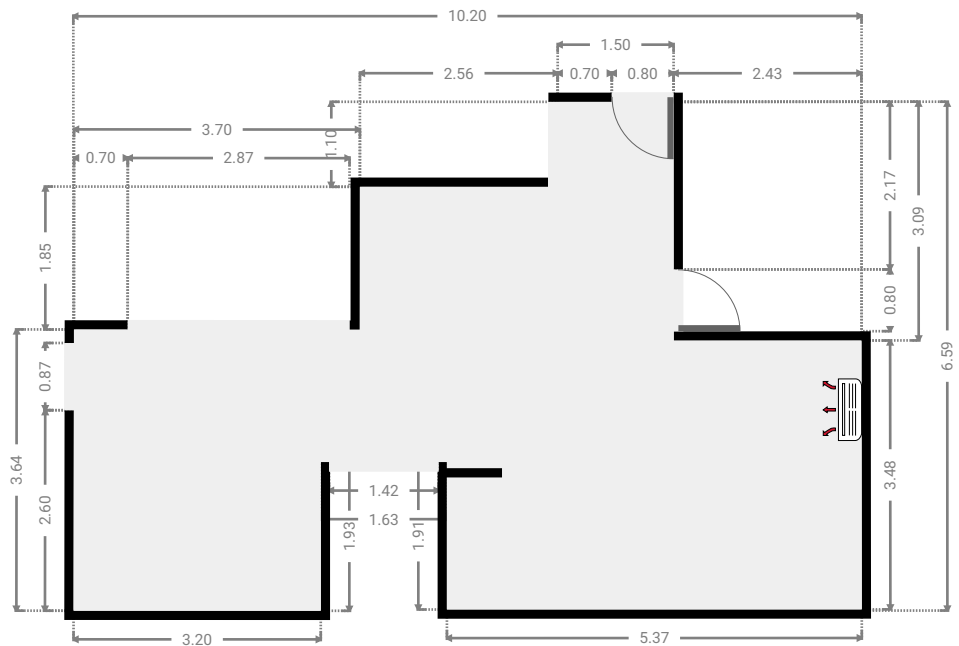
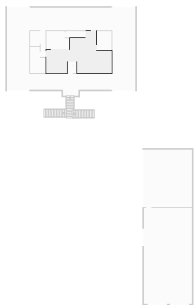

▼ **Bathroom**
Ground Floor

WIDTH:2.31 m · LENGTH:2.97 m
AREA:6.88 m² · PERIMETER:10.57 m

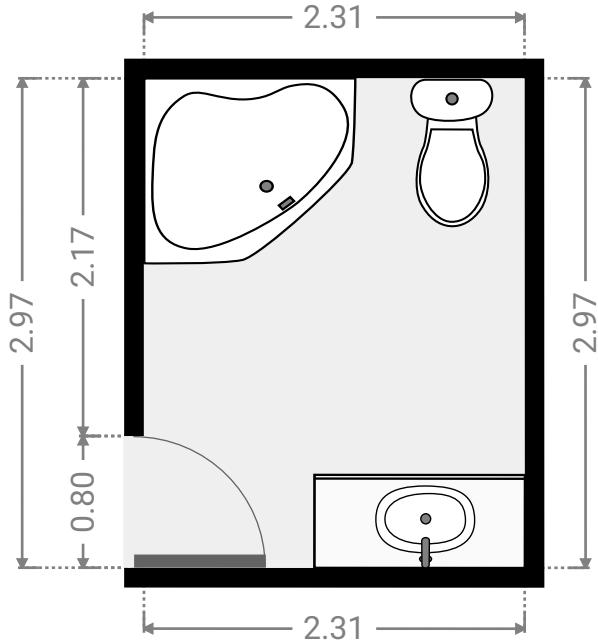
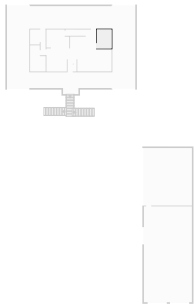

▼ **Kitchen**
Ground Floor

WIDTH:3.59 m · LENGTH:2.84 m
AREA:9.37 m² · PERIMETER:12.85 m

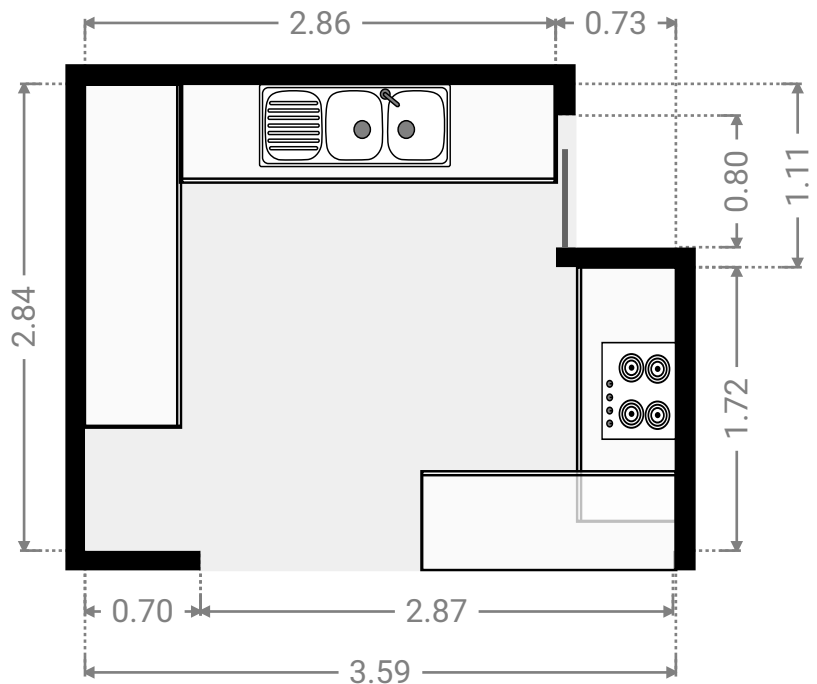
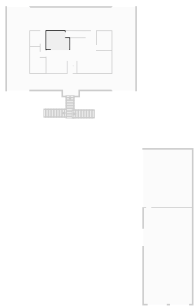

▼ **Stairway**
Ground Floor

WIDTH:3.17 m · LENGTH:1.01 m
AREA:3.13 m² · PERIMETER:8.31 m

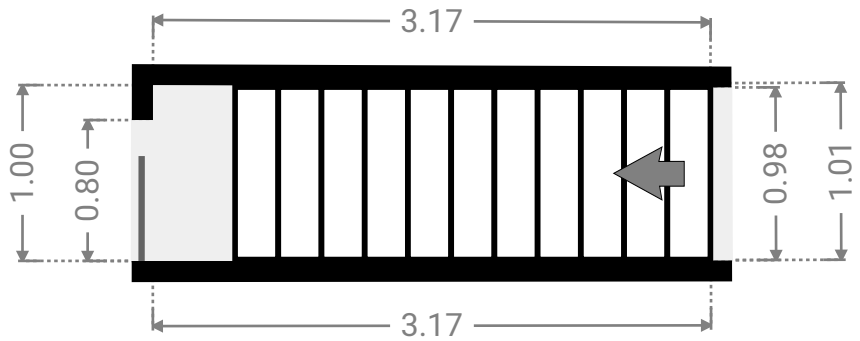
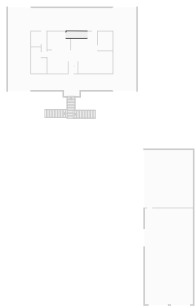

▼ **Hall**
Ground Floor

WIDTH:0.80 m · LENGTH:1.96 m
AREA:1.57 m² · PERIMETER:5.52 m

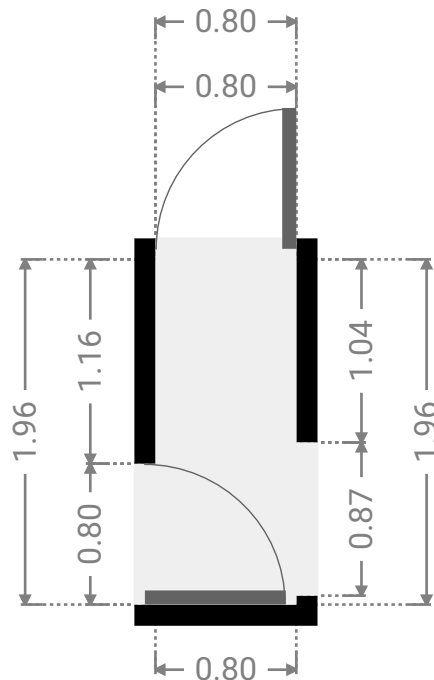
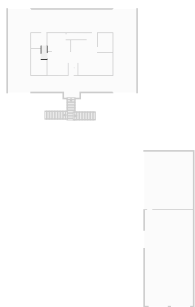

▼ **Study**
Ground Floor

WIDTH:2.43 m · LENGTH:4.10 m
AREA:8.42 m² · PERIMETER:13.07 m

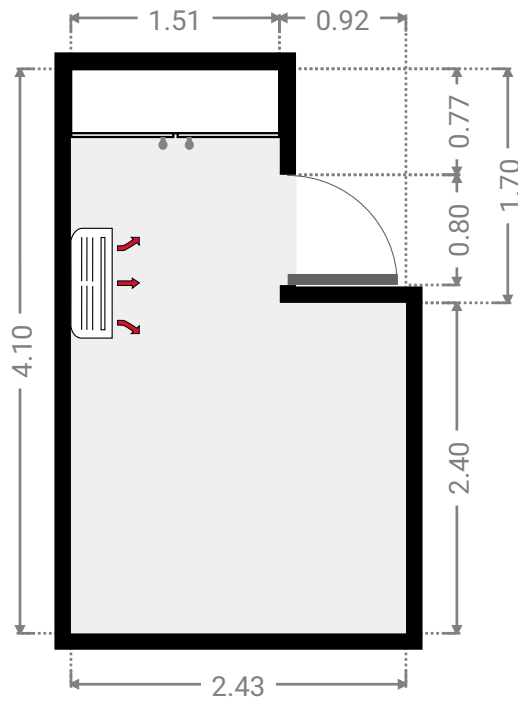
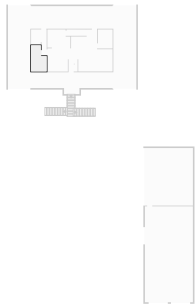

▼ **Laundry Room**
Ground Floor

WIDTH:2.43 m · LENGTH:2.36 m
AREA:5.38 m² · PERIMETER:9.58 m

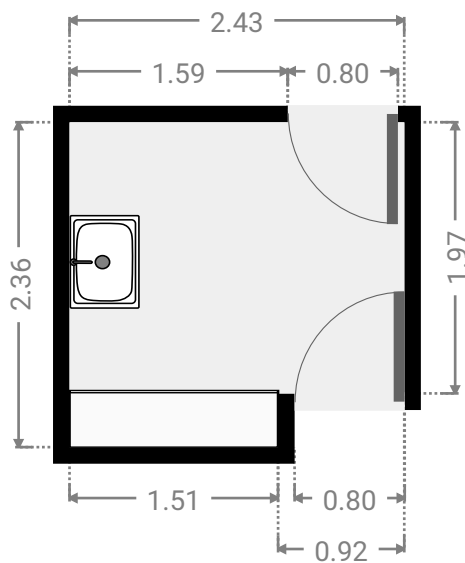
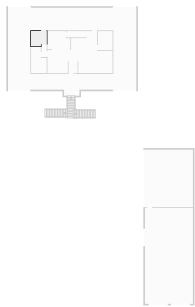

▼ **Hallway**
Ground Floor

WIDTH:12.76 m · LENGTH:3.41 m
AREA:33.67 m² · PERIMETER:32.34 m

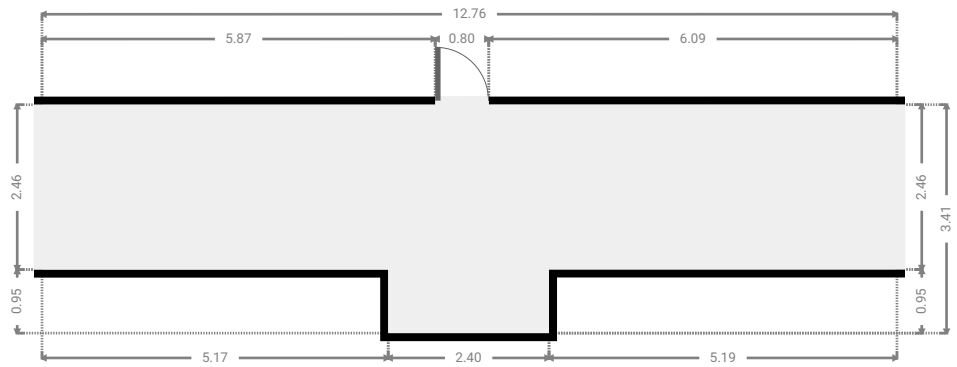
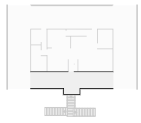

▼ **Other**
Ground Floor

WIDTH:12.75 m · LENGTH:3.53 m
AREA:44.99 m² · PERIMETER:32.56 m

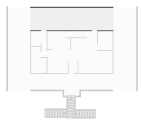

▼ Other
Ground Floor

WIDTH:3.59 m · LENGTH:12.81 m
AREA:46.00 m² · PERIMETER:32.80 m

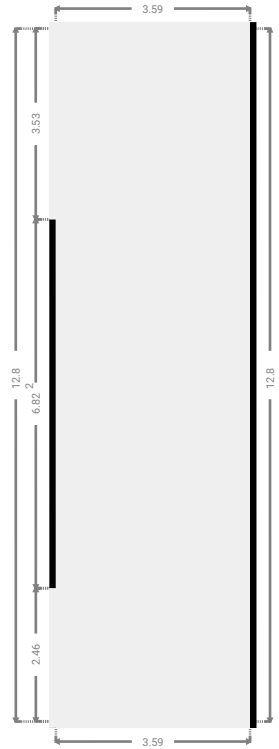
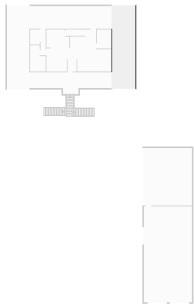

▼ Other
Ground Floor

WIDTH:3.50 m · LENGTH:12.82 m
AREA:44.87 m² · PERIMETER:32.64 m

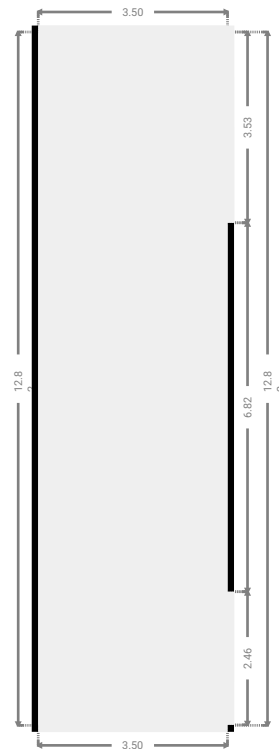
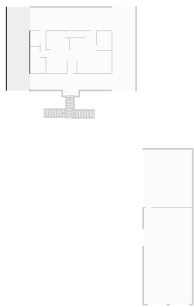

▼ Other
Ground Floor

WIDTH:7.50 m · LENGTH:9.00 m
AREA:67.50 m² · PERIMETER:33.00 m

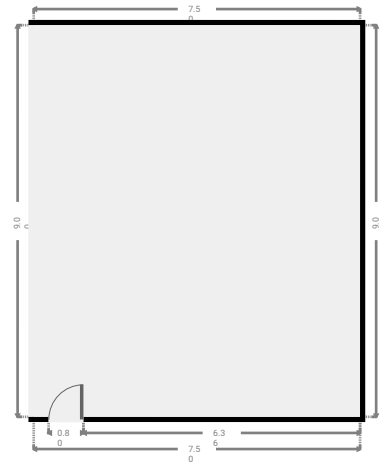
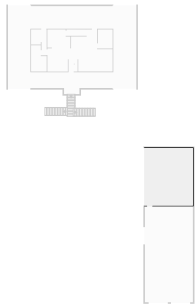

▼ Other
Ground Floor

WIDTH:7.50 m · LENGTH:15.00 m
AREA:112.50 m² · PERIMETER:45.00 m

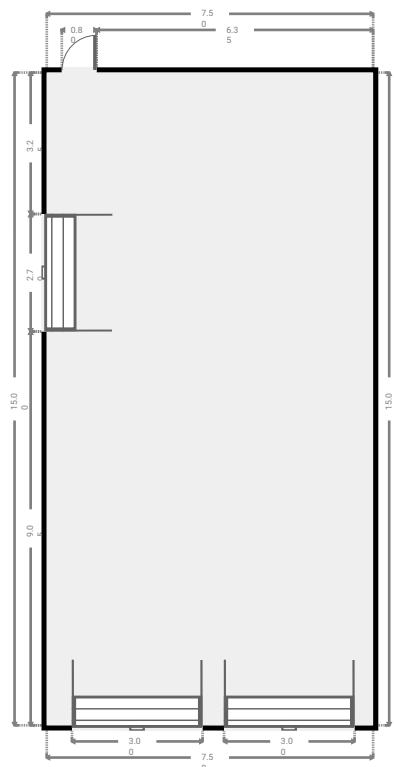
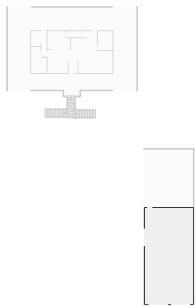

▼ 1st Floor

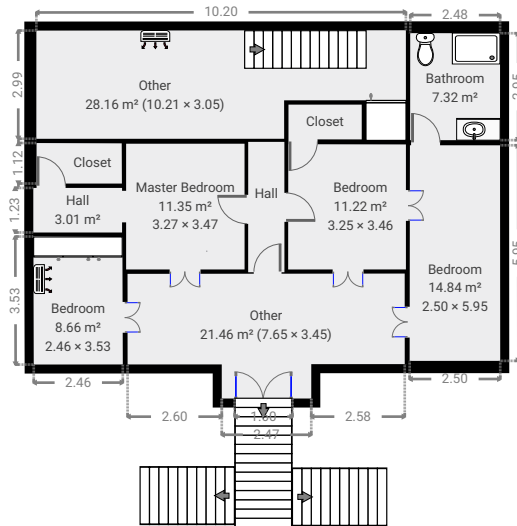

▼ Other
1st Floor

WIDTH:7.65 m · LENGTH:3.45 m
AREA:21.46 m² · PERIMETER:22.19 m

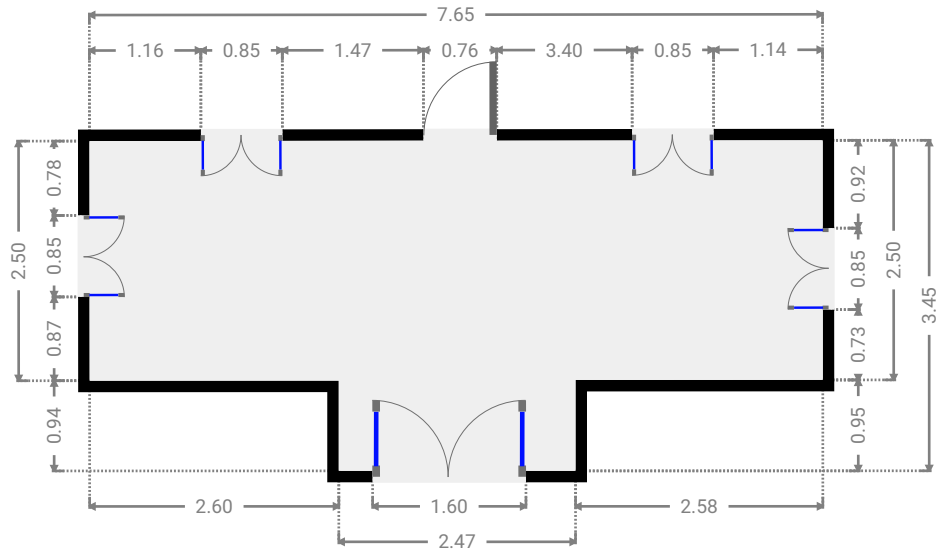
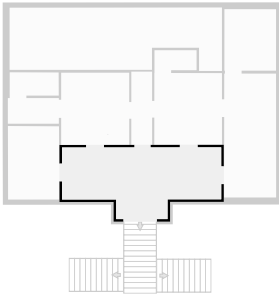

▼ Hall
1st Floor

WIDTH:1.00 m · LENGTH:3.60 m
AREA:3.59 m² · PERIMETER:9.20 m

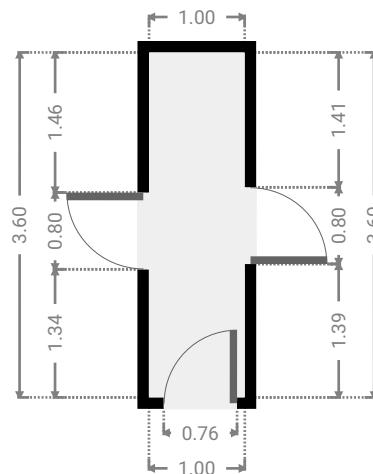
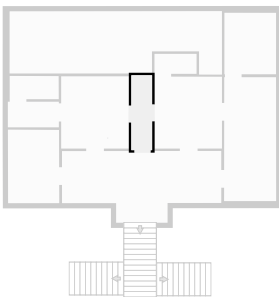

▼ **Bedroom**
1st Floor

WIDTH:3.25 m · LENGTH:3.46 m
AREA:11.22 m² · PERIMETER:13.41 m

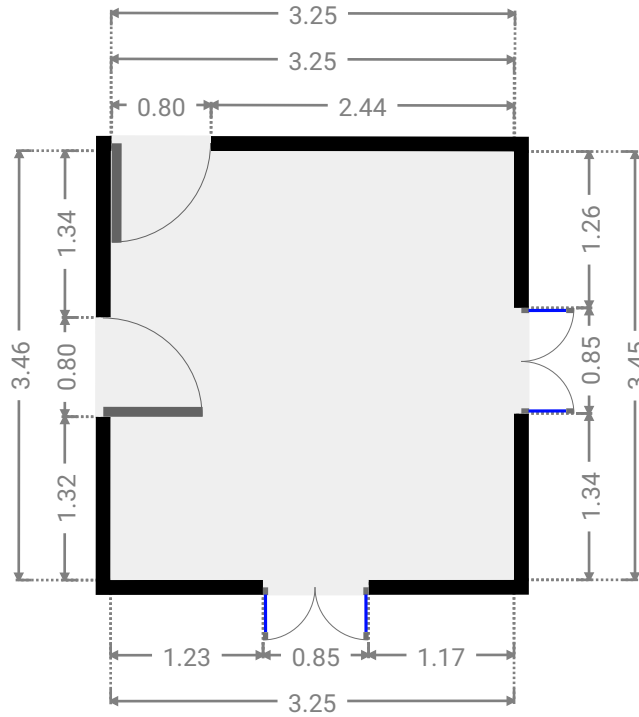
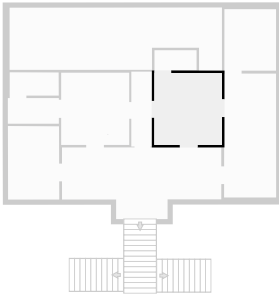

▼ **Closet**
1st Floor

WIDTH:2.03 m · LENGTH:0.96 m
AREA:1.94 m² · PERIMETER:5.96 m

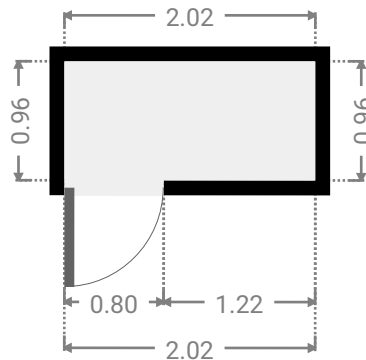
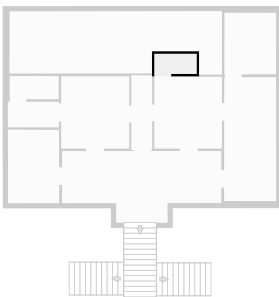

▼ **Master Bedroom**
1st Floor

WIDTH:3.27 m · LENGTH:3.47 m
AREA:11.35 m² · PERIMETER:13.48 m

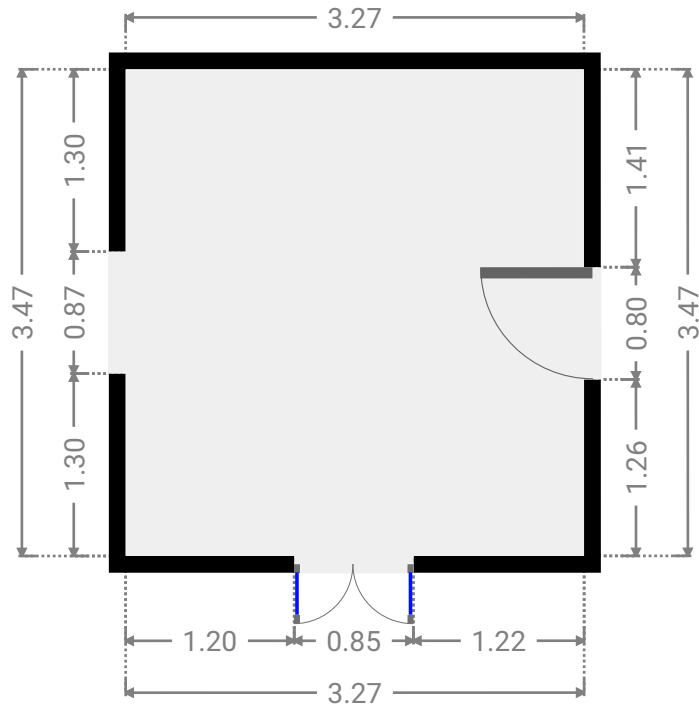
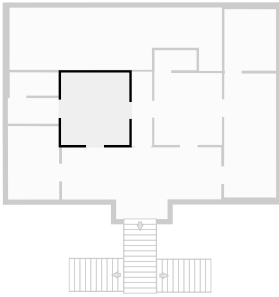

▼ **Hall**
1st Floor

WIDTH:2.45 m · LENGTH:1.23 m
AREA:3.01 m² · PERIMETER:7.36 m

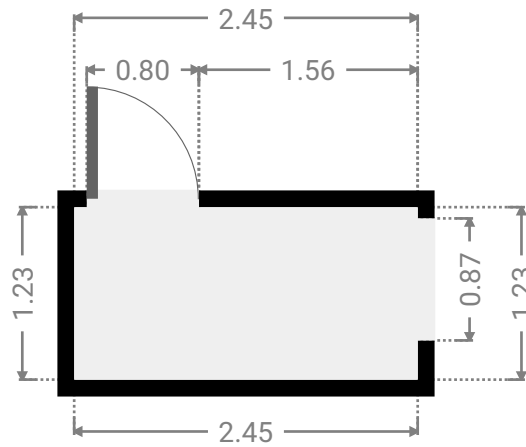
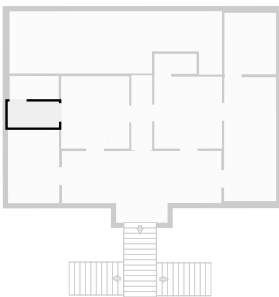

▼ **Closet**
1st Floor

WIDTH:2.35 m · LENGTH:1.13 m
AREA:2.62 m² · PERIMETER:6.93 m

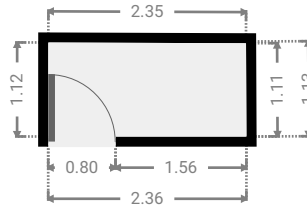
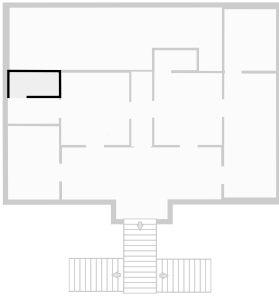

▼ **Other**
1st Floor

WIDTH:10.21 m · LENGTH:3.05 m
AREA:28.16 m² · PERIMETER:28.61 m

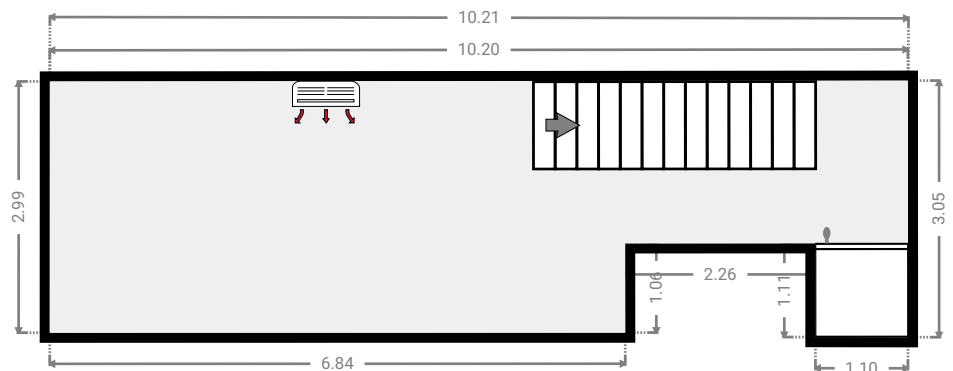
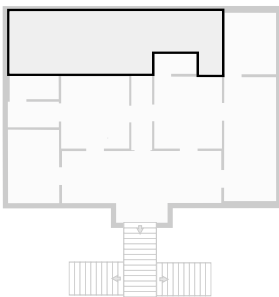

▼ **Bathroom**
1st Floor

WIDTH:2.48 m · LENGTH:2.95 m
AREA:7.32 m² · PERIMETER:10.87 m

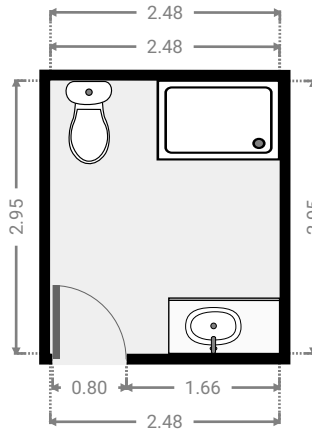
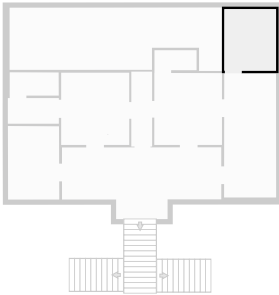

▼ **Bedroom**
1st Floor

WIDTH:2.50 m · LENGTH:5.95 m
AREA:14.84 m² · PERIMETER:16.89 m

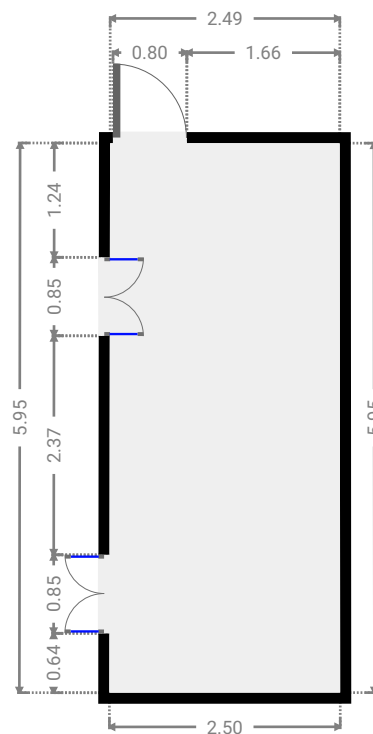
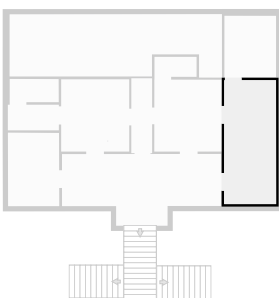

▼ **Bedroom**
1st Floor

WIDTH:2.47 m · LENGTH:3.54 m
AREA:8.66 m² · PERIMETER:11.96 m

