

11 Ferguson Street

Ground Floor

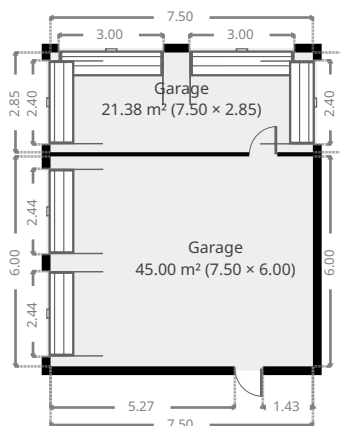

THIS FLOORPLAN IS PROVIDED WITHOUT WARRANTY OF ANY KIND. SENSOPIA DISCLAIMS ANY WARRANTY INCLUDING, WITHOUT LIMITATION, SATISFACTORY QUALITY OR ACCURACY OF DIMENSIONS.

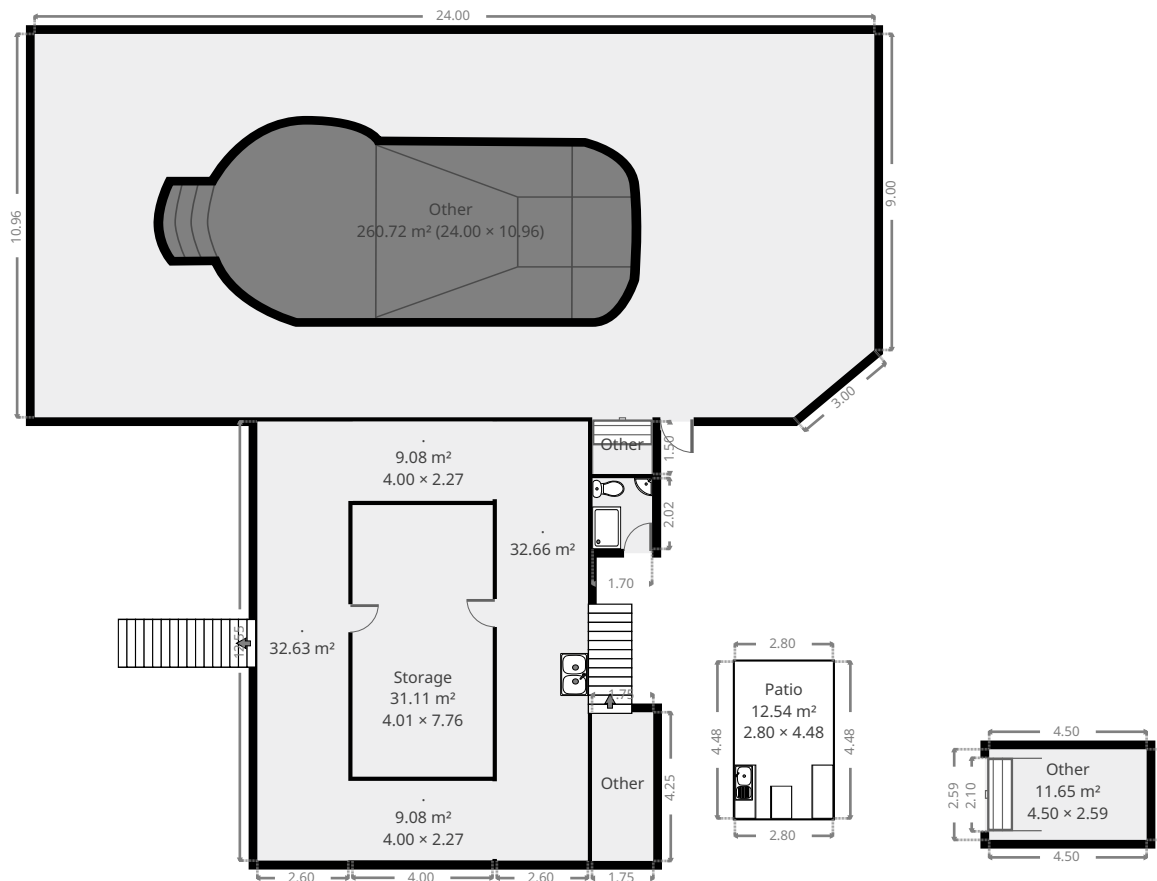
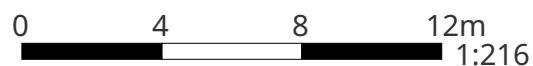

11 Ferguson Street

•
Width: 2.60 m
Length: 12.55 m
Area: 32.66 m²
Perimeter: 30.30 m

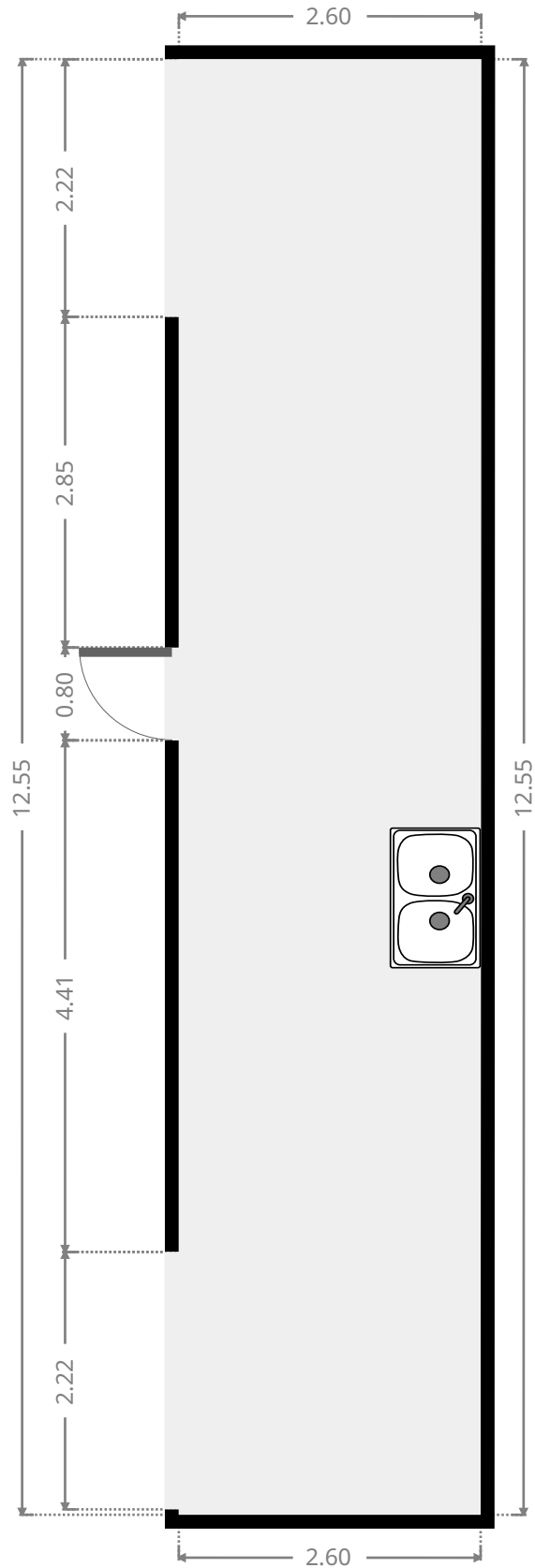
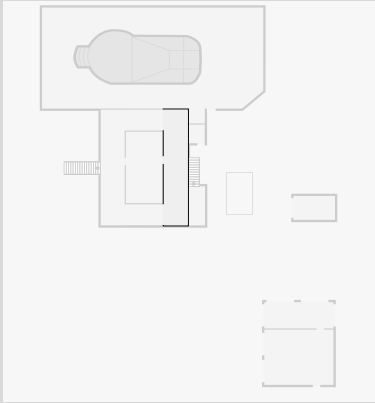

THIS FLOORPLAN IS PROVIDED WITHOUT WARRANTY OF ANY KIND. SENSOPIA DISCLAIMS ANY WARRANTY INCLUDING, WITHOUT LIMITATION, SATISFACTORY QUALITY OR ACCURACY OF DIMENSIONS.

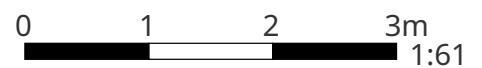

11 Ferguson Street

•
Width: 2.27 m
Length: 4.00 m
Area 9.08 m²
Perimeter 12.54 m

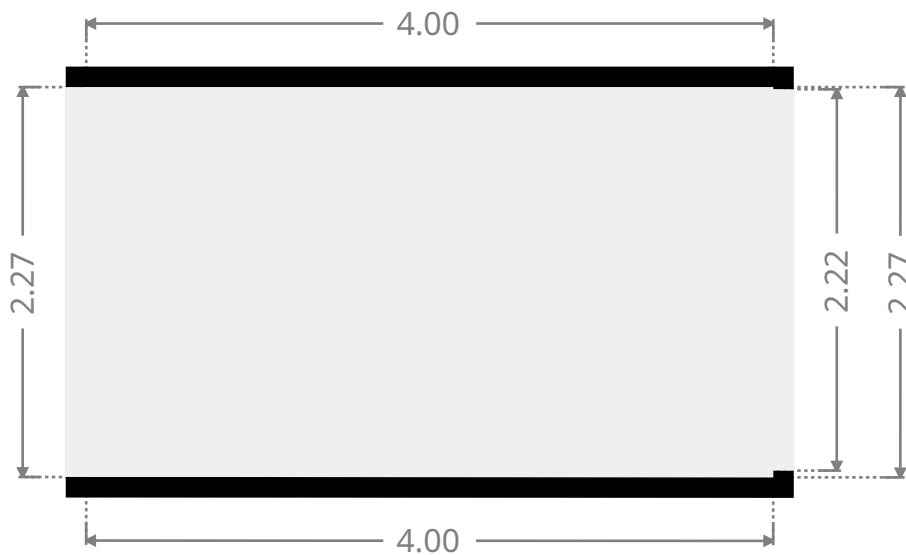
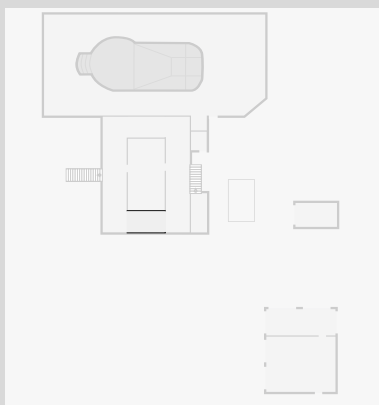

•
Width: 2.27 m
Length: 4.00 m
Area 9.08 m²
Perimeter 12.54 m

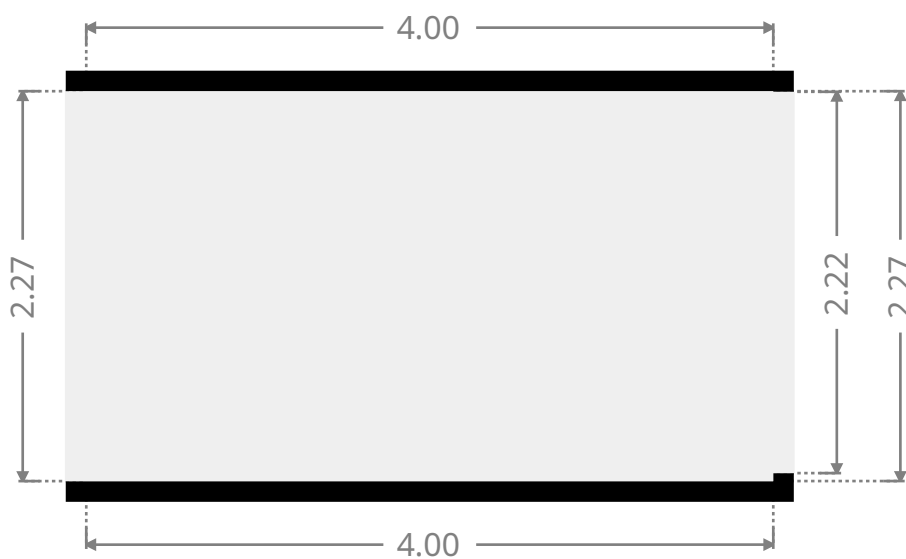
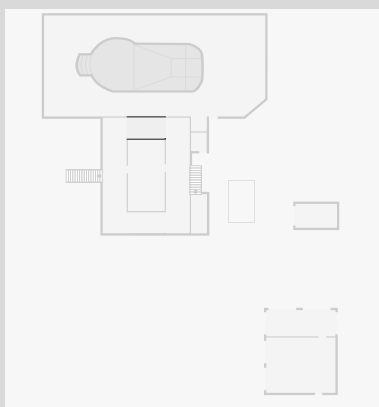

THIS FLOORPLAN IS PROVIDED WITHOUT WARRANTY OF ANY KIND. SENSOPIA DISCLAIMS ANY WARRANTY INCLUDING, WITHOUT LIMITATION, SATISFACTORY QUALITY OR ACCURACY OF DIMENSIONS.

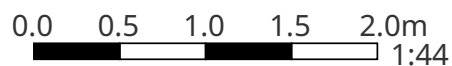

11 Ferguson Street

•
Width: 2.60 m
Length: 12.55 m
Area: 32.63 m²
Perimeter: 30.30 m

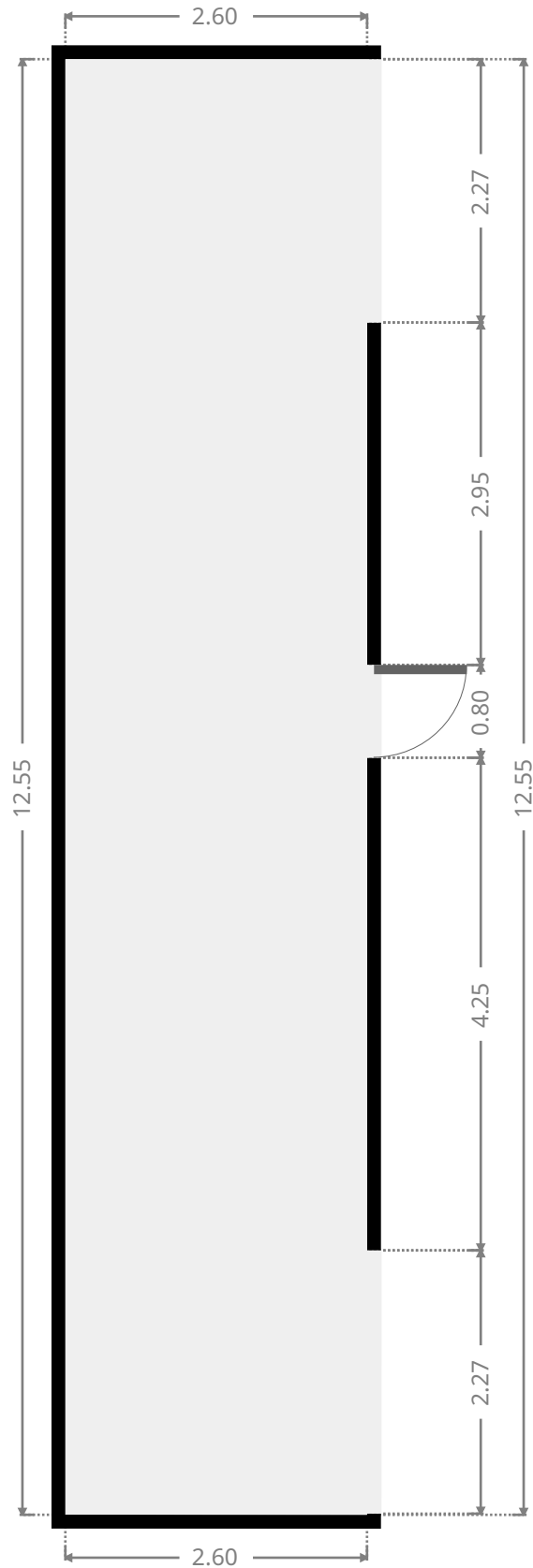
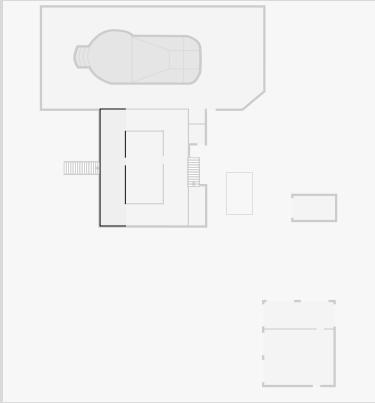

THIS FLOORPLAN IS PROVIDED WITHOUT WARRANTY OF ANY KIND. SENSOPIA DISCLAIMS ANY WARRANTY INCLUDING, WITHOUT LIMITATION, SATISFACTORY QUALITY OR ACCURACY OF DIMENSIONS.

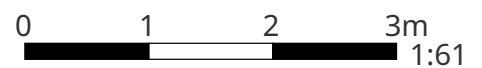

11 Ferguson Street

Storage

Width: 4.01 m
 Length: 7.76 m
 Area: 31.11 m²
 Perimeter: 23.54 m

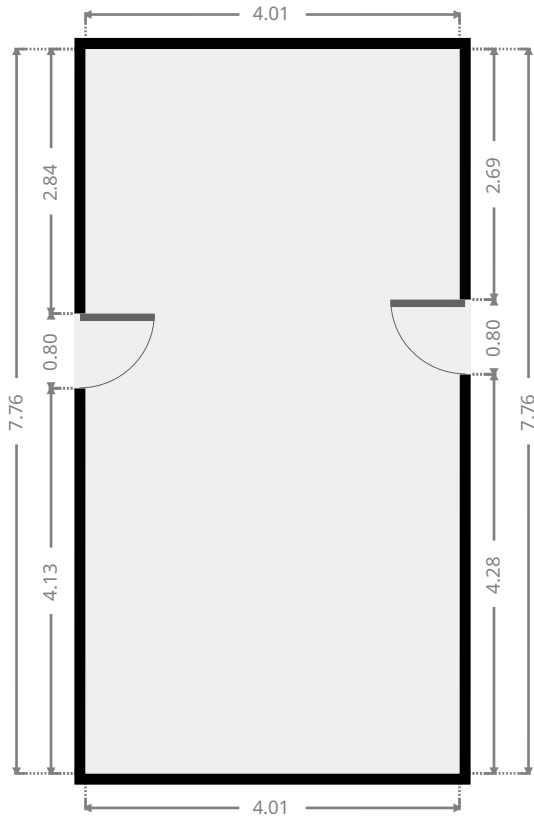
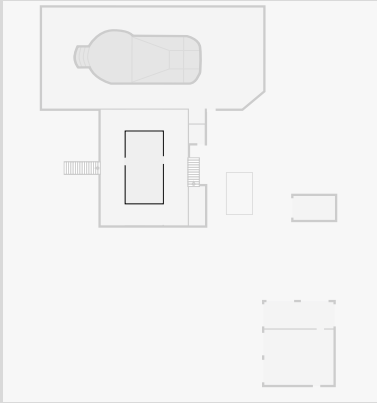

Other

Width: 1.75 m
 Length: 4.25 m
 Area: 7.44 m²
 Perimeter: 12.00 m

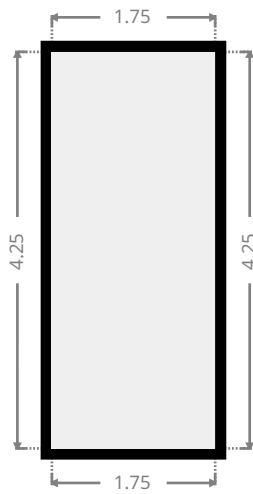
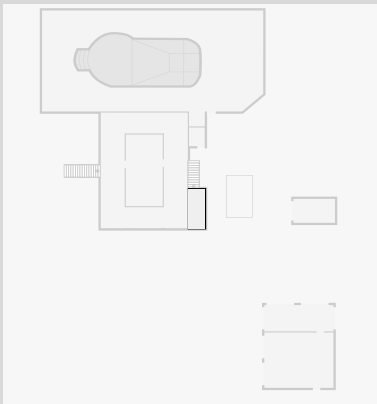

11 Ferguson Street

Bathroom

Width: 1.70 m
Length: 2.02 m
Area: 3.43 m²
Perimeter: 7.44 m

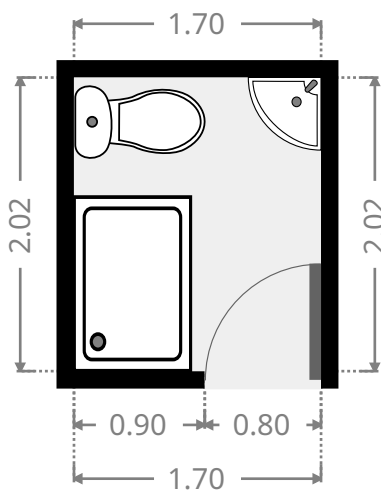
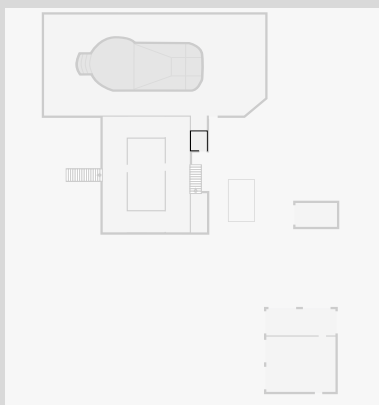

Patio

Width: 2.80 m
Length: 4.48 m
Area: 12.54 m²
Perimeter: 14.56 m

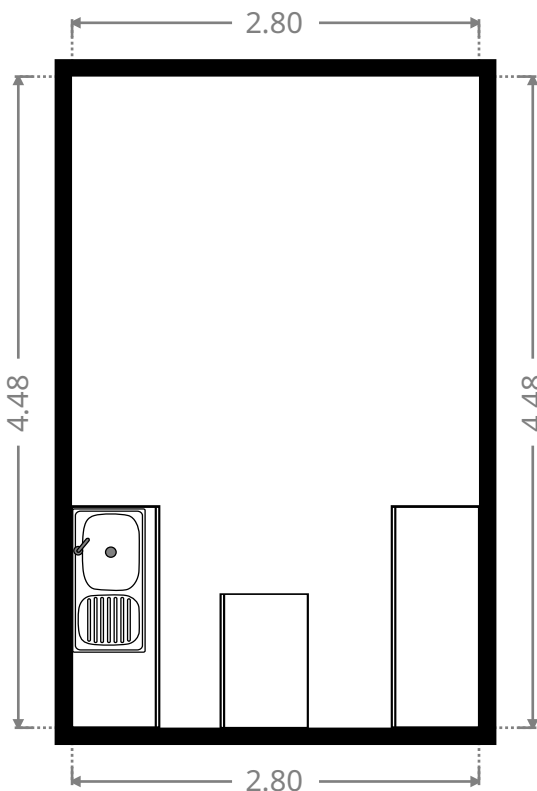
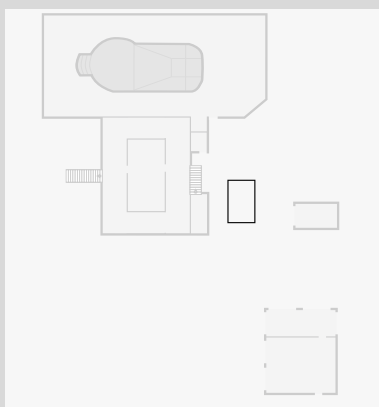

THIS FLOORPLAN IS PROVIDED WITHOUT WARRANTY OF ANY KIND. SENSOPIA DISCLAIMS ANY WARRANTY INCLUDING, WITHOUT LIMITATION, SATISFACTORY QUALITY OR ACCURACY OF DIMENSIONS.

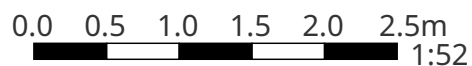

11 Ferguson Street

Garage

Width: 6.00 m
 Length: 7.50 m
 Area: 45.00 m²
 Perimeter: 27.00 m

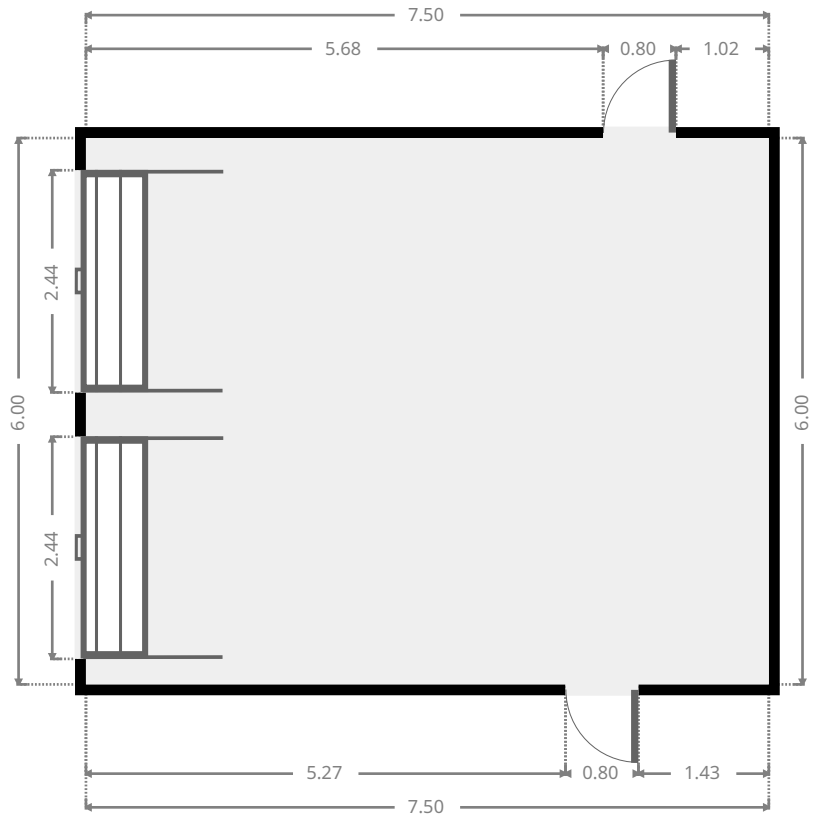
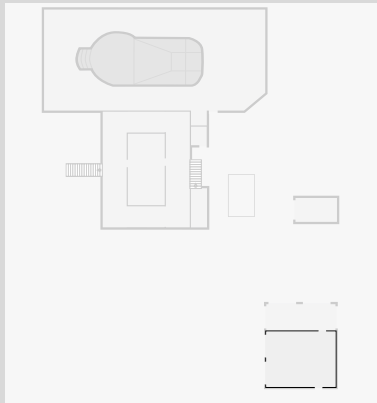

Garage

Width: 2.85 m
 Length: 7.50 m
 Area: 21.38 m²
 Perimeter: 20.70 m

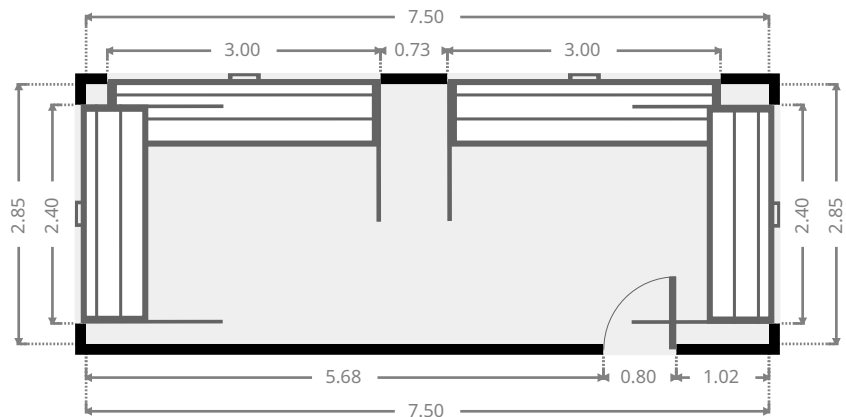
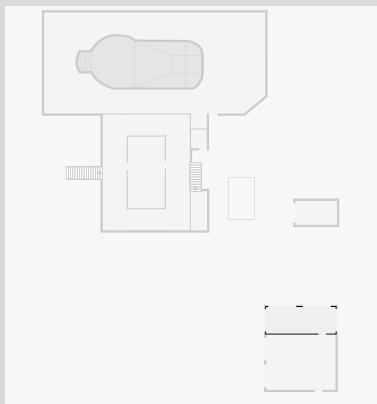

THIS FLOORPLAN IS PROVIDED WITHOUT WARRANTY OF ANY KIND. SENSOPIA DISCLAIMS ANY WARRANTY INCLUDING, WITHOUT LIMITATION, SATISFACTORY QUALITY OR ACCURACY OF DIMENSIONS.



11 Ferguson Street

Other

Width: 2.59 m
Length: 4.50 m
Area: 11.65 m²
Perimeter: 14.18 m

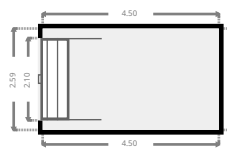
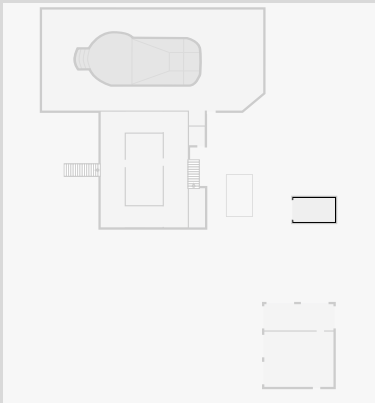

Other

Width: 10.96 m
Length: 24.00 m
Area: 260.72 m²
Perimeter: 68.69 m

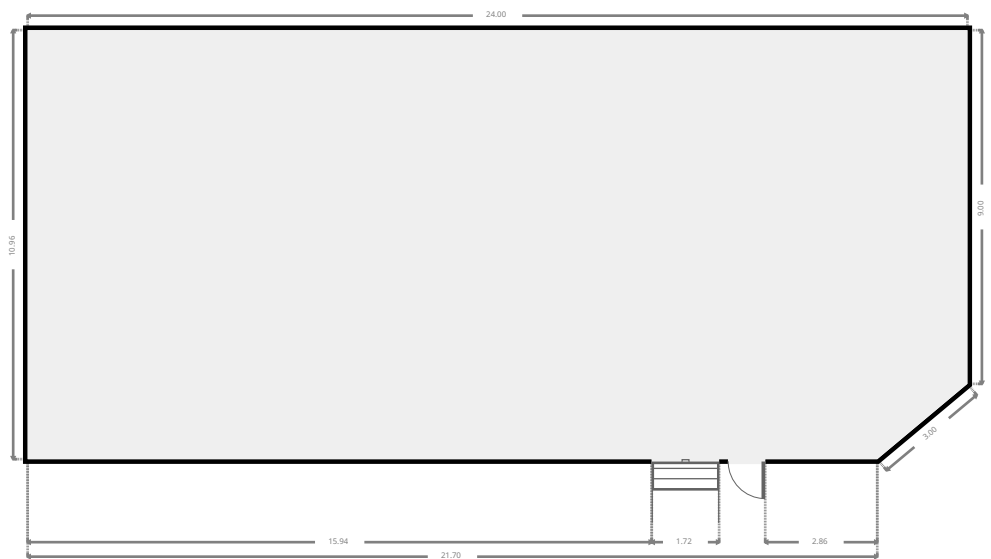
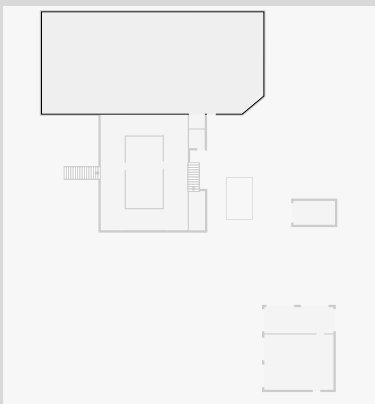

THIS FLOORPLAN IS PROVIDED WITHOUT WARRANTY OF ANY KIND. SENSOPIA DISCLAIMS ANY WARRANTY INCLUDING, WITHOUT LIMITATION, SATISFACTORY QUALITY OR ACCURACY OF DIMENSIONS.



11 Ferguson Street

Other

Width: 1.50 m
Length: 1.72 m
Area: 2.58 m²
Perimeter: 6.44 m

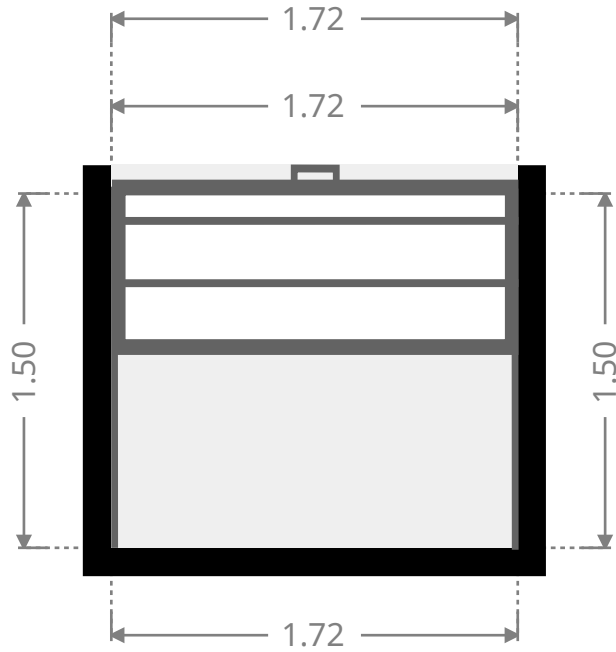
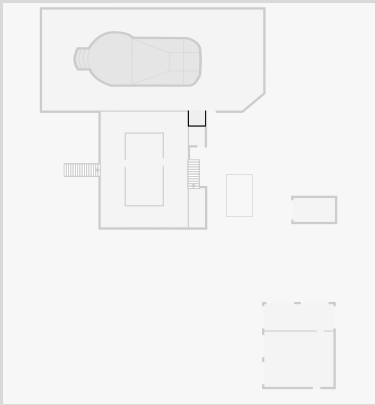

11 Ferguson Street

1st Floor

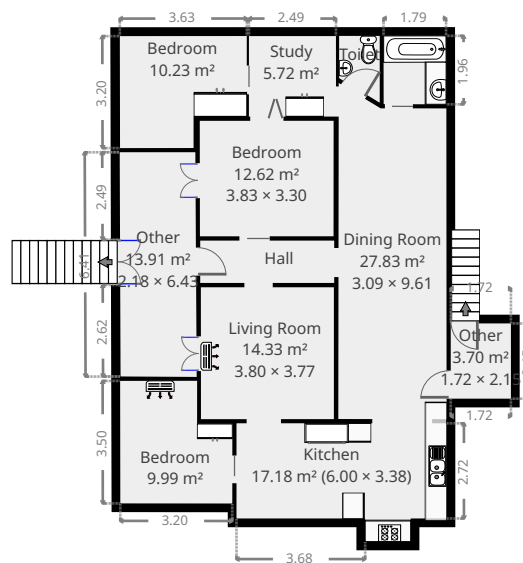

THIS FLOORPLAN IS PROVIDED WITHOUT WARRANTY OF ANY KIND. SENSOPIA DISCLAIMS ANY WARRANTY INCLUDING, WITHOUT LIMITATION, SATISFACTORY QUALITY OR ACCURACY OF DIMENSIONS.

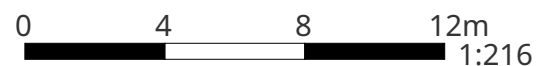

11 Ferguson Street

Hall

Width: 1.21 m
 Length: 3.83 m
 Area: 4.63 m²
 Perimeter: 10.08 m

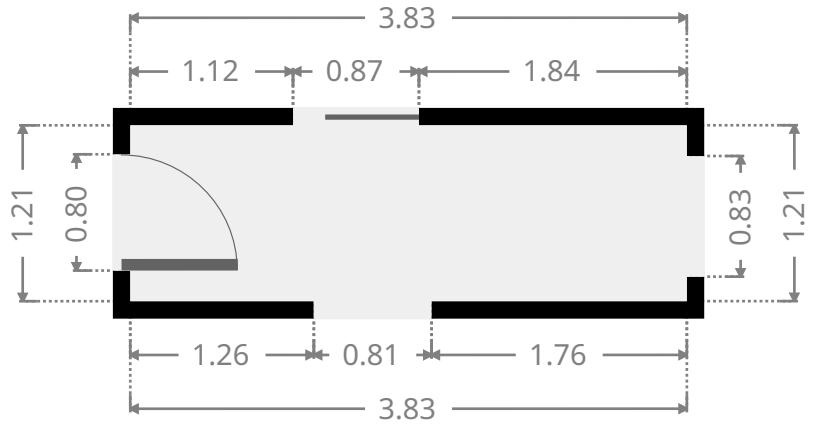
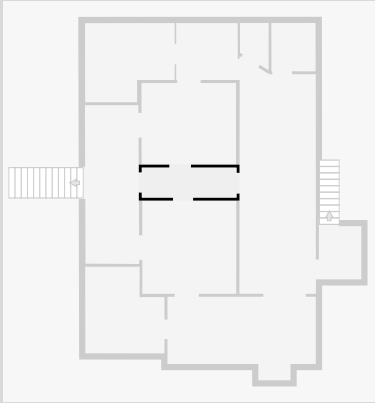

Bedroom

Width: 3.30 m
 Length: 3.83 m
 Area: 12.62 m²
 Perimeter: 14.25 m

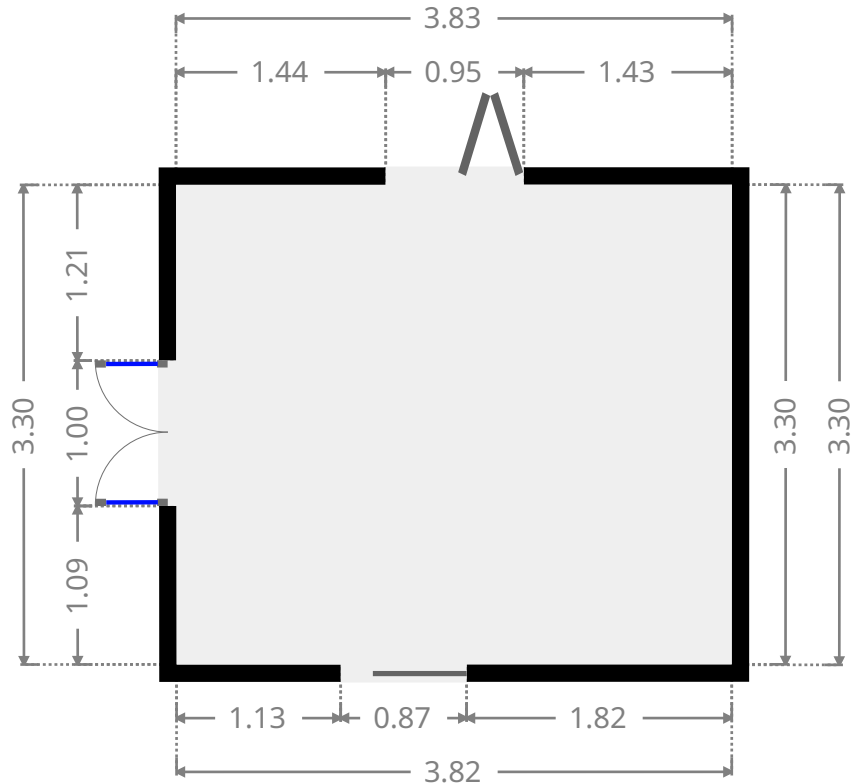
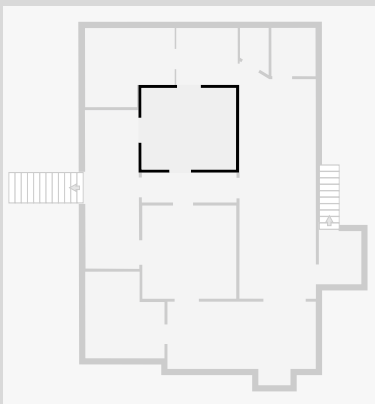

THIS FLOORPLAN IS PROVIDED WITHOUT WARRANTY OF ANY KIND. SENSOPIA DISCLAIMS ANY WARRANTY INCLUDING, WITHOUT LIMITATION, SATISFACTORY QUALITY OR ACCURACY OF DIMENSIONS.

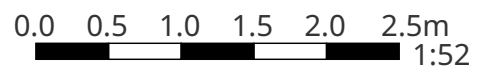

11 Ferguson Street

Living Room

Width: 3.77 m
 Length: 3.80 m
 Area: 14.33 m²
 Perimeter: 15.14 m

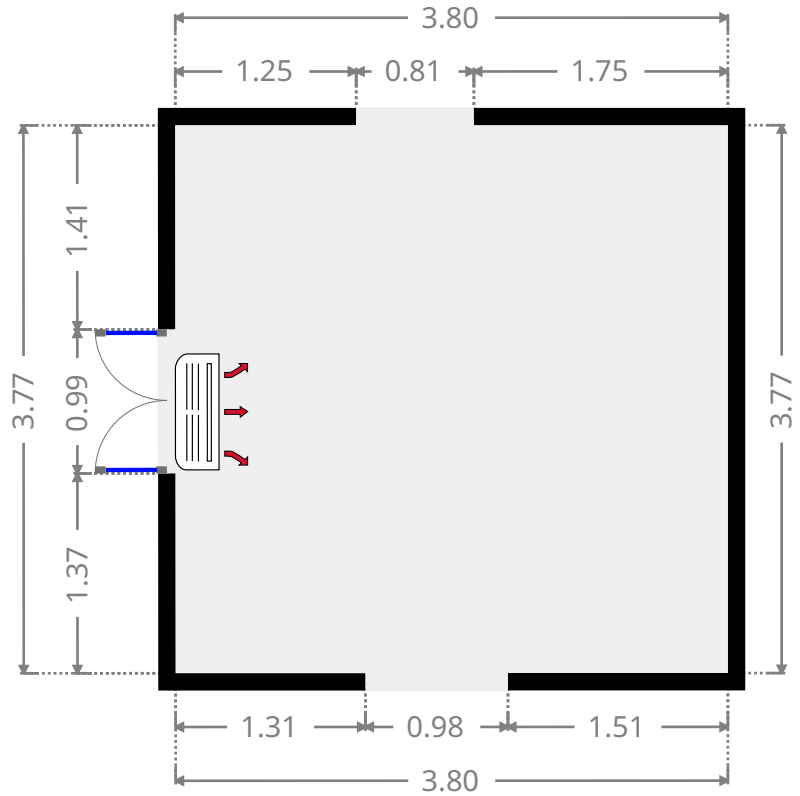
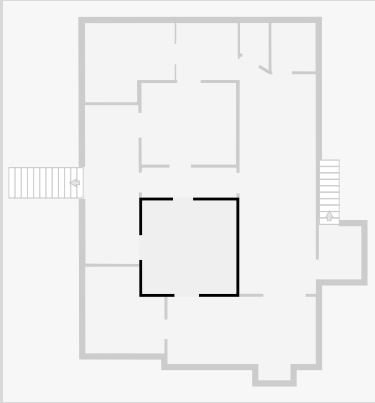

Study

Width: 2.30 m
 Length: 2.49 m
 Area: 5.72 m²
 Perimeter: 9.58 m

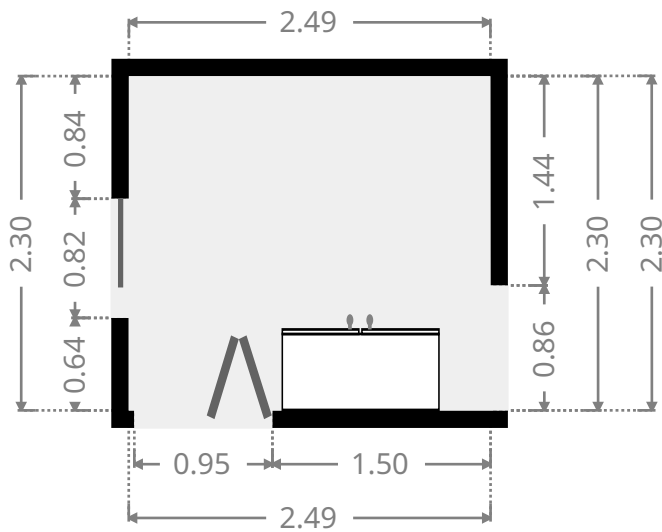
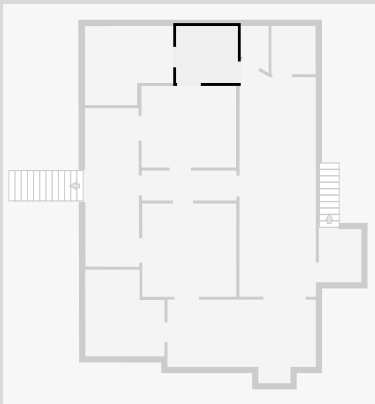

THIS FLOORPLAN IS PROVIDED WITHOUT WARRANTY OF ANY KIND. SENSOPIA DISCLAIMS ANY WARRANTY INCLUDING, WITHOUT LIMITATION, SATISFACTORY QUALITY OR ACCURACY OF DIMENSIONS.

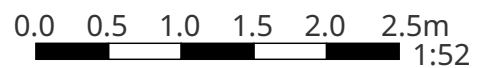

11 Ferguson Street

Bedroom

Width: 3.20 m
 Length: 3.63 m
 Area: 10.23 m²
 Perimeter: 13.65 m

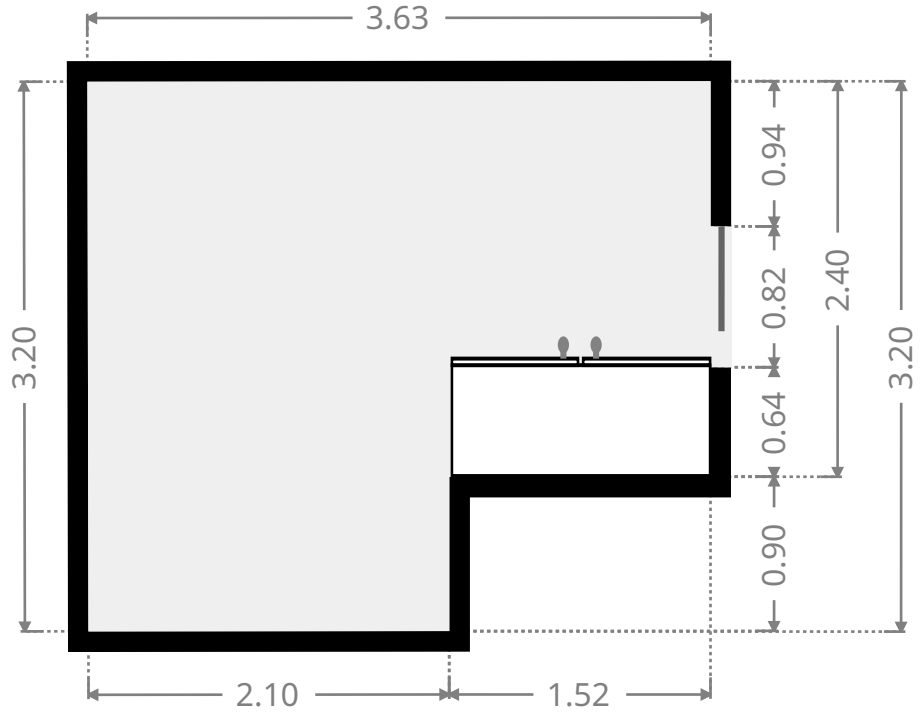
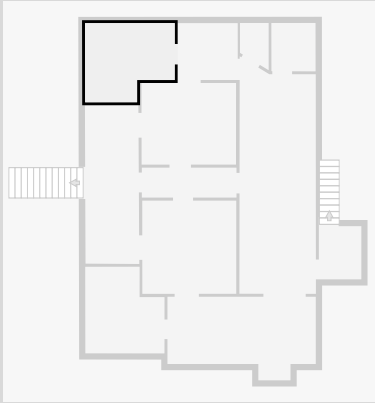

Toilet / Half Bath

Width: 1.16 m
 Length: 1.91 m
 Area: 1.81 m²
 Perimeter: 5.63 m

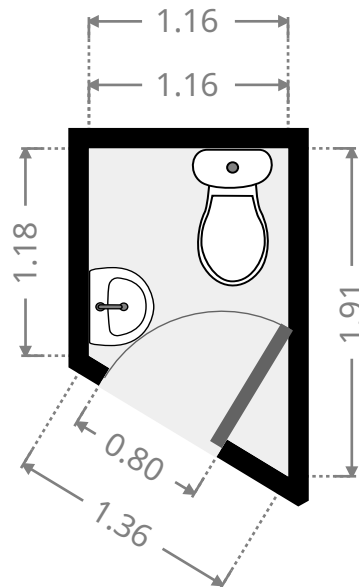
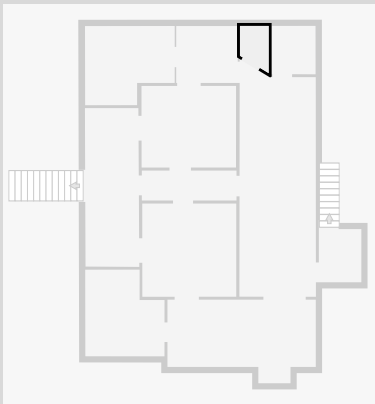

THIS FLOORPLAN IS PROVIDED WITHOUT WARRANTY OF ANY KIND. SENSOPIA DISCLAIMS ANY WARRANTY INCLUDING, WITHOUT LIMITATION, SATISFACTORY QUALITY OR ACCURACY OF DIMENSIONS.

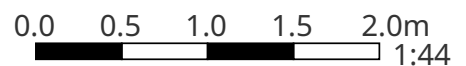

11 Ferguson Street

Dining Room

Width: 3.09 m
 Length: 9.61 m
 Area: 27.83 m²
 Perimeter: 24.86 m

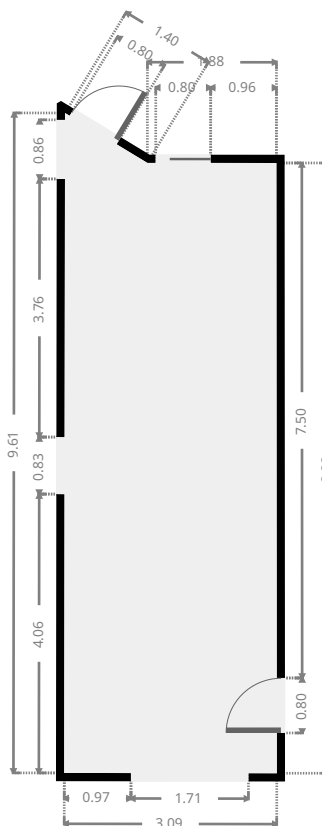
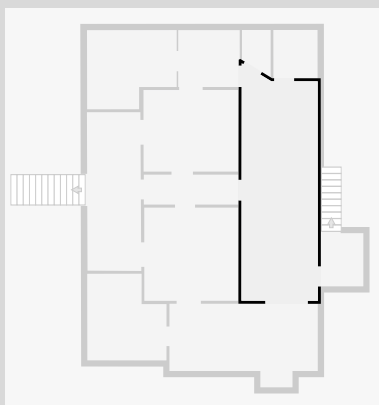

Bathroom

Width: 1.79 m
 Length: 1.96 m
 Area: 3.49 m²
 Perimeter: 7.48 m

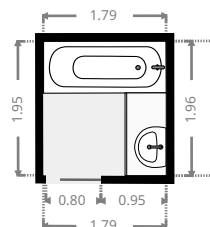
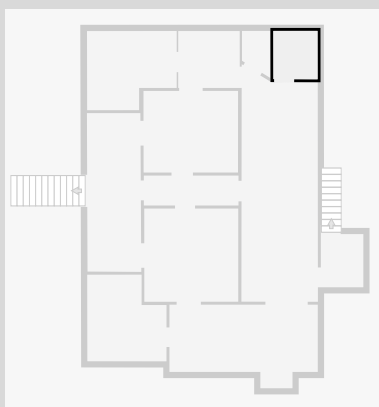

THIS FLOORPLAN IS PROVIDED WITHOUT WARRANTY OF ANY KIND. SENSOPIA DISCLAIMS ANY WARRANTY INCLUDING, WITHOUT LIMITATION, SATISFACTORY QUALITY OR ACCURACY OF DIMENSIONS.

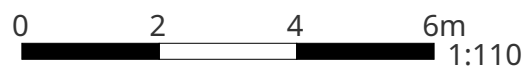

11 Ferguson Street

Kitchen

Width: 3.38 m
 Length: 6.00 m
 Area: 17.18 m²
 Perimeter: 18.76 m

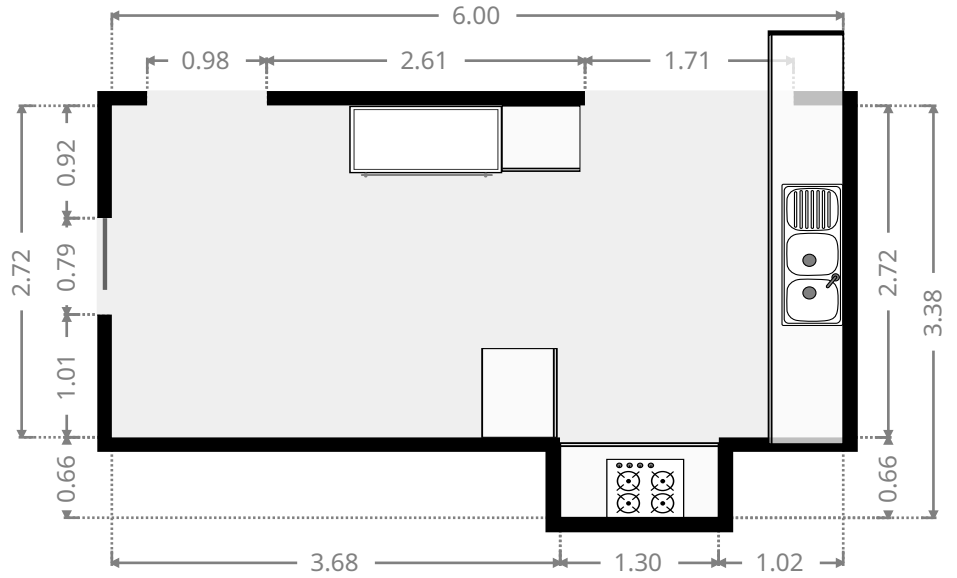
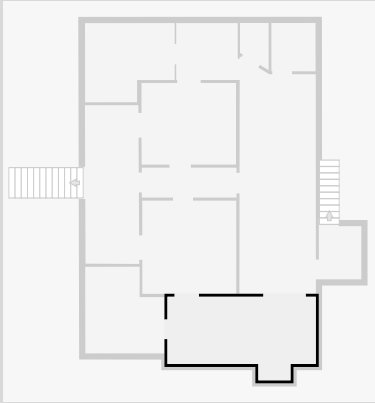

Bedroom

Width: 3.21 m
 Length: 3.51 m
 Area: 9.99 m²
 Perimeter: 13.41 m

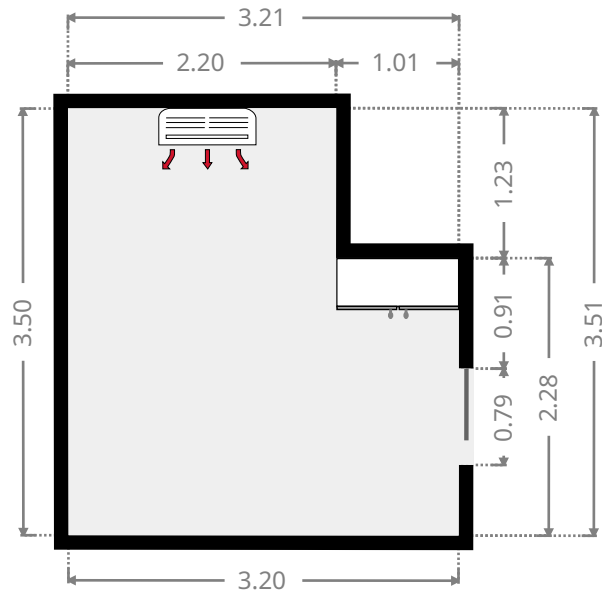
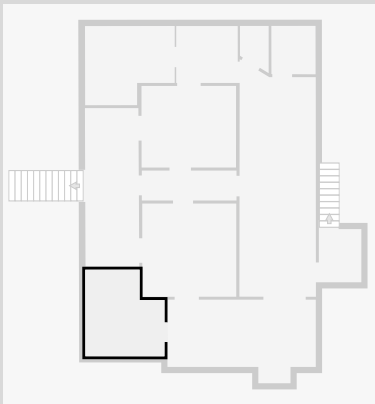

THIS FLOORPLAN IS PROVIDED WITHOUT WARRANTY OF ANY KIND. SENSOPIA DISCLAIMS ANY WARRANTY INCLUDING, WITHOUT LIMITATION, SATISFACTORY QUALITY OR ACCURACY OF DIMENSIONS.

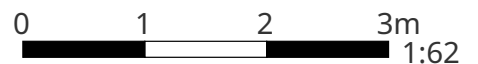

11 Ferguson Street

Other

Width: 2.18 m
 Length: 6.43 m
 Area: 13.91 m²
 Perimeter: 17.17 m

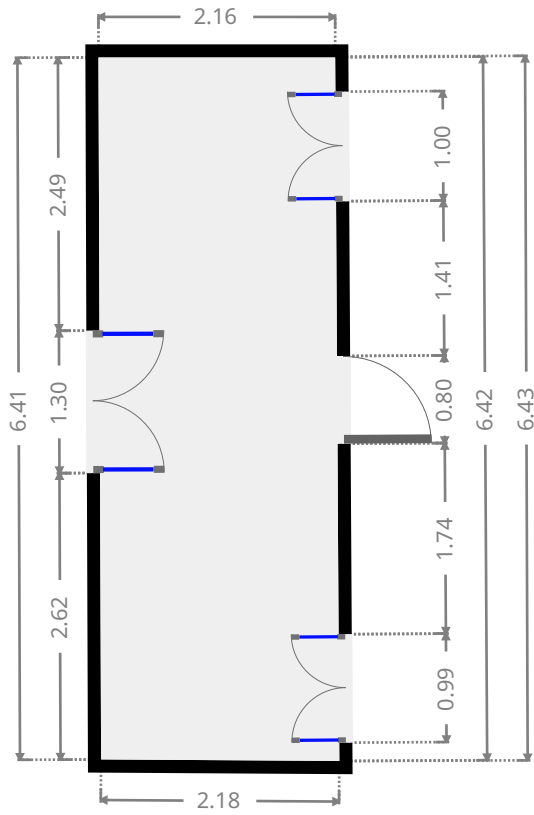
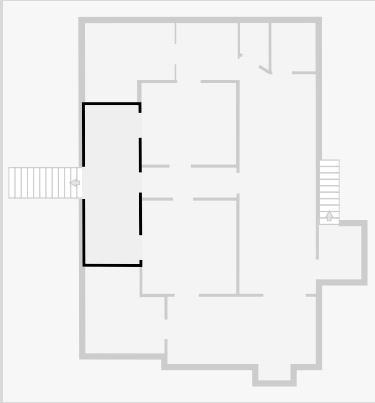

Other

Width: 1.72 m
 Length: 2.15 m
 Area: 3.70 m²
 Perimeter: 7.74 m

