

11 Davey Av

Ground Floor



THIS FLOORPLAN IS PROVIDED WITHOUT WARRANTY OF ANY KIND. SENSOPIA DISCLAIMS ANY WARRANTY INCLUDING, WITHOUT LIMITATION, SATISFACTORY QUALITY OR ACCURACY OF DIMENSIONS.



11 Davey Av

Bedroom

Width: 3.26 m
Length: 3.95 m
Area: 12.88 m²
Perimeter: 14.42 m

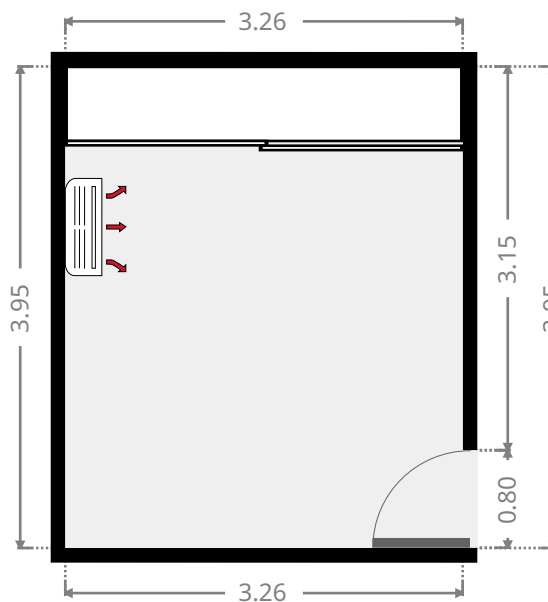
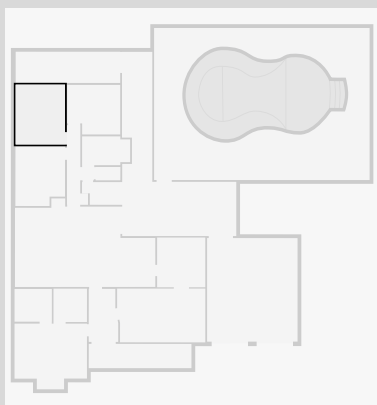

Other

Width: 1.60 m
Length: 6.78 m
Area: 10.86 m²
Perimeter: 16.76 m

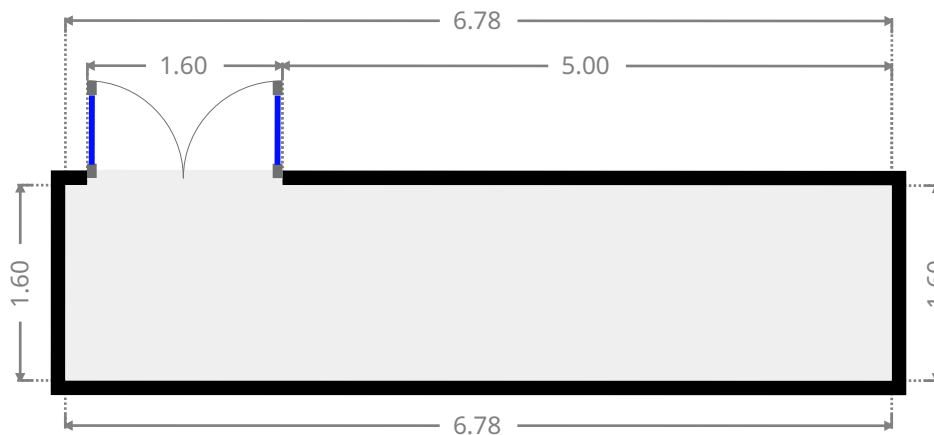

11 Davey Av

Other

Width: 10.04 m
Length: 14.23 m
Area: 142.78 m²
Perimeter: 48.53 m

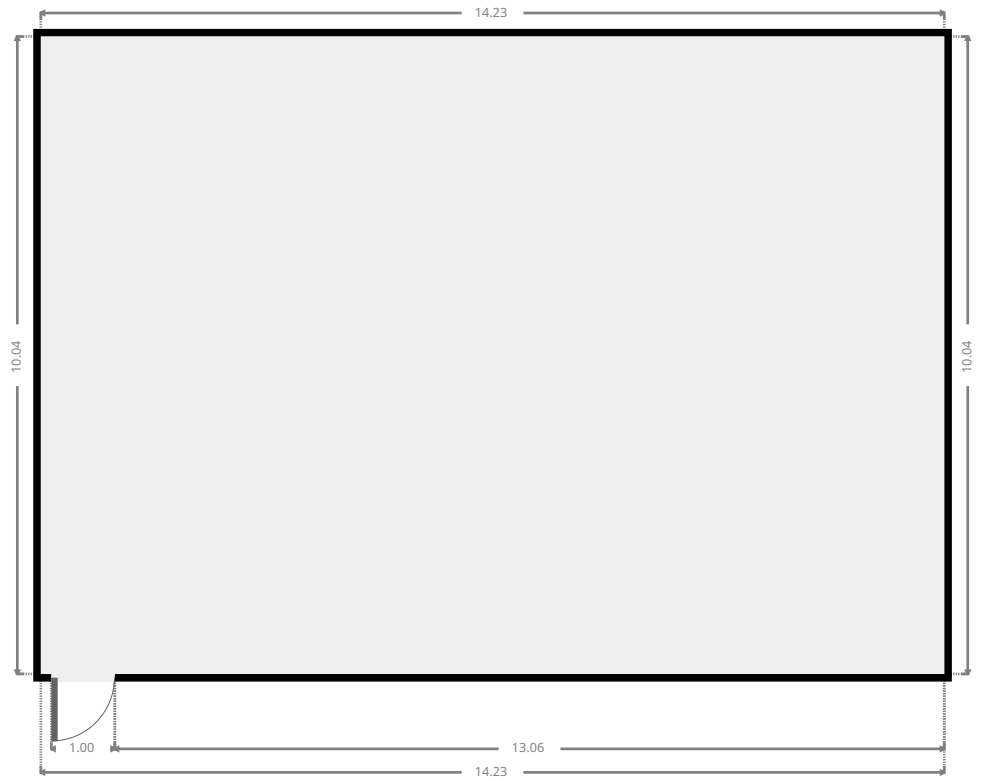
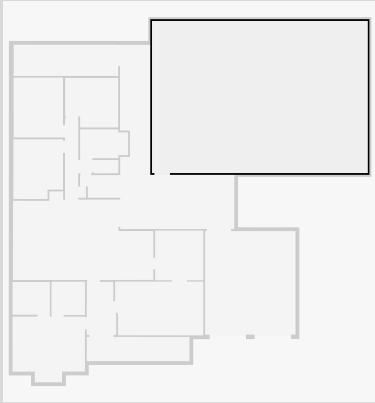

11 Davey Av

Garage

Width: 5.97 m
 Length: 6.84 m
 Area: 40.80 m²
 Perimeter: 25.61 m

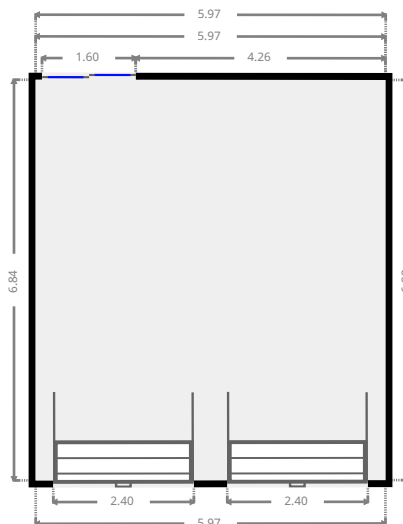
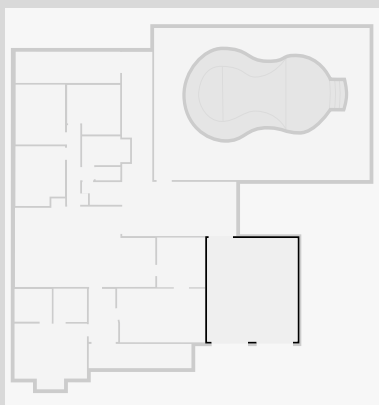

Other

Width: 7.54 m
 Length: 12.16 m
 Area: 42.96 m²
 Perimeter: 40.70 m

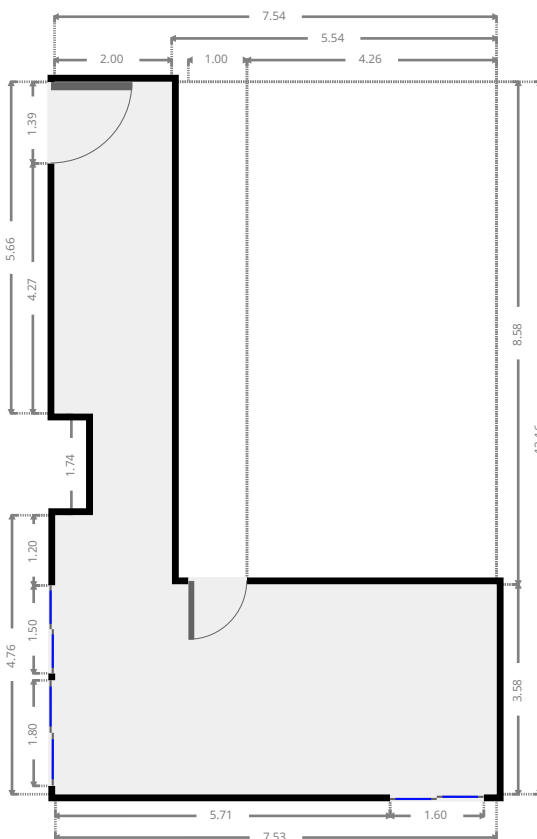
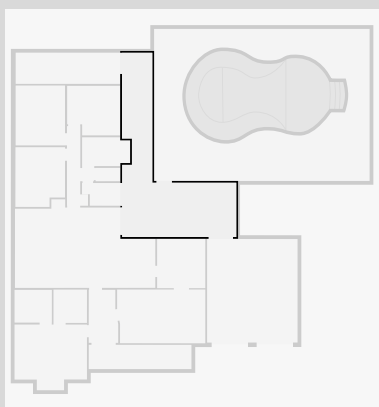

THIS FLOORPLAN IS PROVIDED WITHOUT WARRANTY OF ANY KIND. SENSOPIA DISCLAIMS ANY WARRANTY INCLUDING, WITHOUT LIMITATION, SATISFACTORY QUALITY OR ACCURACY OF DIMENSIONS.

11 Davey Av

Other

Width: 2.06 m
Length: 6.90 m
Area: 14.21 m²
Perimeter: 17.92 m

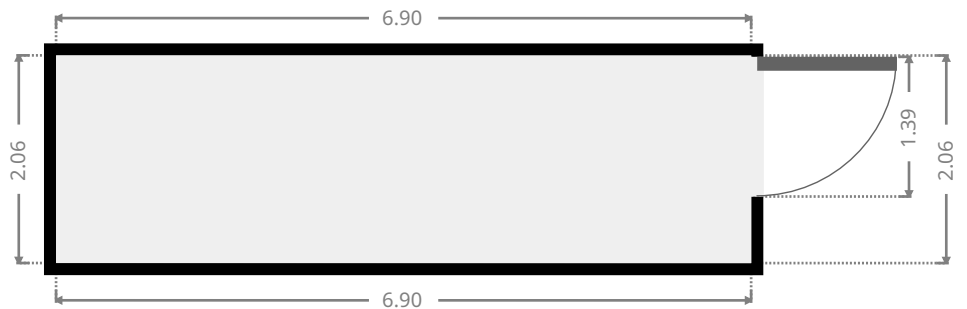
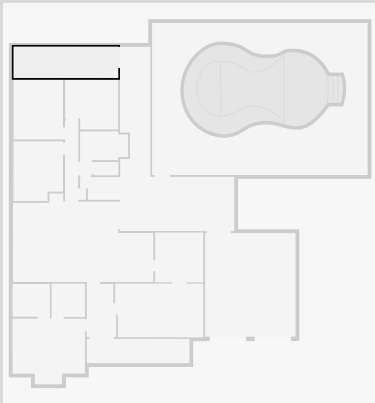

Laundry Room

Width: 1.50 m
Length: 2.53 m
Area: 3.40 m²
Perimeter: 8.06 m

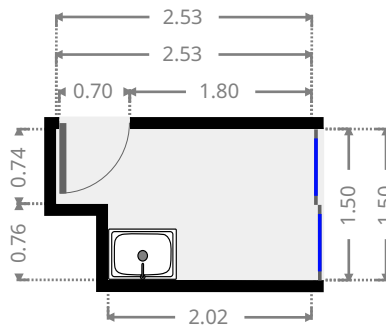
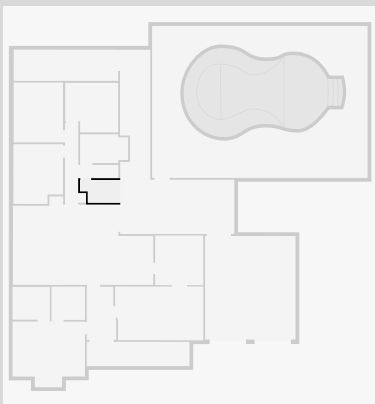

11 Davey Av

Toilet / Half Bath

Width: 0.88 m
 Length: 1.63 m
 Area: 1.43 m²
 Perimeter: 5.02 m

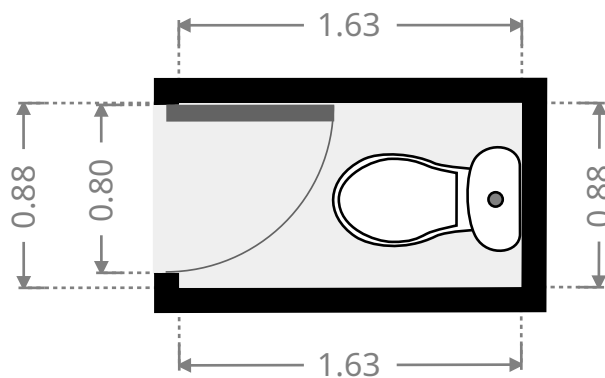
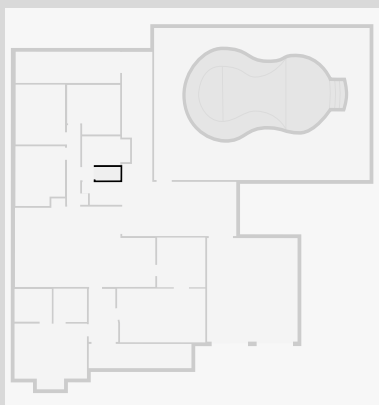

Bathroom

Width: 1.90 m
 Length: 3.17 m
 Area: 5.76 m²
 Perimeter: 10.14 m

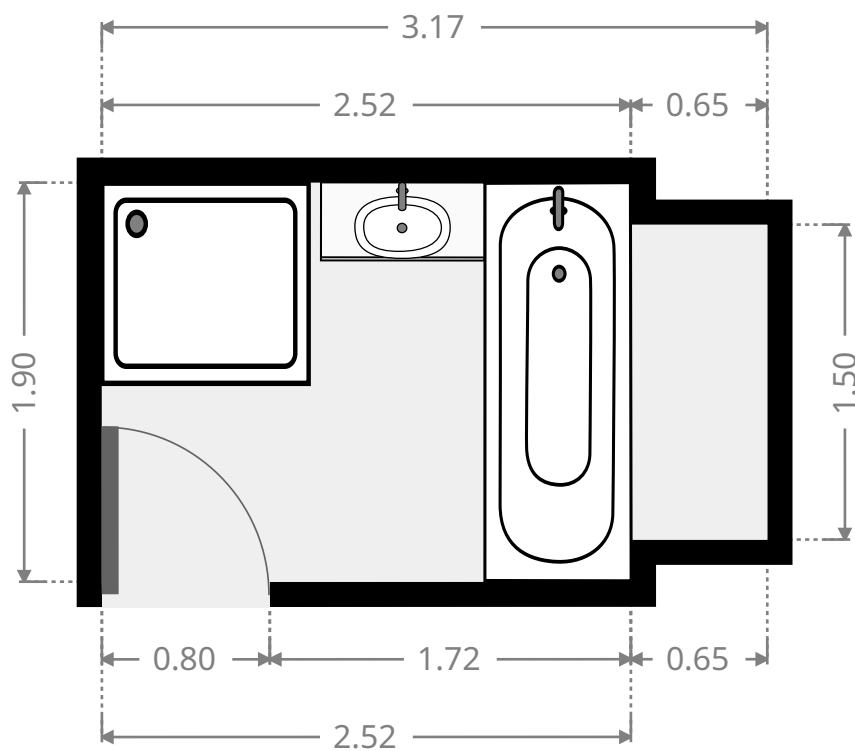
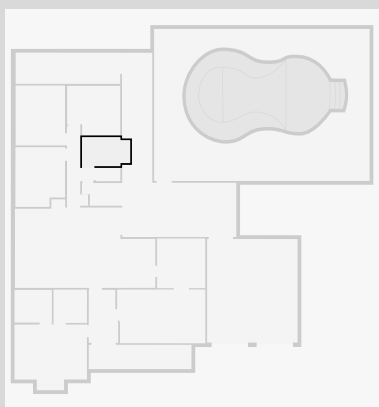

THIS FLOORPLAN IS PROVIDED WITHOUT WARRANTY OF ANY KIND. SENSOPIA DISCLAIMS ANY WARRANTY INCLUDING, WITHOUT LIMITATION, SATISFACTORY QUALITY OR ACCURACY OF DIMENSIONS.

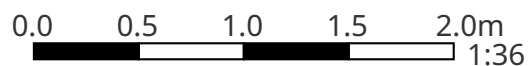

11 Davey Av

Bedroom

Width: 3.27 m
 Length: 3.50 m
 Area: 10.72 m²
 Perimeter: 13.54 m

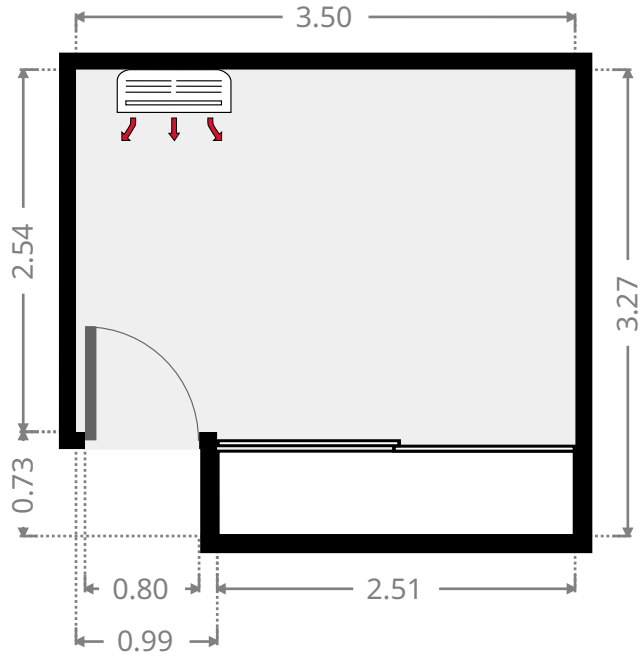
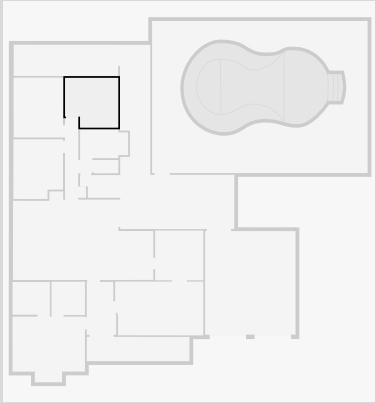

Hall

Width: 1.95 m
 Length: 3.50 m
 Area: 6.47 m²
 Perimeter: 10.72 m

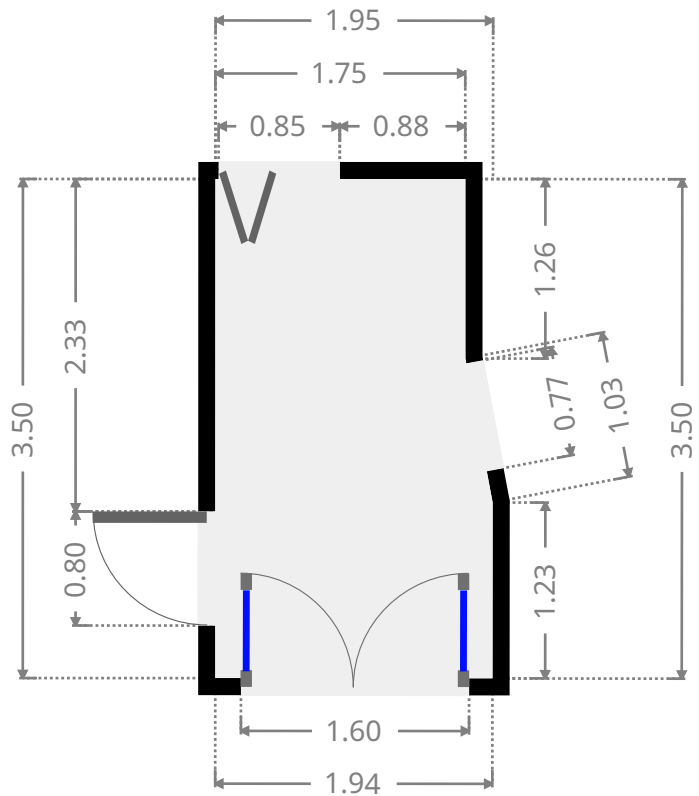
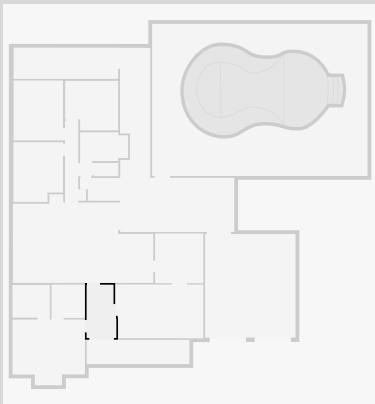

THIS FLOORPLAN IS PROVIDED WITHOUT WARRANTY OF ANY KIND. SENSOPIA DISCLAIMS ANY WARRANTY INCLUDING, WITHOUT LIMITATION, SATISFACTORY QUALITY OR ACCURACY OF DIMENSIONS.

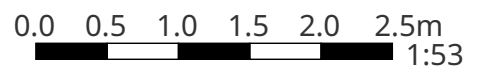

11 Davey Av

Bedroom

Width: 3.28 m
 Length: 3.94 m
 Area: 12.27 m²
 Perimeter: 14.43 m

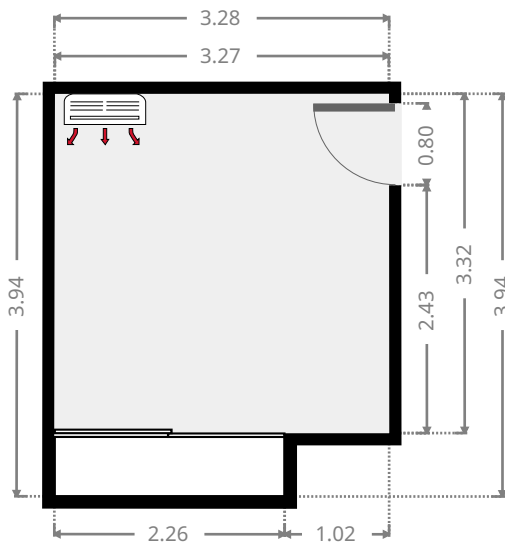
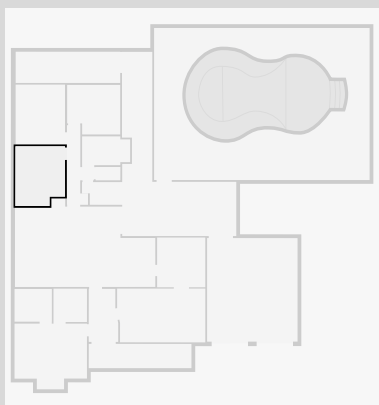

Hall

Width: 1.77 m
 Length: 5.25 m
 Area: 5.76 m²
 Perimeter: 15.08 m

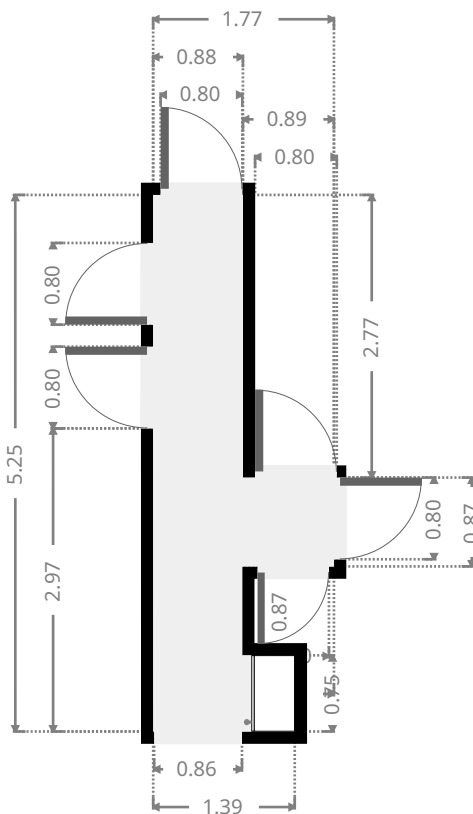
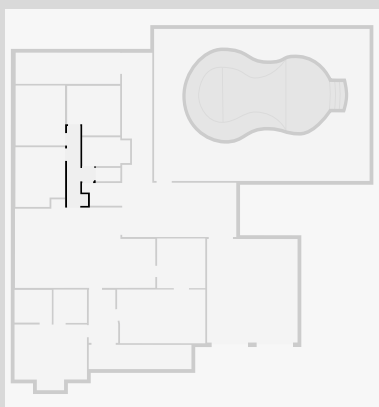

THIS FLOORPLAN IS PROVIDED WITHOUT WARRANTY OF ANY KIND. SENSOPIA DISCLAIMS ANY WARRANTY INCLUDING, WITHOUT LIMITATION, SATISFACTORY QUALITY OR ACCURACY OF DIMENSIONS.

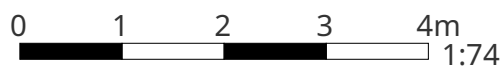

11 Davey Av

Kitchen

Width: 5.85 m
 Length: 9.27 m
 Area: 44.66 m²
 Perimeter: 30.21 m

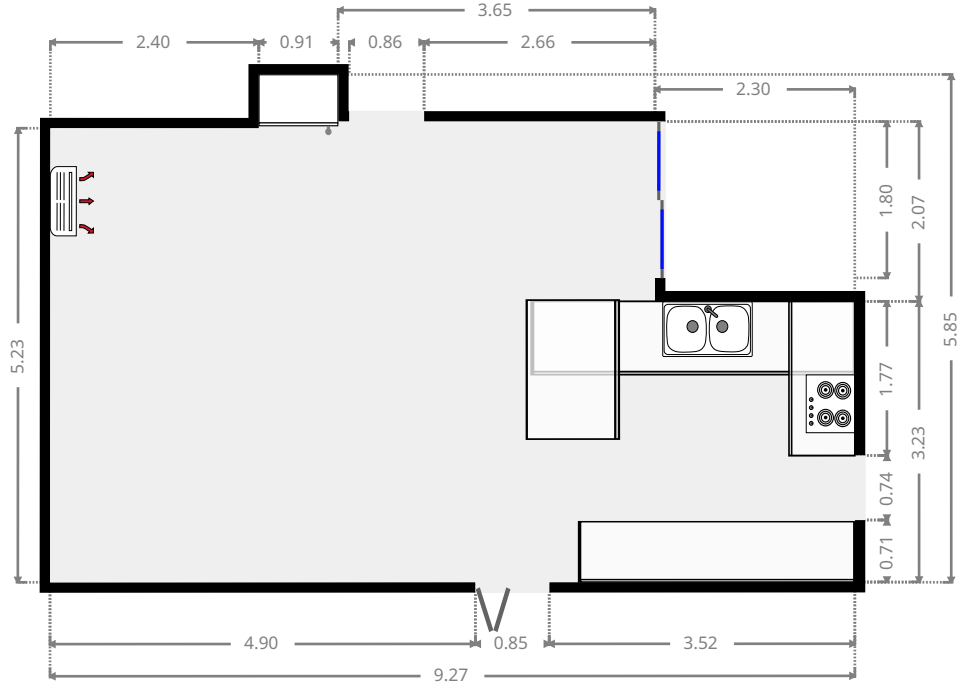
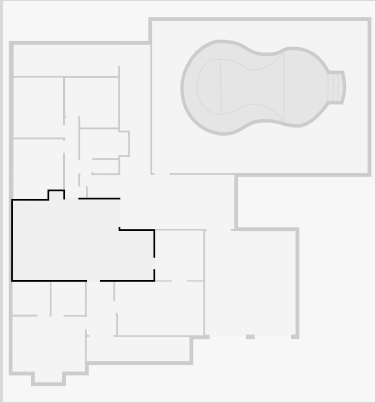

Dining Room

Width: 3.18 m
 Length: 3.28 m
 Area: 10.43 m²
 Perimeter: 12.92 m

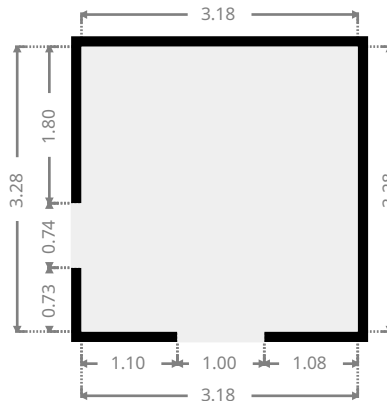
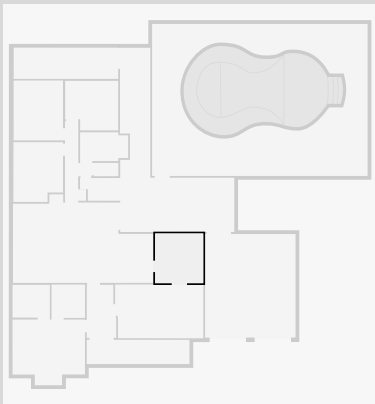

THIS FLOORPLAN IS PROVIDED WITHOUT WARRANTY OF ANY KIND. SENSOPIA DISCLAIMS ANY WARRANTY INCLUDING, WITHOUT LIMITATION, SATISFACTORY QUALITY OR ACCURACY OF DIMENSIONS.



11 Davey Av

Closet

Width: 2.20 m
Length: 2.21 m
Area: 4.86 m²
Perimeter: 8.82 m

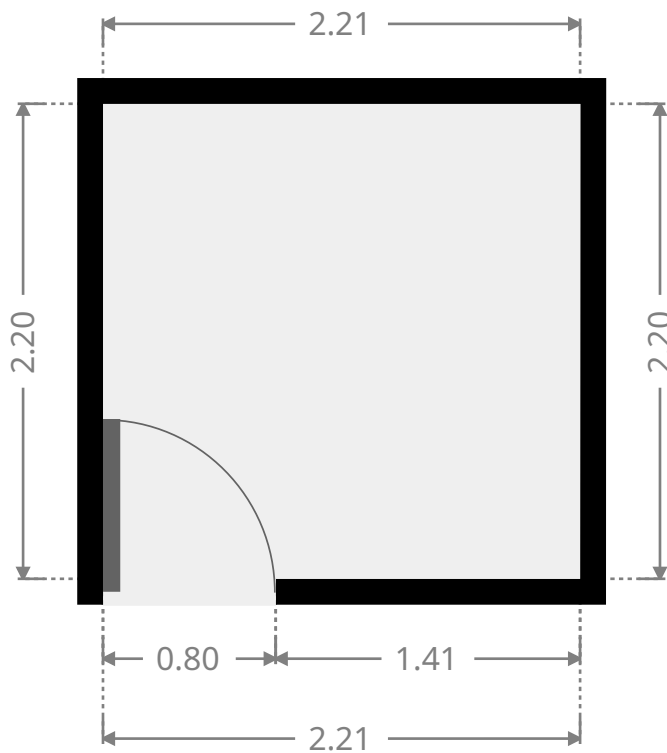
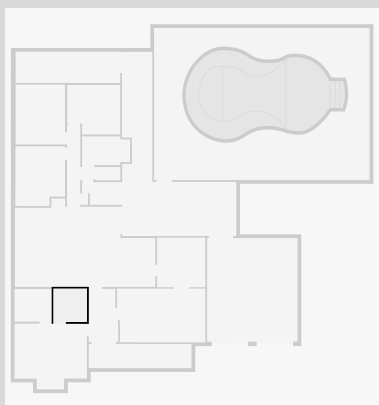

Bathroom

Width: 2.16 m
Length: 2.46 m
Area: 5.31 m²
Perimeter: 9.24 m

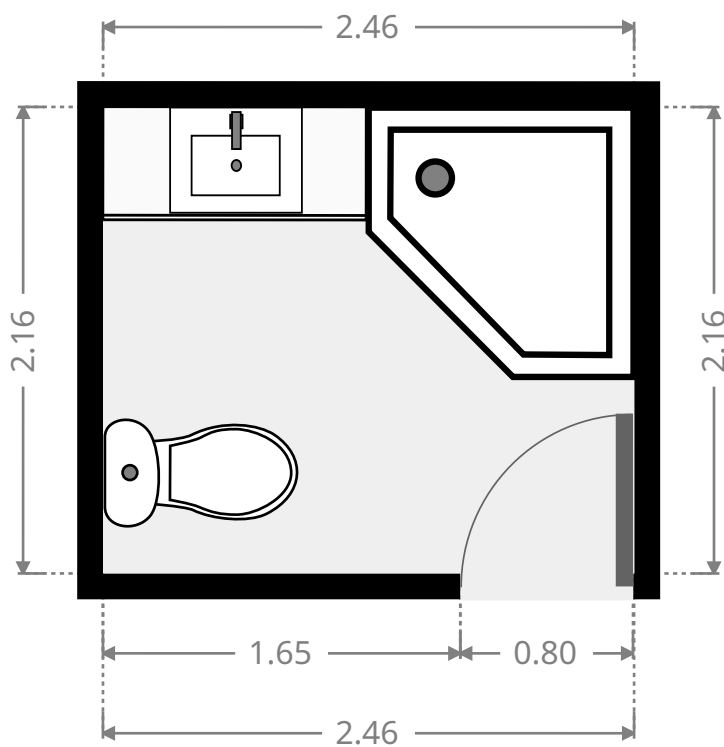
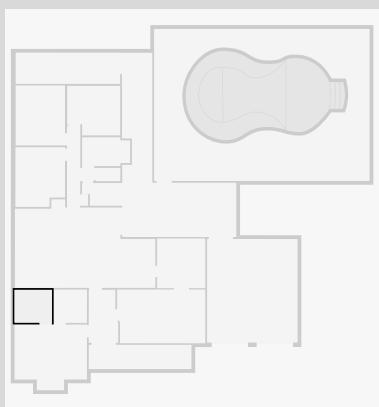

THIS FLOORPLAN IS PROVIDED WITHOUT WARRANTY OF ANY KIND. SENSOPIA DISCLAIMS ANY WARRANTY INCLUDING, WITHOUT LIMITATION, SATISFACTORY QUALITY OR ACCURACY OF DIMENSIONS.

