

11 Carara Drive

Ground Floor

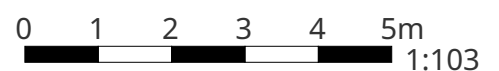

THIS FLOORPLAN IS PROVIDED WITHOUT WARRANTY OF ANY KIND. SENSOPIA DISCLAIMS ANY WARRANTY INCLUDING, WITHOUT LIMITATION, SATISFACTORY QUALITY OR ACCURACY OF DIMENSIONS.



11 Carara Drive

Kitchen/Dining

Width: 5.50 m
 Length: 6.26 m
 Area: 26.69 m²
 Perimeter: 23.51 m

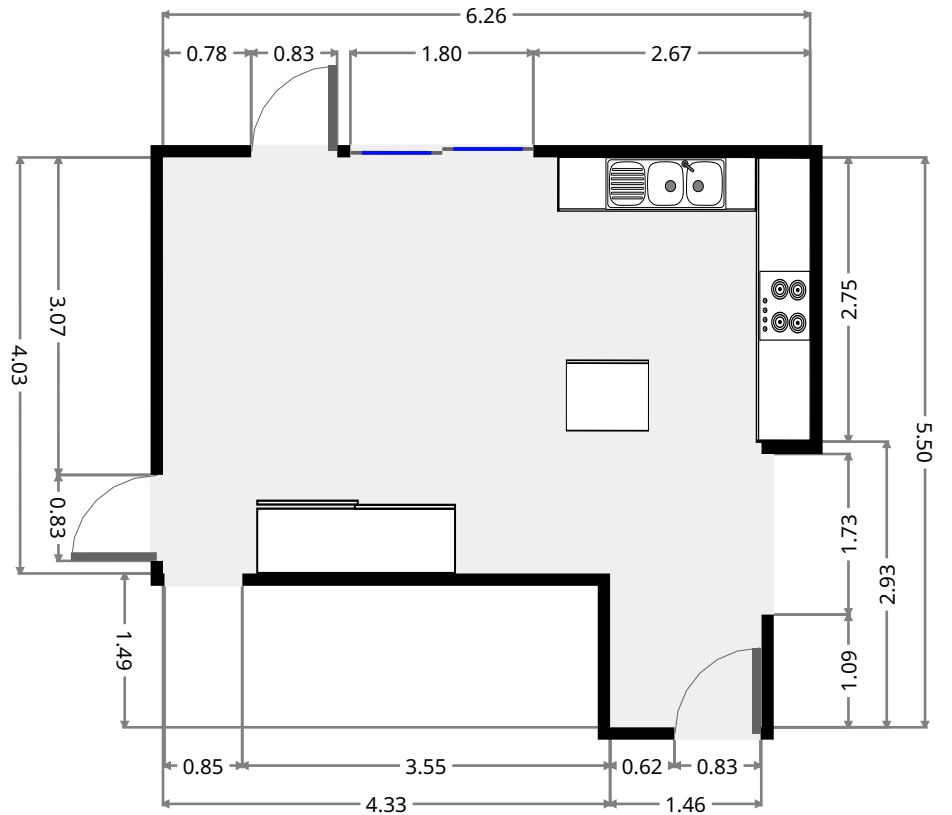
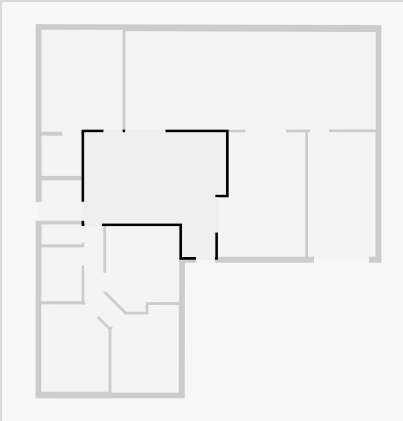

Living Room

Width: 3.86 m
 Length: 5.49 m
 Area: 19.82 m²
 Perimeter: 18.70 m

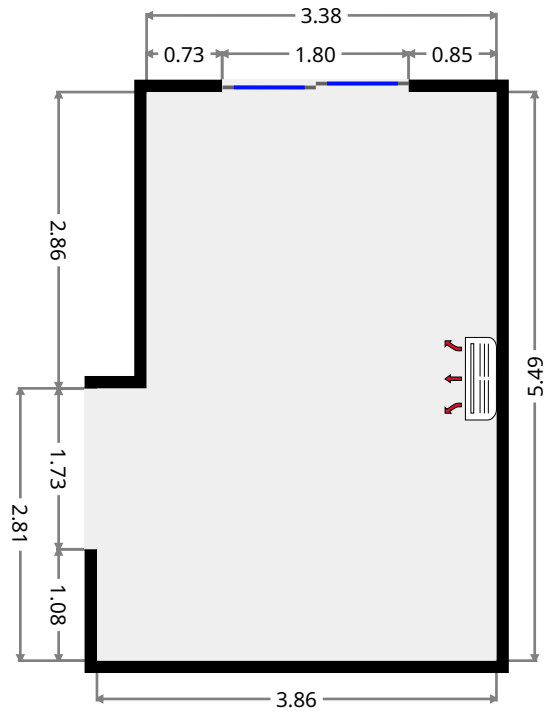
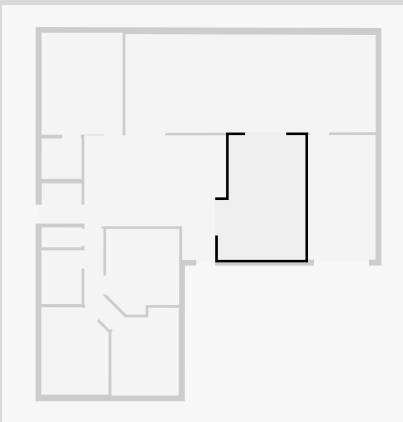

THIS FLOORPLAN IS PROVIDED WITHOUT WARRANTY OF ANY KIND. SENSOPIA DISCLAIMS ANY WARRANTY INCLUDING, WITHOUT LIMITATION, SATISFACTORY QUALITY OR ACCURACY OF DIMENSIONS.

11 Carara Drive

Master Bedroom

Width: 3.58 m
Length: 4.51 m
Area: 16.11 m²
Perimeter: 16.16 m

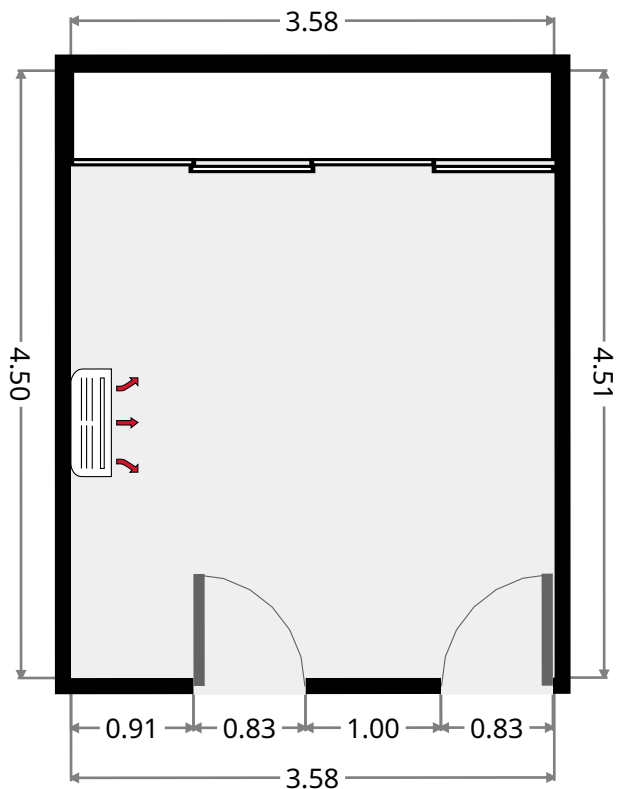
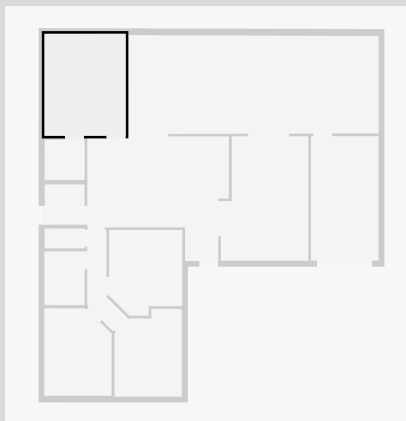

Ensuite

Width: 1.77 m
Length: 1.77 m
Area: 3.14 m²
Perimeter: 7.09 m

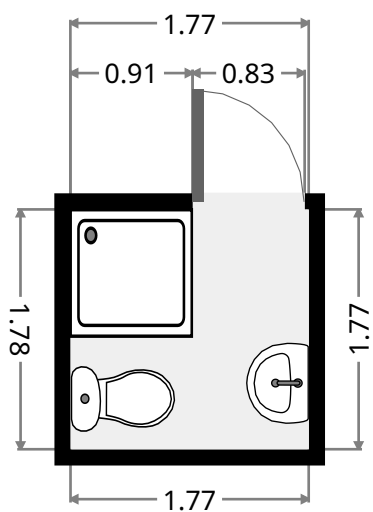
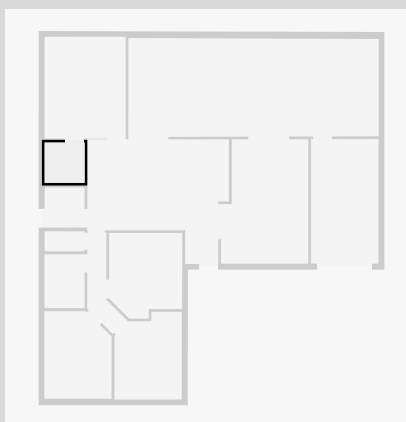

11 Carara Drive

Laundry Room

Width: 1.76 m
 Length: 1.77 m
 Area: 3.12 m²
 Perimeter: 7.07 m

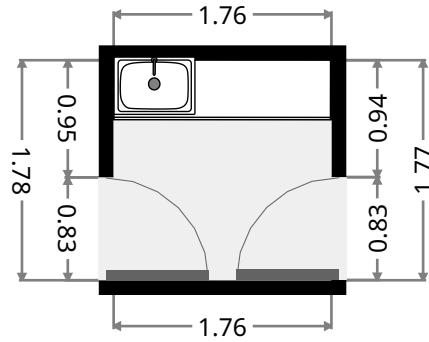
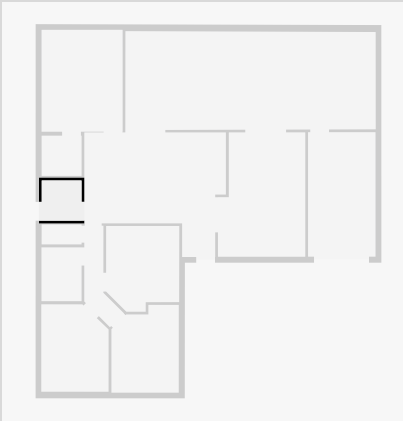

Hall

Width: 0.85 m
 Length: 3.35 m
 Area: 3.92 m²
 Perimeter: 10.92 m

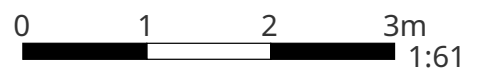
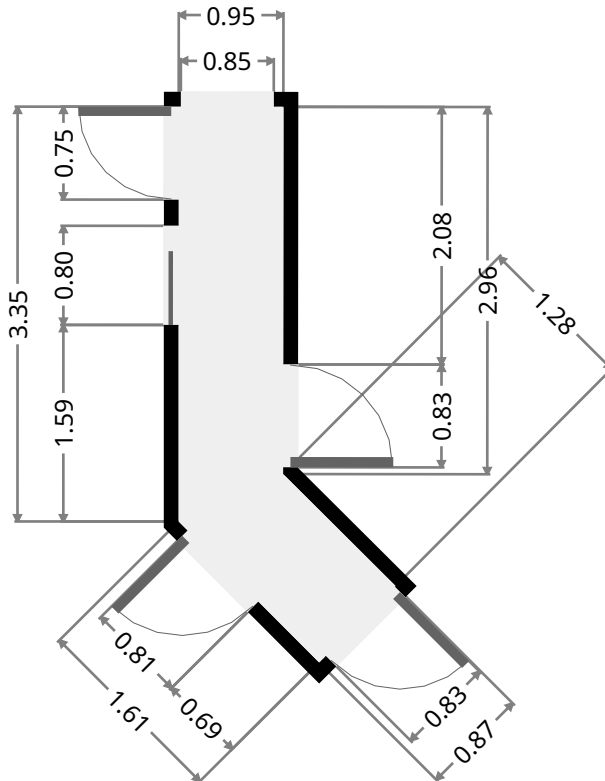
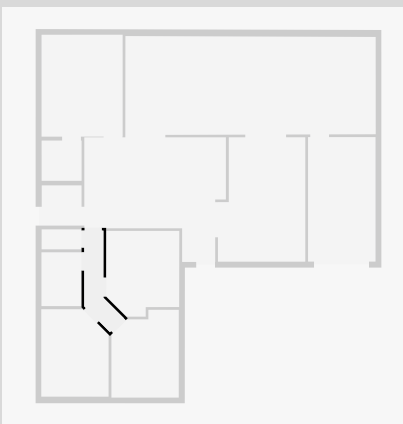

THIS FLOORPLAN IS PROVIDED WITHOUT WARRANTY OF ANY KIND. SENSOPIA DISCLAIMS ANY WARRANTY INCLUDING, WITHOUT LIMITATION, SATISFACTORY QUALITY OR ACCURACY OF DIMENSIONS.

11 Carara Drive

Toilet

Width: 0.88 m
Length: 1.77 m
Area: 1.55 m²
Perimeter: 5.29 m

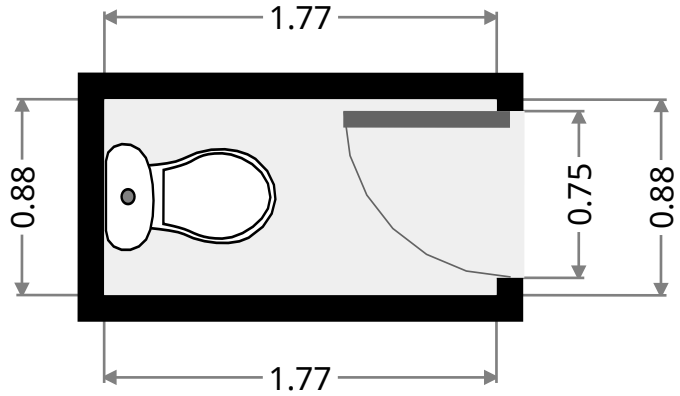
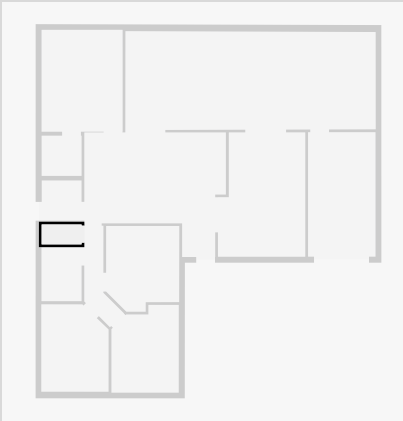

Bathroom

Width: 1.77 m
Length: 2.37 m
Area: 4.21 m²
Perimeter: 8.30 m

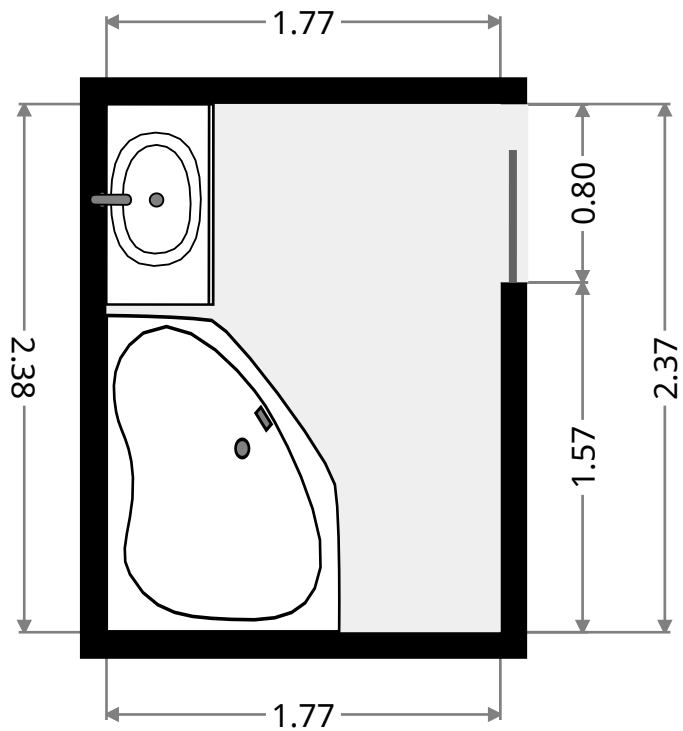
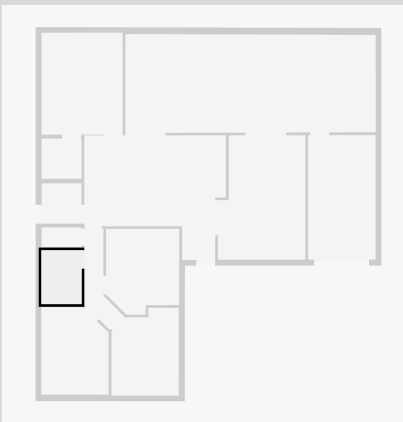

11 Carara Drive

Bedroom

Width: 2.98 m
 Length: 3.87 m
 Area: 10.83 m²
 Perimeter: 13.00 m

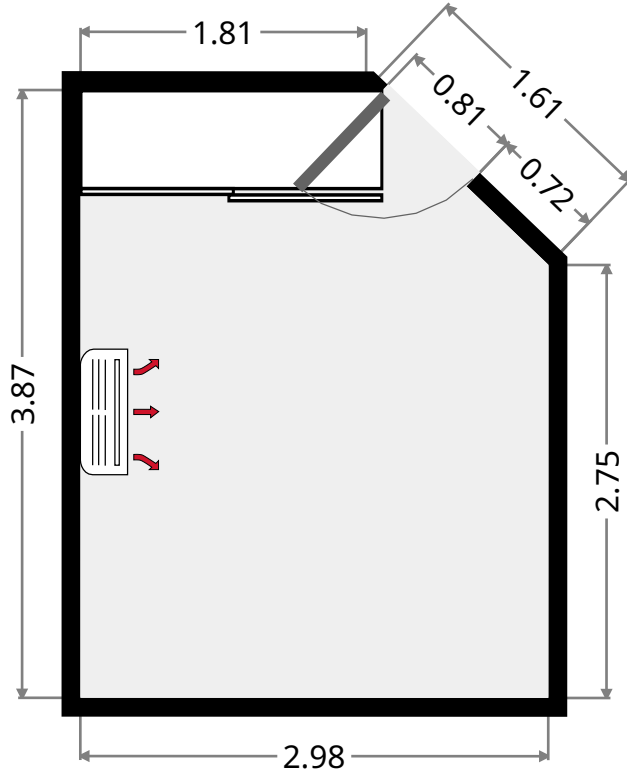
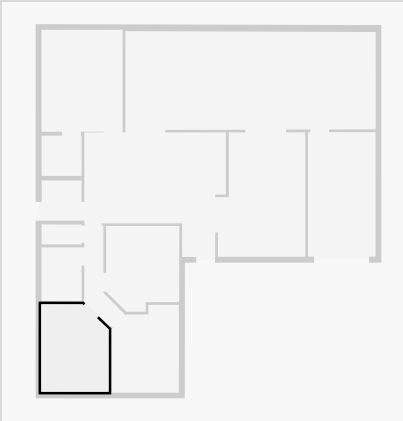

Bedroom

Width: 2.97 m
 Length: 3.88 m
 Area: 10.63 m²
 Perimeter: 13.32 m

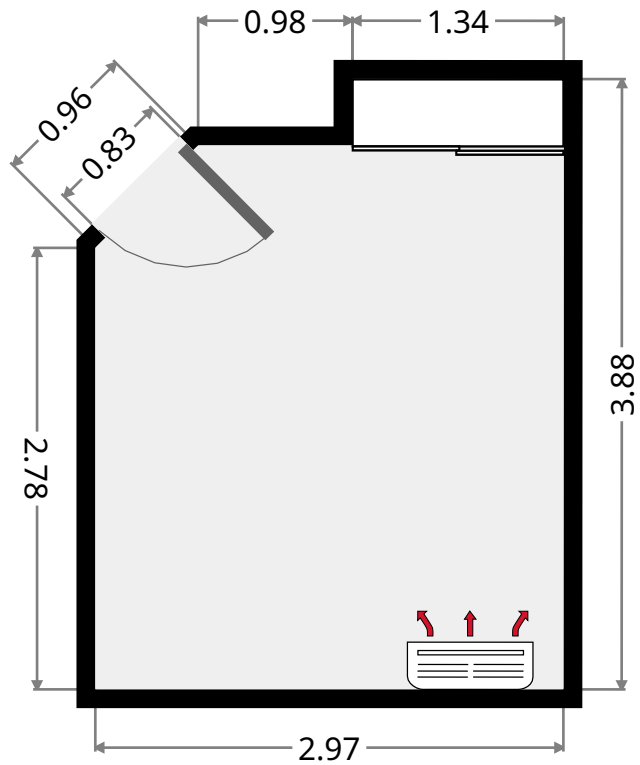
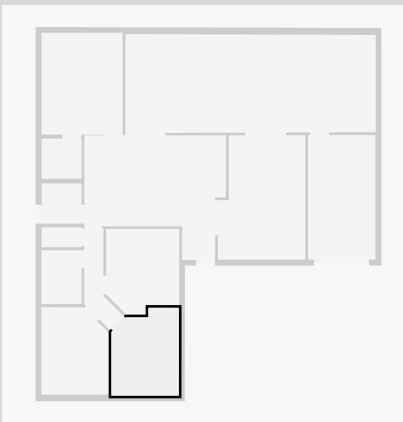

THIS FLOORPLAN IS PROVIDED WITHOUT WARRANTY OF ANY KIND. SENSOPIA DISCLAIMS ANY WARRANTY INCLUDING, WITHOUT LIMITATION, SATISFACTORY QUALITY OR ACCURACY OF DIMENSIONS.

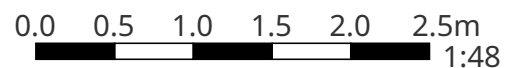

11 Carara Drive

Bedroom

Width: 3.23 m
Length: 3.78 m
Area: 11.20 m²
Perimeter: 13.50 m

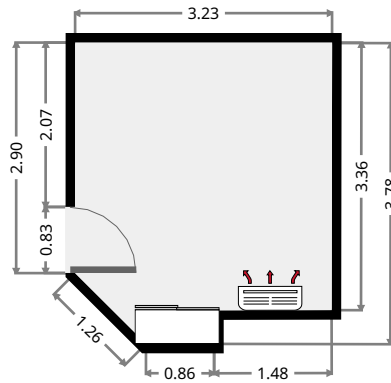
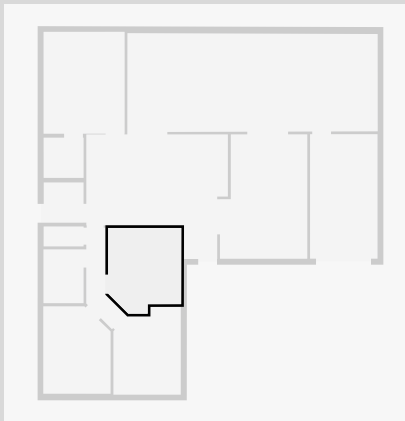

Outdoor Area

Width: 4.37 m
Length: 11.07 m
Area: 47.91 m²
Perimeter: 30.78 m

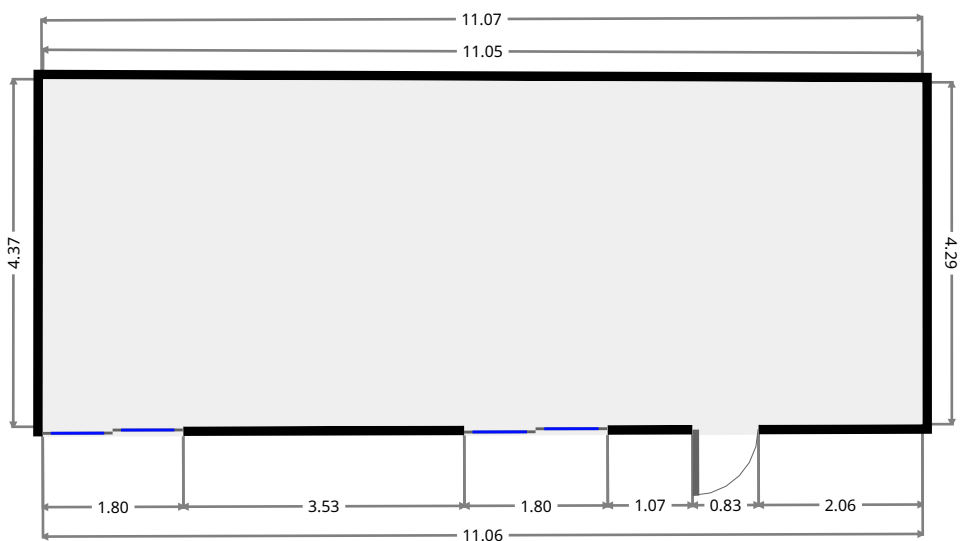
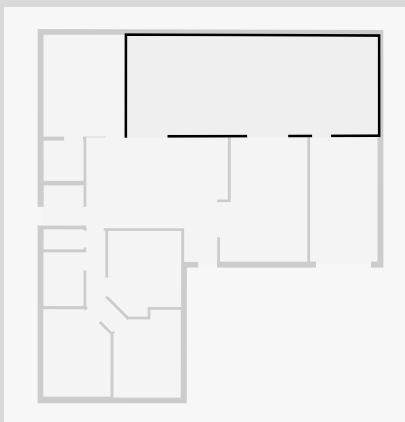

11 Carara Drive

Garage

Width: 2.98 m
Length: 5.50 m
Area: 16.38 m²
Perimeter: 16.96 m

