

11 Brady Place

Ground Floor

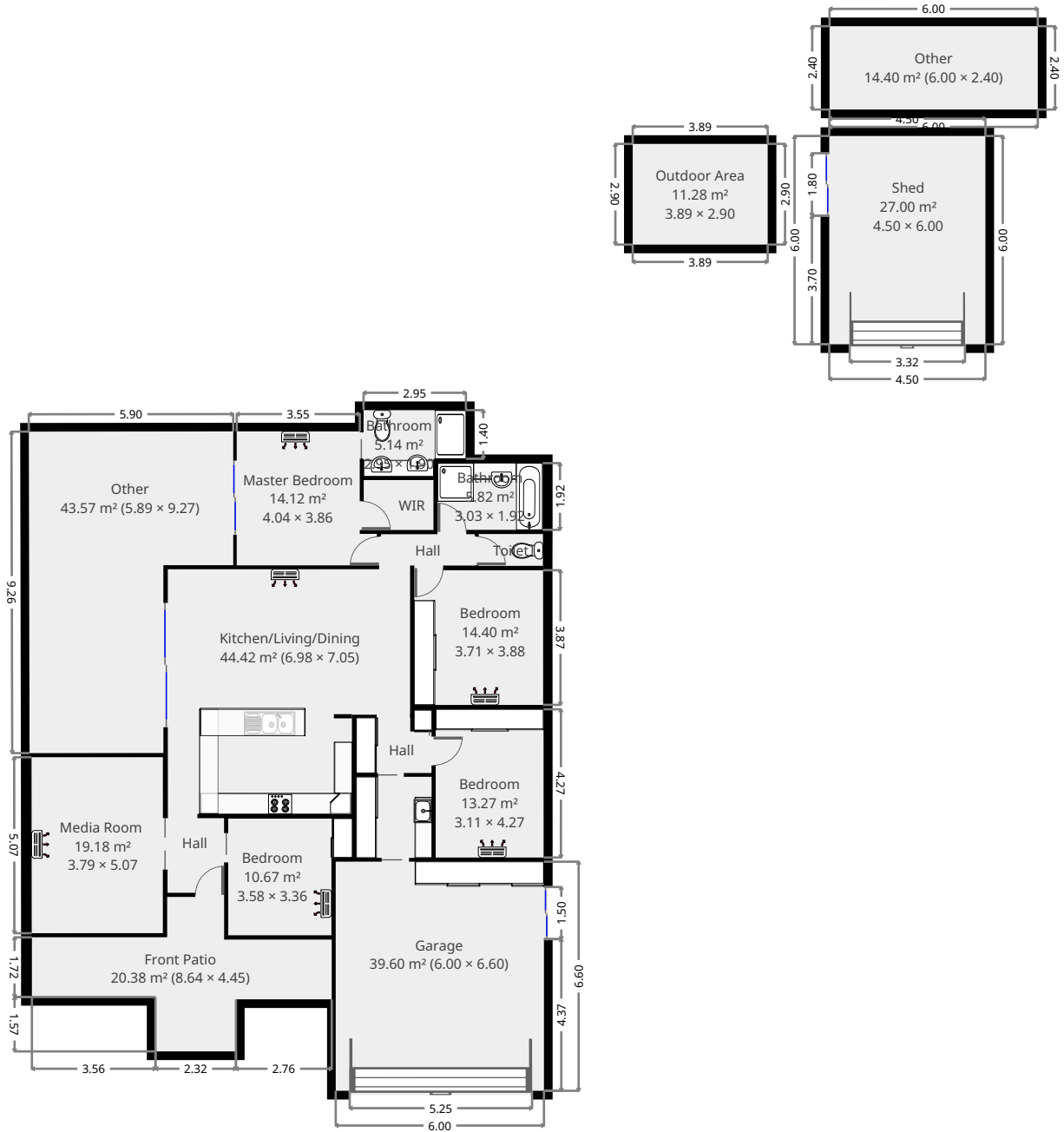

THIS FLOORPLAN IS PROVIDED WITHOUT WARRANTY OF ANY KIND. SENSOPIA DISCLAIMS ANY WARRANTY INCLUDING, WITHOUT LIMITATION, SATISFACTORY QUALITY OR ACCURACY OF DIMENSIONS.



11 Brady Place

Toilet / Half Bath

Width: 0.92 m
 Length: 1.85 m
 Area: 1.70 m²
 Perimeter: 5.53 m

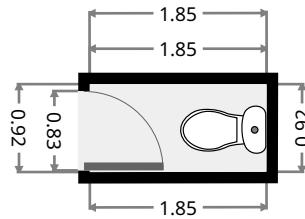
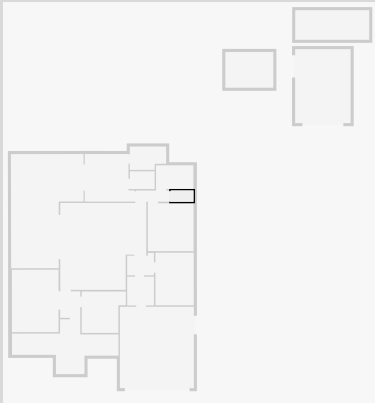

Front Patio

Width: 4.45 m
 Length: 8.64 m
 Area: 20.38 m²
 Perimeter: 26.18 m

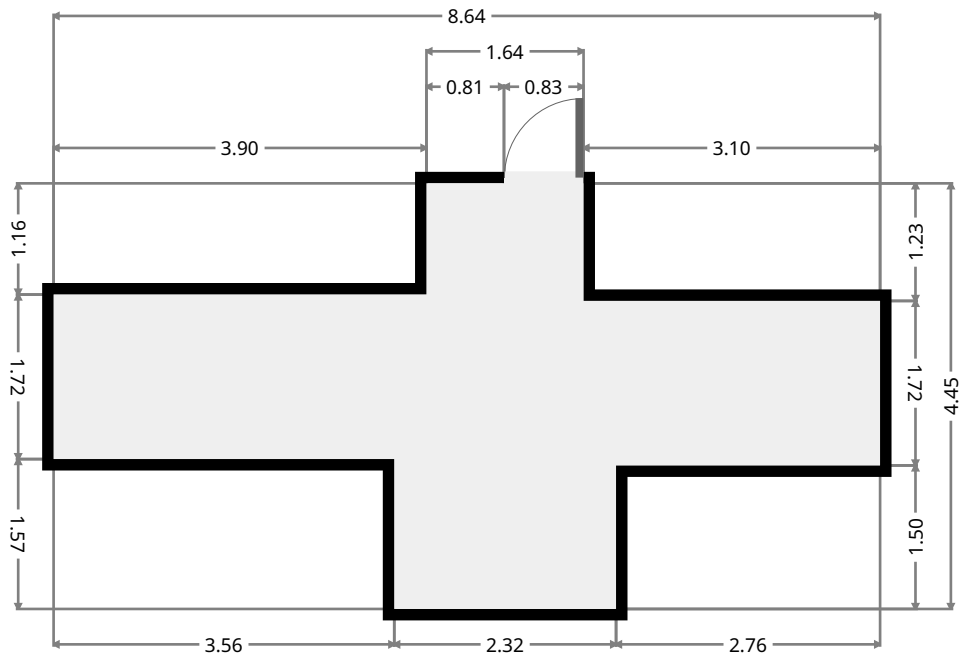
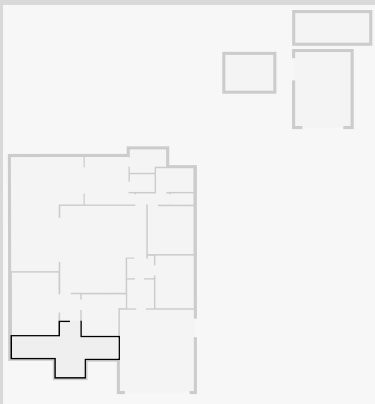

THIS FLOORPLAN IS PROVIDED WITHOUT WARRANTY OF ANY KIND. SENSOPIA DISCLAIMS ANY WARRANTY INCLUDING, WITHOUT LIMITATION, SATISFACTORY QUALITY OR ACCURACY OF DIMENSIONS.

11 Brady Place

Other

Width: 2.40 m
Length: 6.00 m
Area: 14.40 m²
Perimeter: 16.80 m

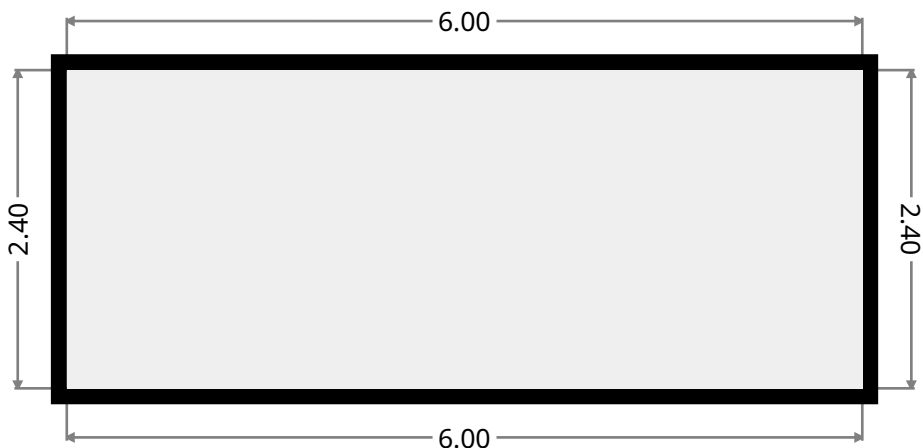
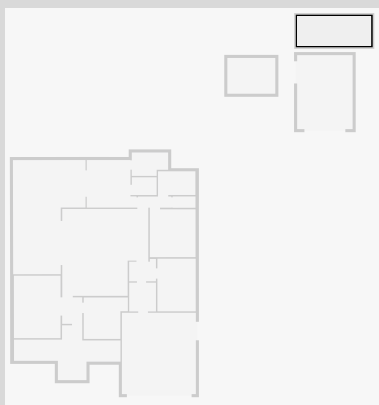

Outdoor Area

Width: 2.90 m
Length: 3.89 m
Area: 11.28 m²
Perimeter: 13.58 m

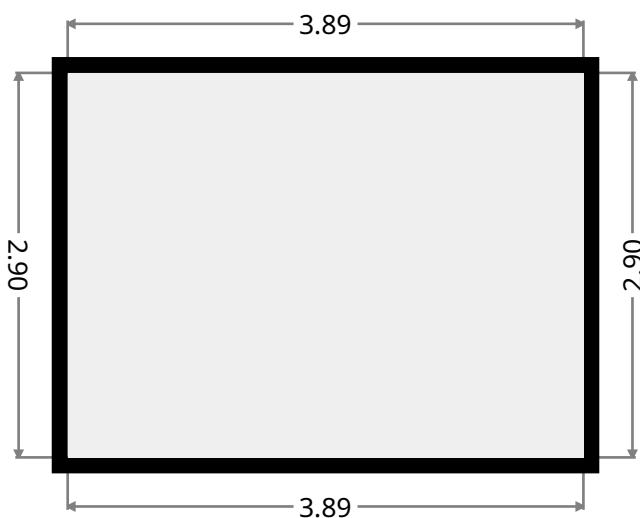
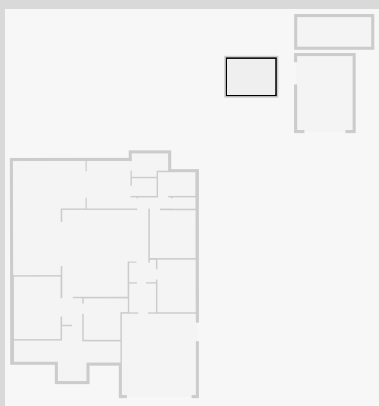

11 Brady Place

Shed

Width: 4.50 m
 Length: 6.00 m
 Area: 27.00 m²
 Perimeter: 21.00 m

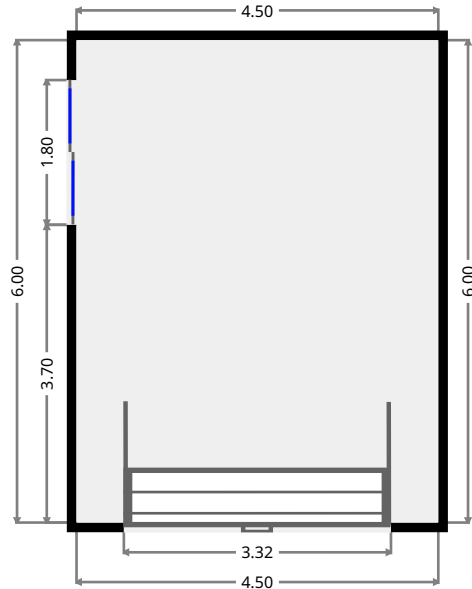
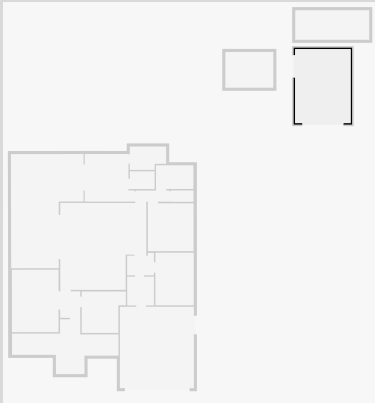

Other

Width: 5.89 m
 Length: 9.27 m
 Area: 43.57 m²
 Perimeter: 30.29 m

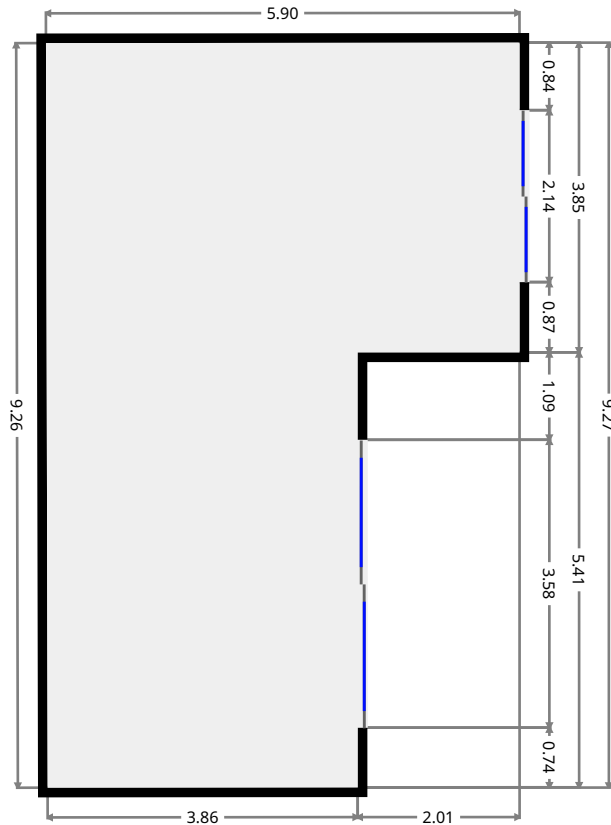
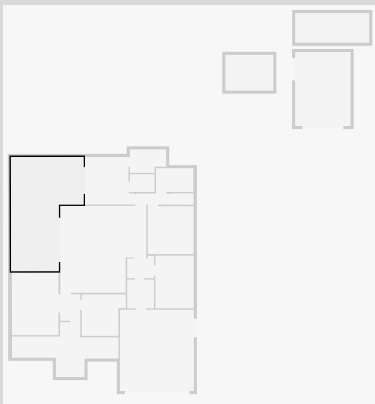

THIS FLOORPLAN IS PROVIDED WITHOUT WARRANTY OF ANY KIND. SENSOPIA DISCLAIMS ANY WARRANTY INCLUDING, WITHOUT LIMITATION, SATISFACTORY QUALITY OR ACCURACY OF DIMENSIONS.

11 Brady Place

Bathroom

Width: 1.90 m
 Length: 2.95 m
 Area: 5.14 m²
 Perimeter: 9.70 m

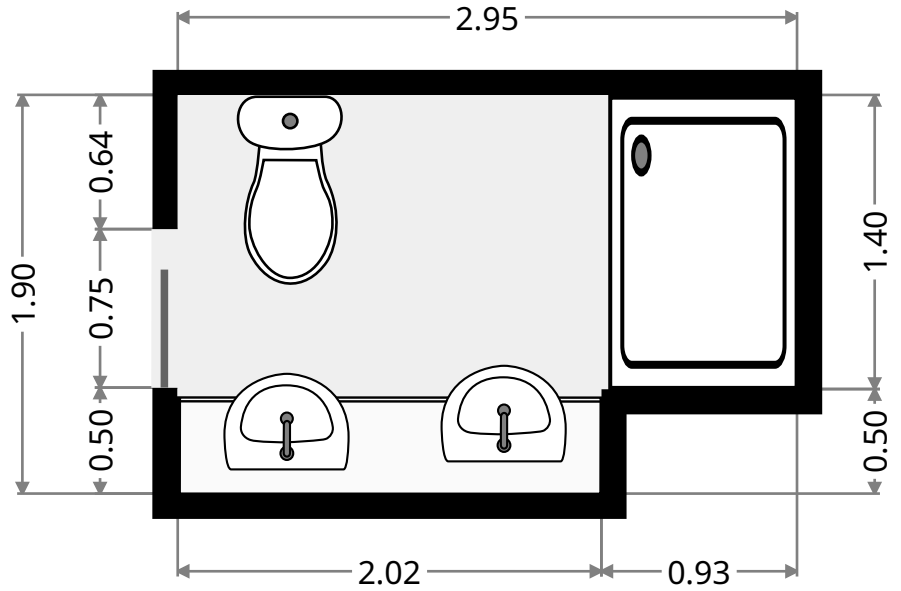
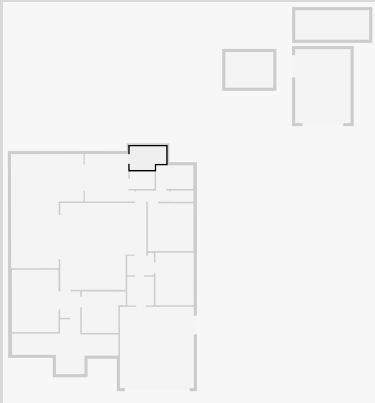

WIR

Width: 1.44 m
 Length: 2.01 m
 Area: 2.89 m²
 Perimeter: 6.90 m

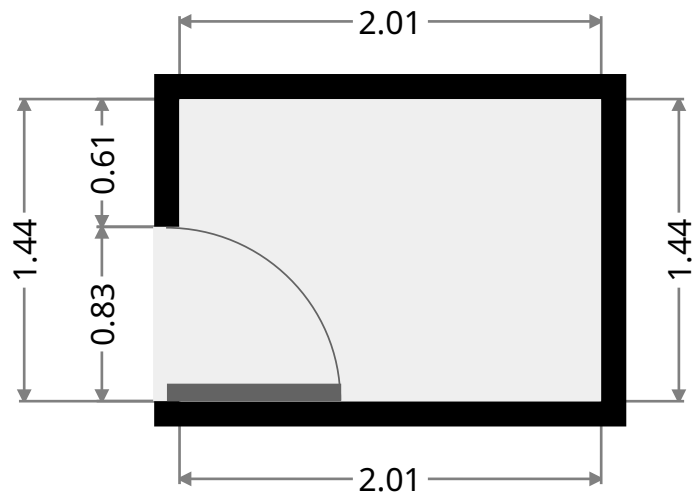
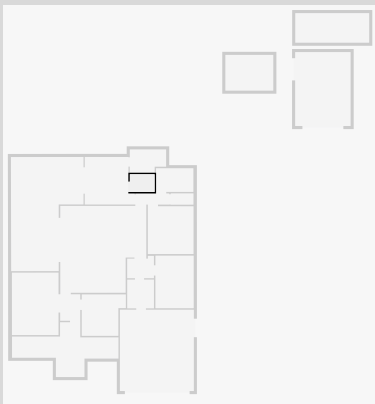

11 Brady Place

Master Bedroom

Width: 3.86 m
 Length: 4.04 m
 Area: 14.12 m²
 Perimeter: 15.79 m

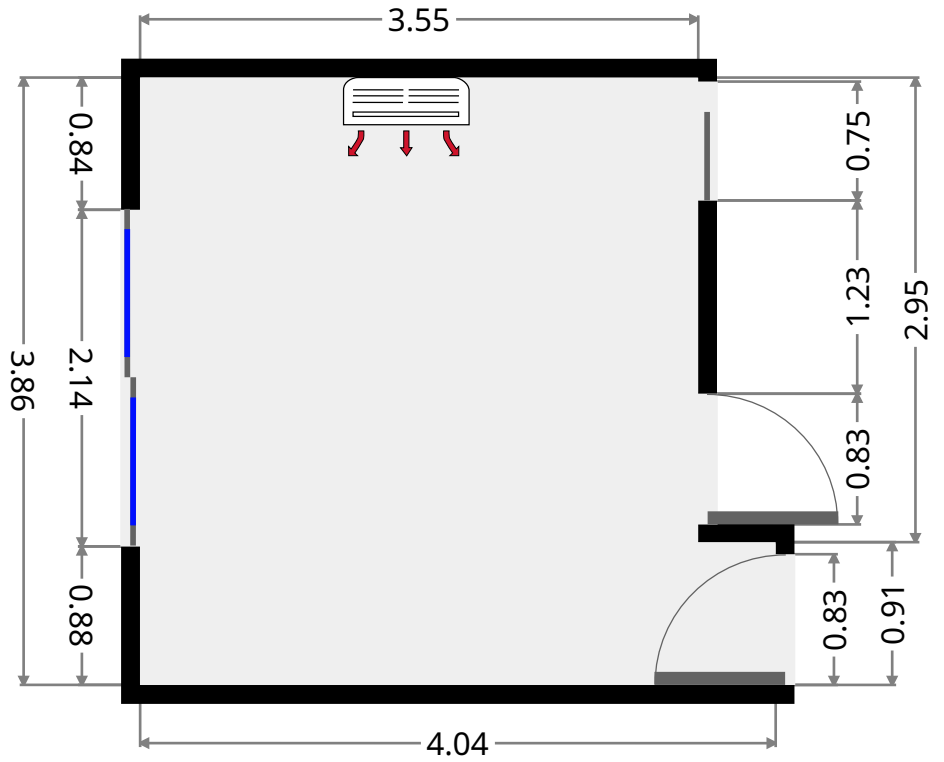
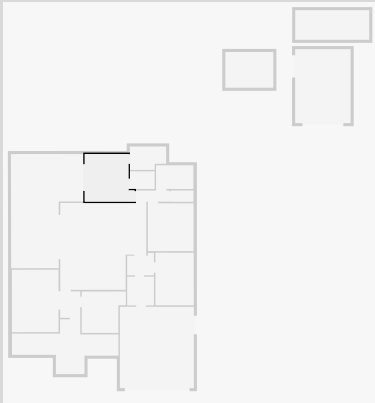

Bathroom

Width: 1.92 m
 Length: 3.03 m
 Area: 5.82 m²
 Perimeter: 9.90 m

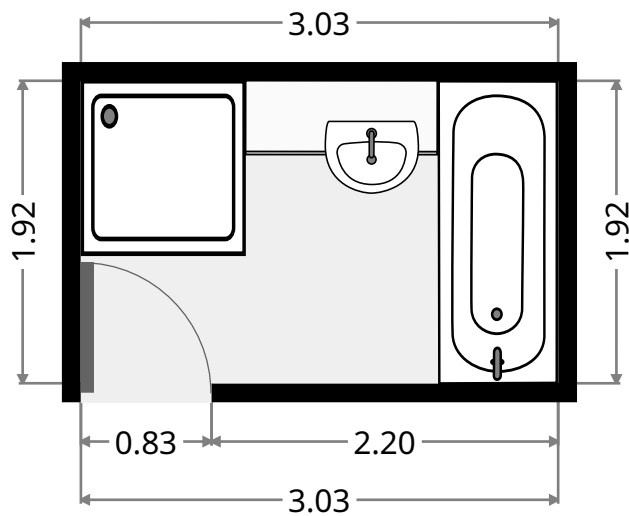
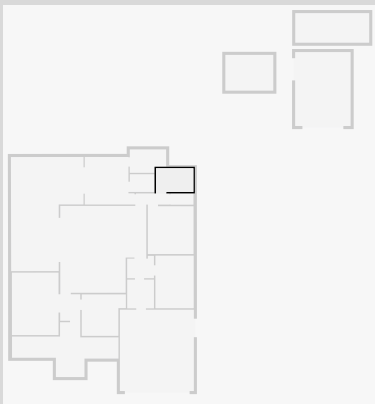

11 Brady Place

Hall

Width: 1.63 m
 Length: 2.15 m
 Area: 3.50 m²
 Perimeter: 7.56 m

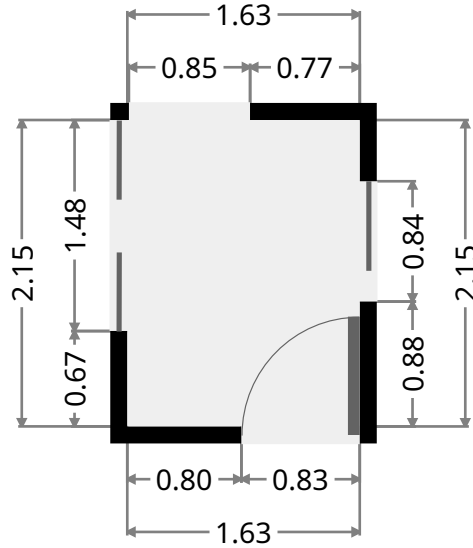
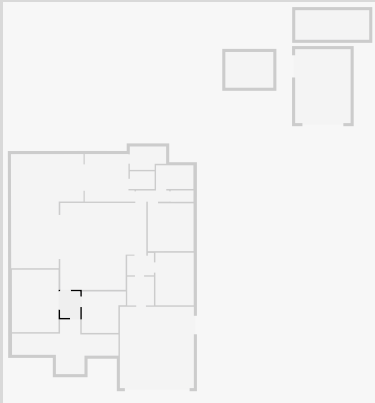

Bedroom

Width: 3.71 m
 Length: 3.88 m
 Area: 14.40 m²
 Perimeter: 15.18 m

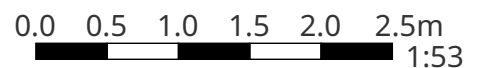
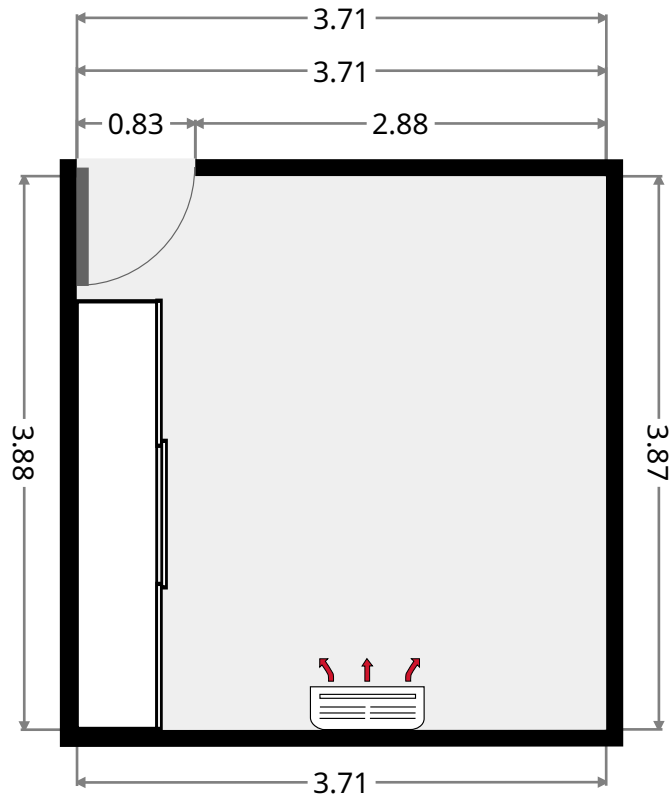
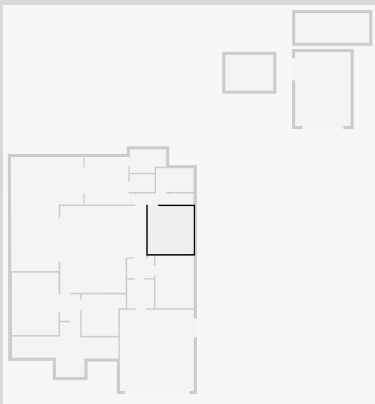

THIS FLOORPLAN IS PROVIDED WITHOUT WARRANTY OF ANY KIND. SENSOPIA DISCLAIMS ANY WARRANTY INCLUDING, WITHOUT LIMITATION, SATISFACTORY QUALITY OR ACCURACY OF DIMENSIONS.

11 Brady Place

Hall

Width: 0.90 m
 Length: 2.70 m
 Area: 2.43 m²
 Perimeter: 7.20 m

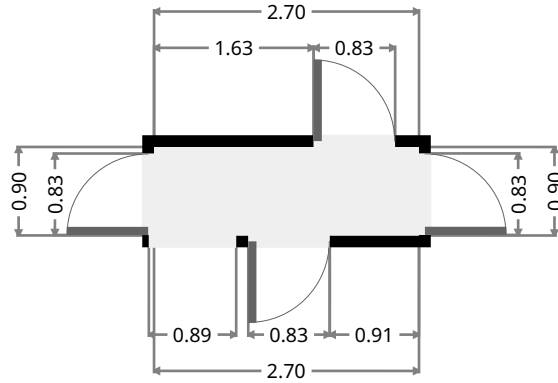
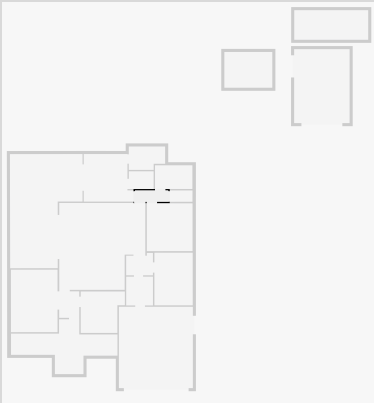

Garage

Width: 6.00 m
 Length: 6.60 m
 Area: 39.60 m²
 Perimeter: 25.20 m

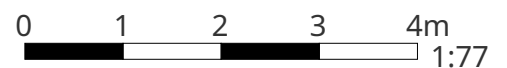
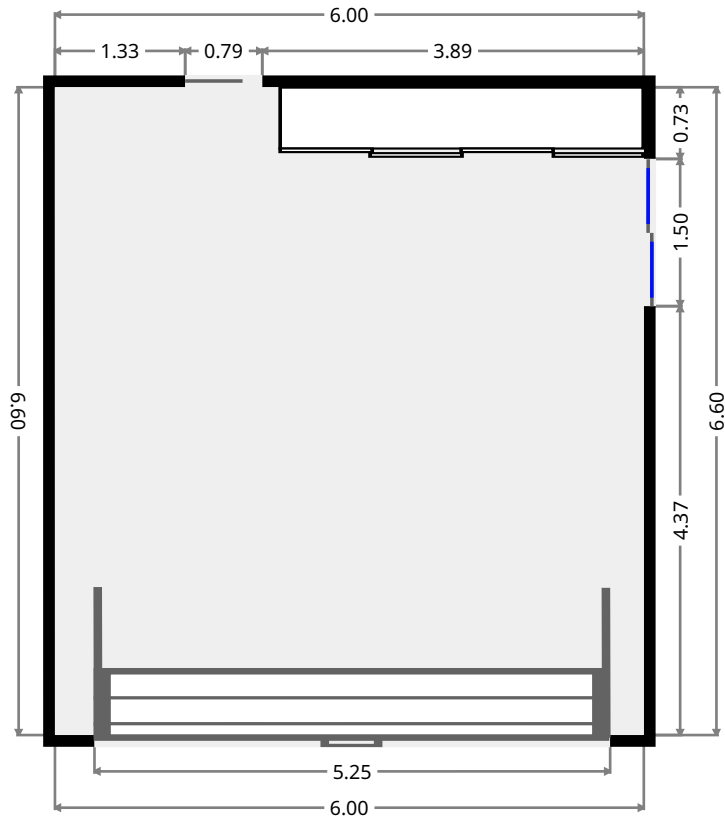
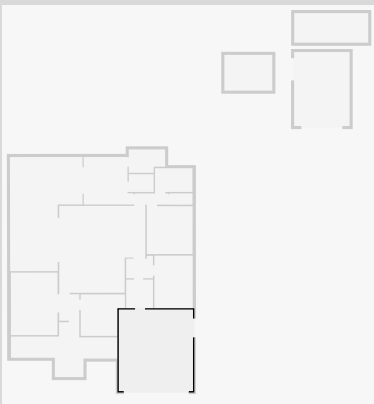

THIS FLOORPLAN IS PROVIDED WITHOUT WARRANTY OF ANY KIND. SENSOPIA DISCLAIMS ANY WARRANTY INCLUDING, WITHOUT LIMITATION, SATISFACTORY QUALITY OR ACCURACY OF DIMENSIONS.

11 Brady Place

Bedroom

Width: 3.11 m
 Length: 4.27 m
 Area: 13.27 m²
 Perimeter: 14.76 m

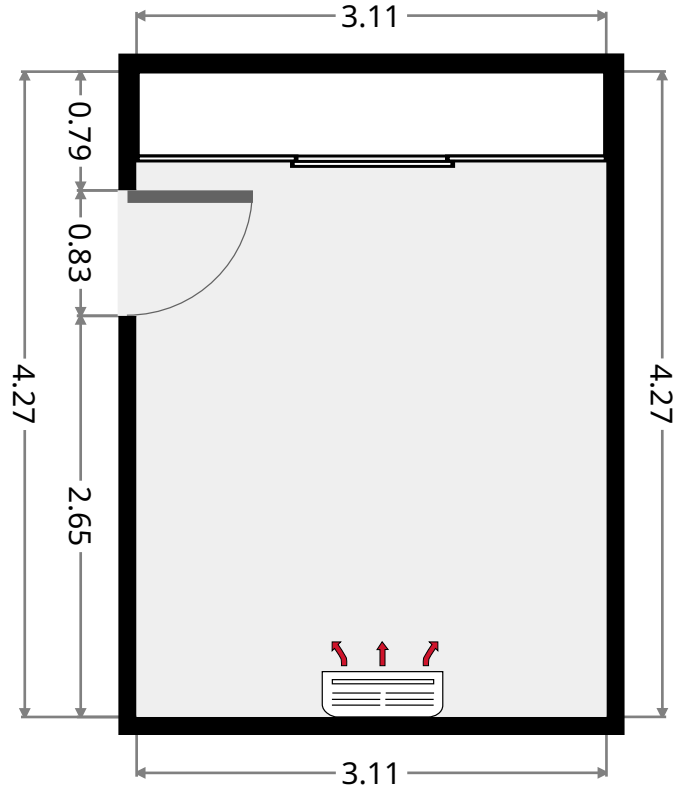
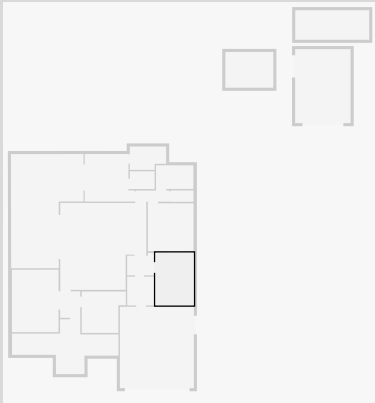

Laundry Room

Width: 2.17 m
 Length: 2.34 m
 Area: 5.07 m²
 Perimeter: 9.01 m

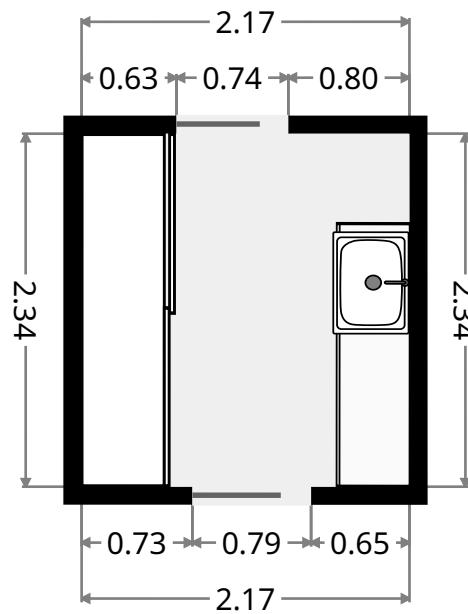
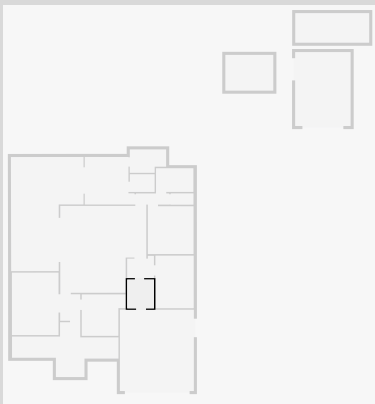

11 Brady Place

Hall

Width: 1.82 m
 Length: 2.17 m
 Area: 3.56 m²
 Perimeter: 7.97 m

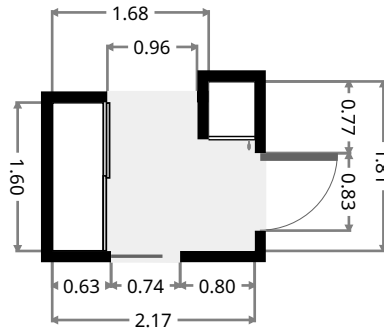
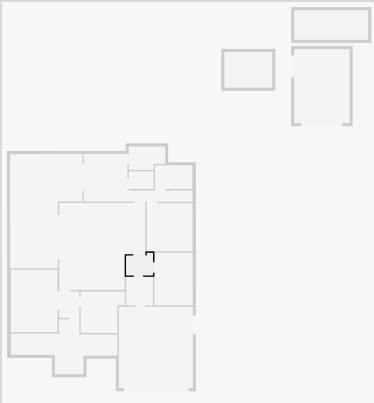

Kitchen/Living/Dining

Width: 6.98 m
 Length: 7.05 m
 Area: 44.42 m²
 Perimeter: 28.06 m

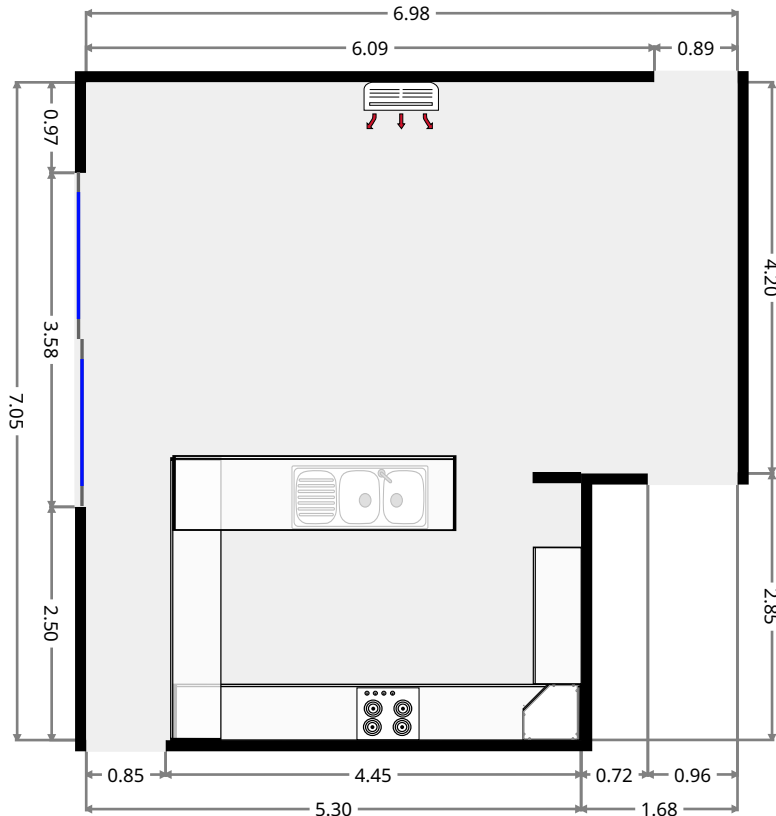
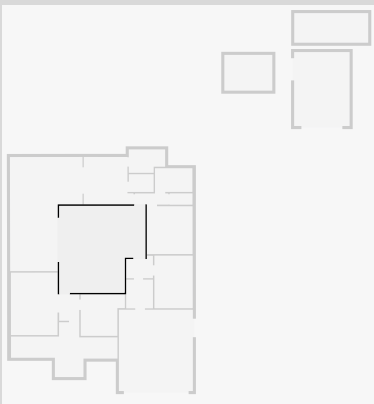

THIS FLOORPLAN IS PROVIDED WITHOUT WARRANTY OF ANY KIND. SENSOPIA DISCLAIMS ANY WARRANTY INCLUDING, WITHOUT LIMITATION, SATISFACTORY QUALITY OR ACCURACY OF DIMENSIONS.

11 Brady Place

Bedroom

Width: 3.36 m
 Length: 3.58 m
 Area: 10.67 m²
 Perimeter: 13.88 m

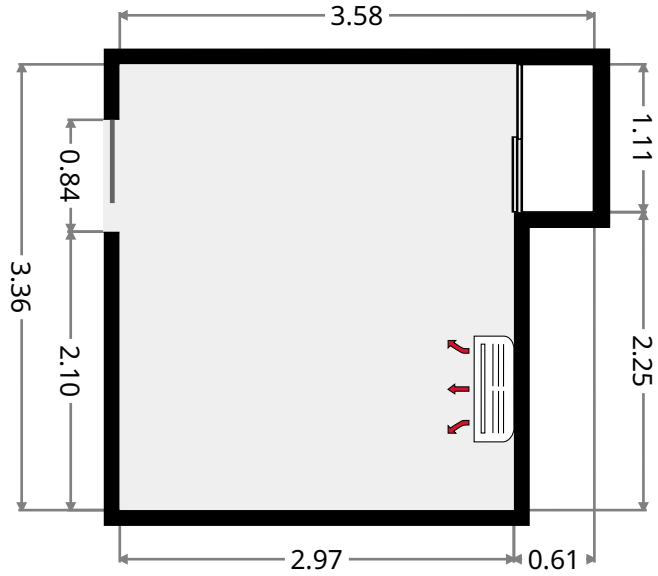
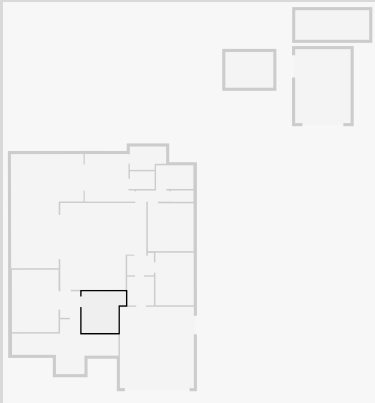

Media Room

Width: 3.79 m
 Length: 5.07 m
 Area: 19.18 m²
 Perimeter: 17.70 m

