

108 Dean Street

Ground Floor

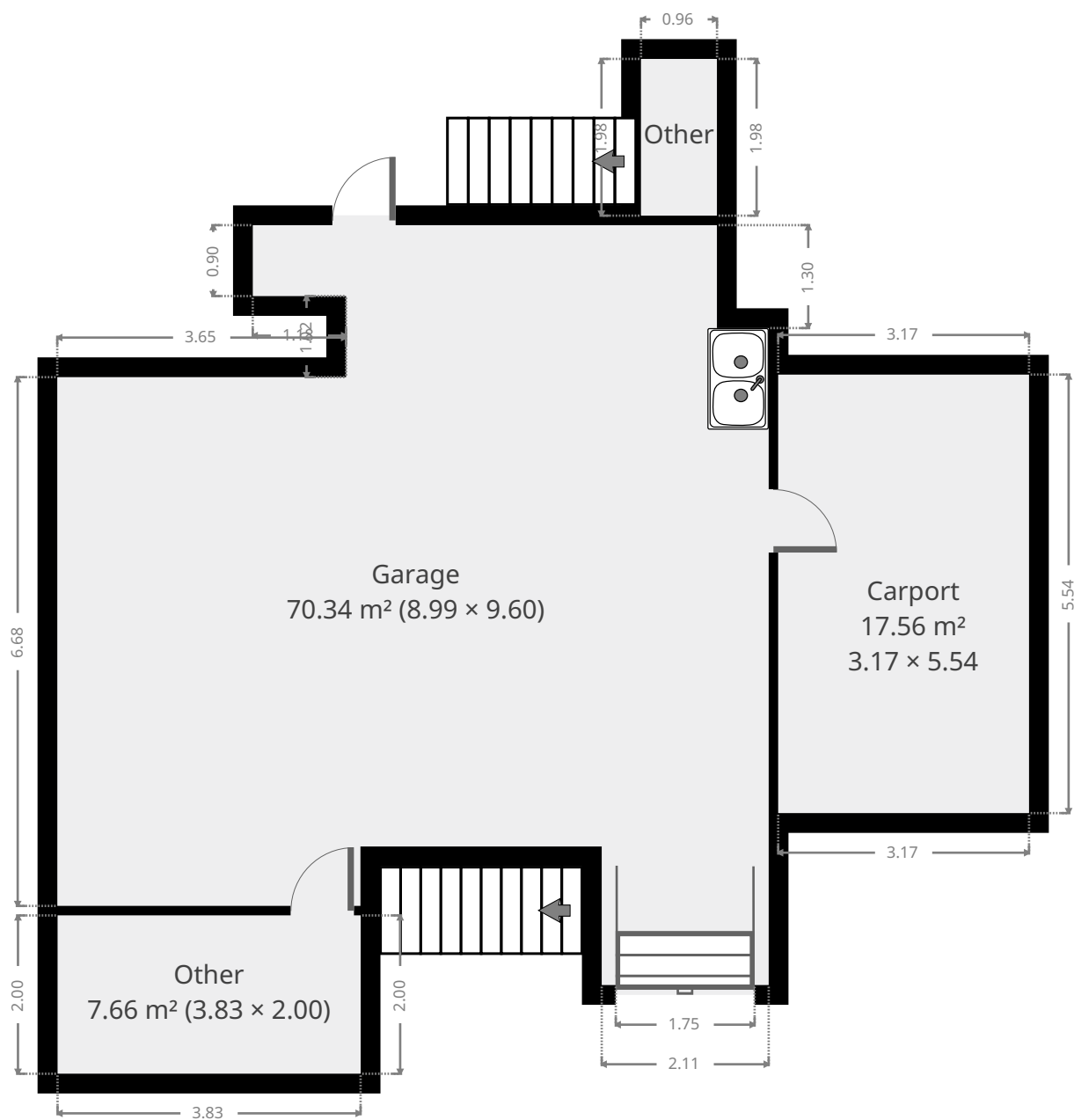

THIS FLOORPLAN IS PROVIDED WITHOUT WARRANTY OF ANY KIND. SENSOPIA DISCLAIMS ANY WARRANTY INCLUDING, WITHOUT LIMITATION, SATISFACTORY QUALITY OR ACCURACY OF DIMENSIONS.

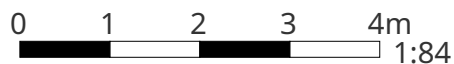

108 Dean Street

Garage

Width: 8.99 m
 Length: 9.60 m
 Area: 70.34 m²
 Perimeter: 41.04 m

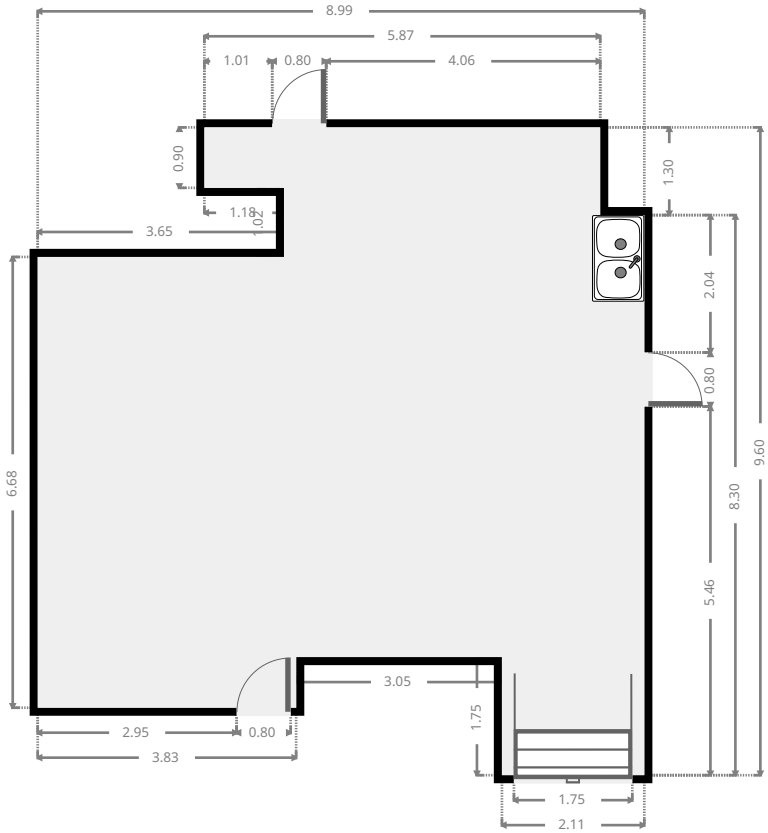
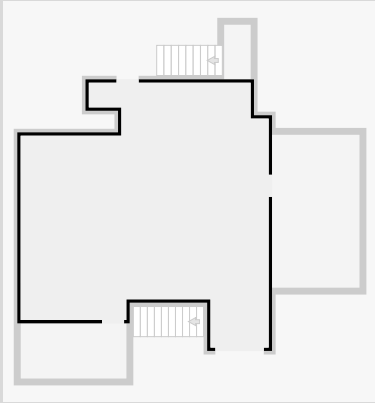

Carport

Width: 3.17 m
 Length: 5.54 m
 Area: 17.56 m²
 Perimeter: 17.42 m

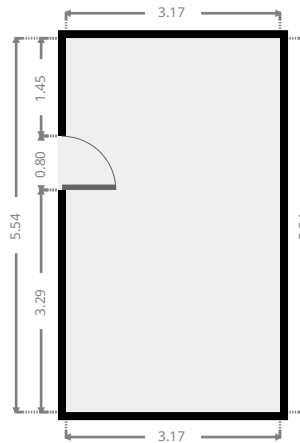
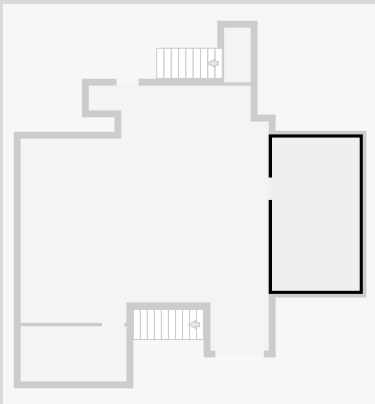

108 Dean Street

Other

Width: 0.96 m
 Length: 1.98 m
 Area: 1.90 m²
 Perimeter: 5.88 m

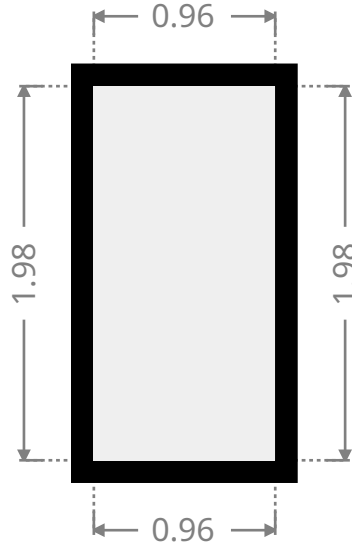
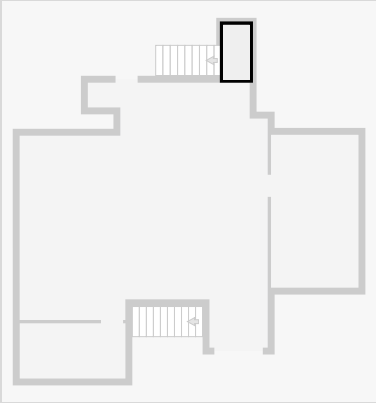

Other

Width: 2.00 m
 Length: 3.83 m
 Area: 7.66 m²
 Perimeter: 11.66 m

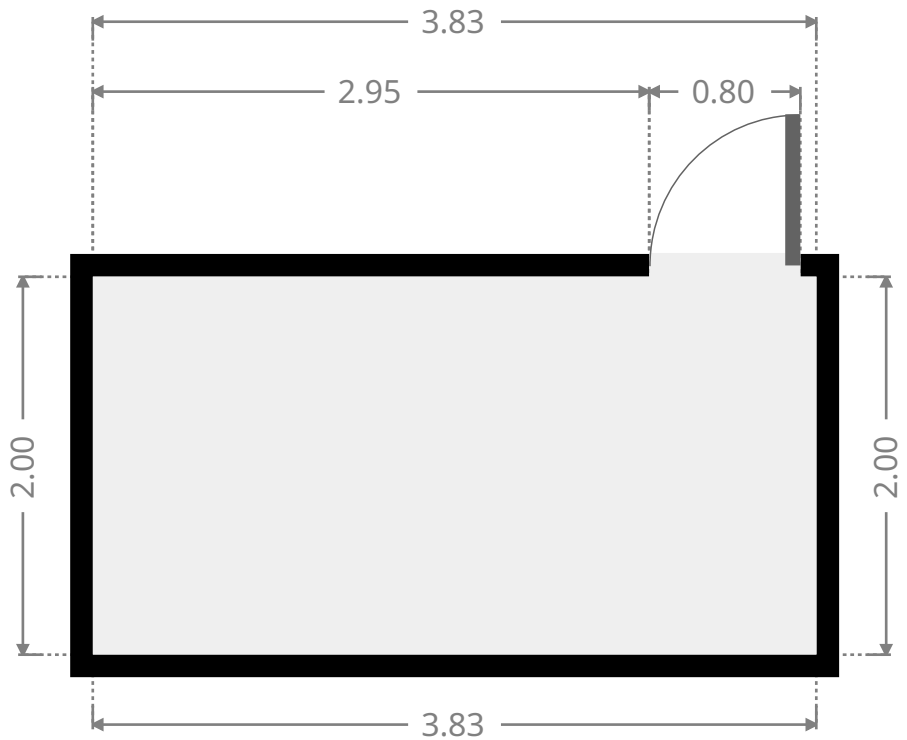
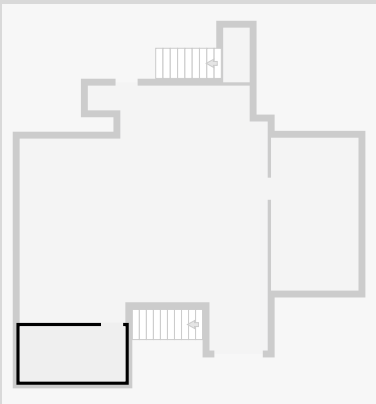

THIS FLOORPLAN IS PROVIDED WITHOUT WARRANTY OF ANY KIND. SENSOPIA DISCLAIMS ANY WARRANTY INCLUDING, WITHOUT LIMITATION, SATISFACTORY QUALITY OR ACCURACY OF DIMENSIONS.

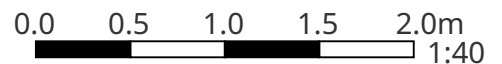

108 Dean Street

1st Floor

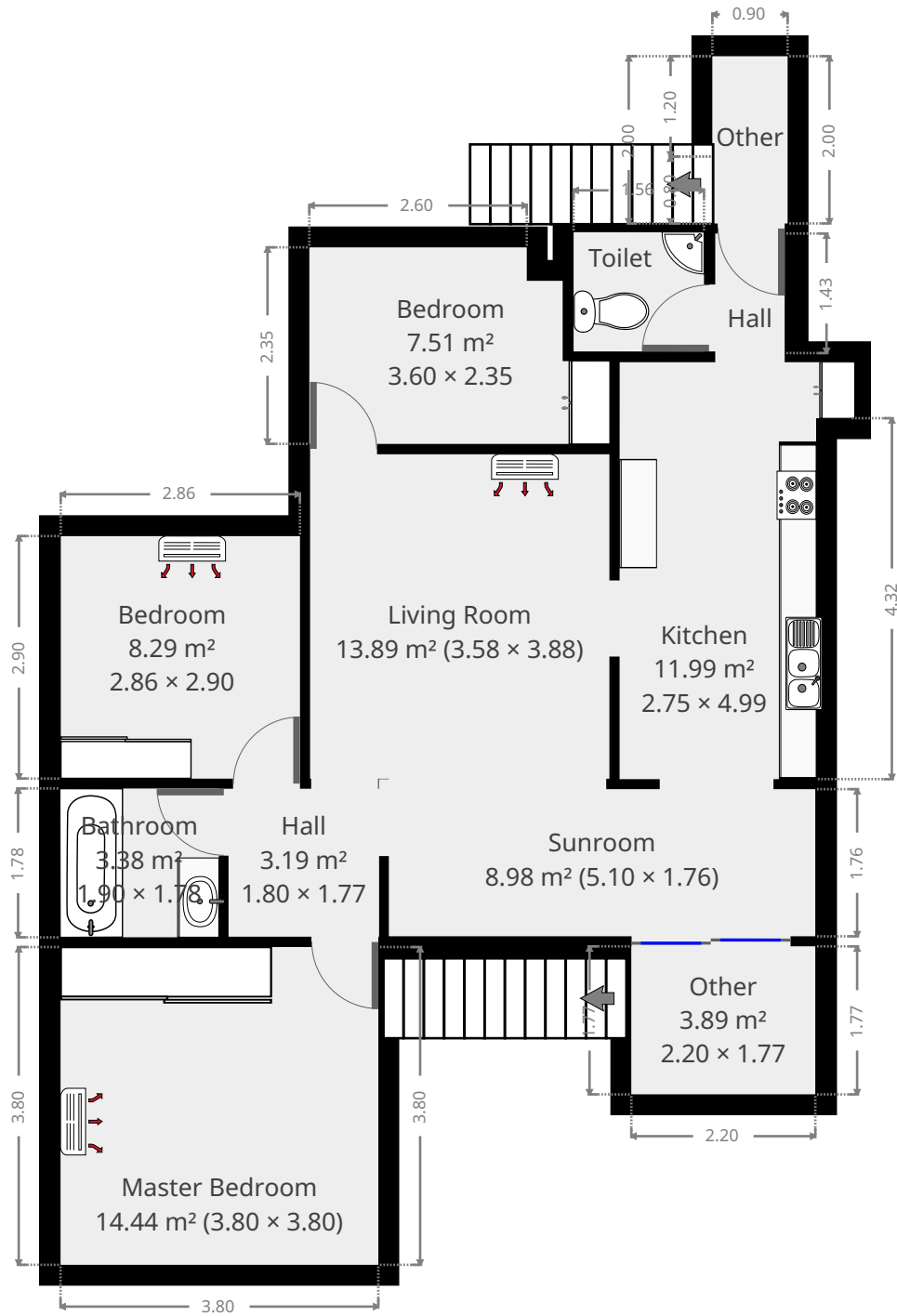

THIS FLOORPLAN IS PROVIDED WITHOUT WARRANTY OF ANY KIND. SENSOPIA DISCLAIMS ANY WARRANTY INCLUDING, WITHOUT LIMITATION, SATISFACTORY QUALITY OR ACCURACY OF DIMENSIONS.



108 Dean Street

Sunroom

Width: 1.76 m
 Length: 5.10 m
 Area: 8.98 m²
 Perimeter: 13.72 m

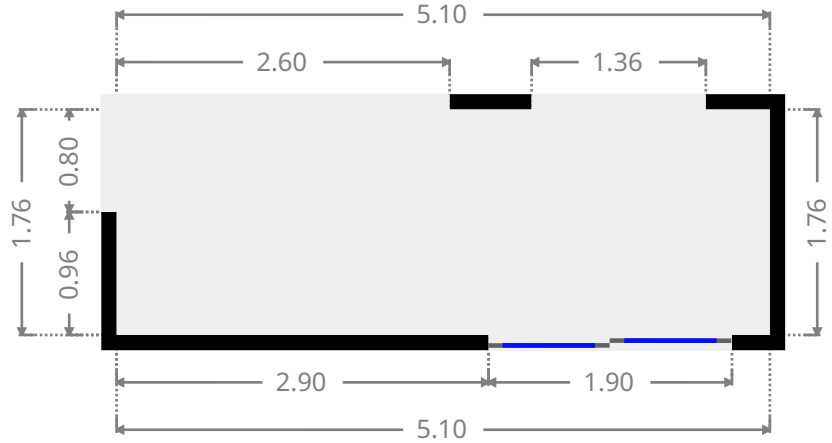
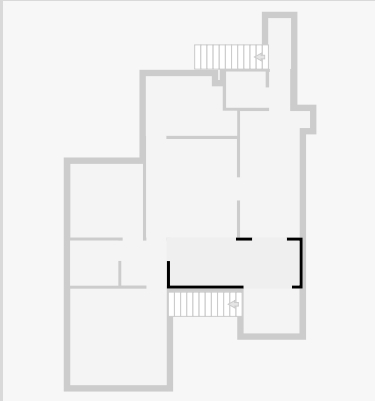

Living Room

Width: 3.58 m
 Length: 3.88 m
 Area: 13.89 m²
 Perimeter: 14.92 m

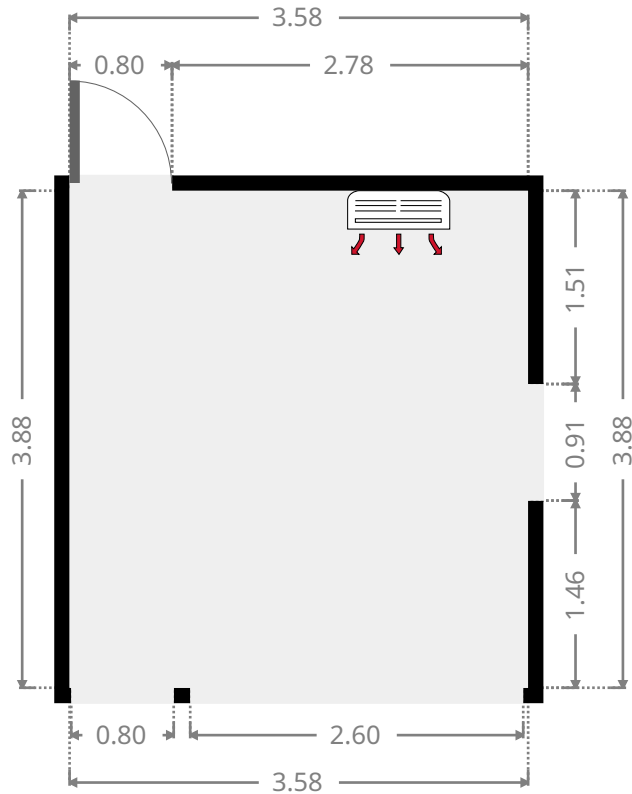
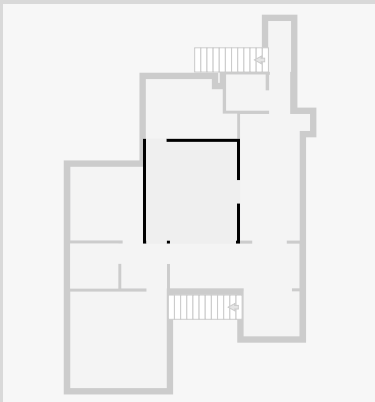

THIS FLOORPLAN IS PROVIDED WITHOUT WARRANTY OF ANY KIND. SENSOPIA DISCLAIMS ANY WARRANTY INCLUDING, WITHOUT LIMITATION, SATISFACTORY QUALITY OR ACCURACY OF DIMENSIONS.

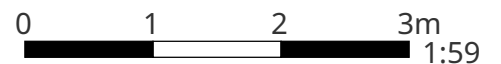

108 Dean Street

Kitchen

Width: 2.75 m
Length: 4.99 m
Area: 11.99 m²
Perimeter: 15.48 m

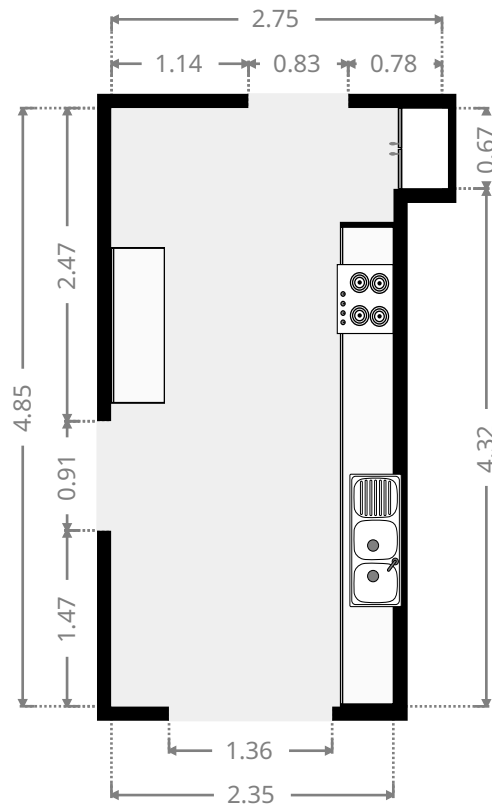
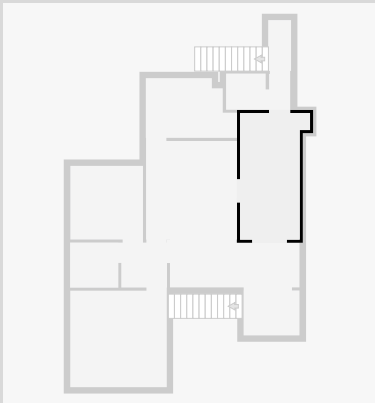

Hall

Width: 0.83 m
Length: 1.43 m
Area: 1.19 m²
Perimeter: 4.52 m

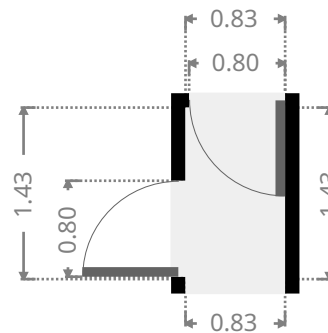
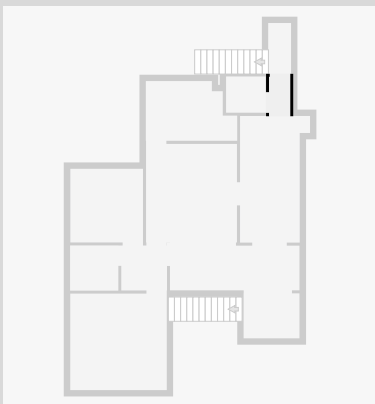

108 Dean Street

Toilet / Half Bath

Width: 1.43 m
Length: 1.56 m
Area: 2.22 m²
Perimeter: 5.97 m

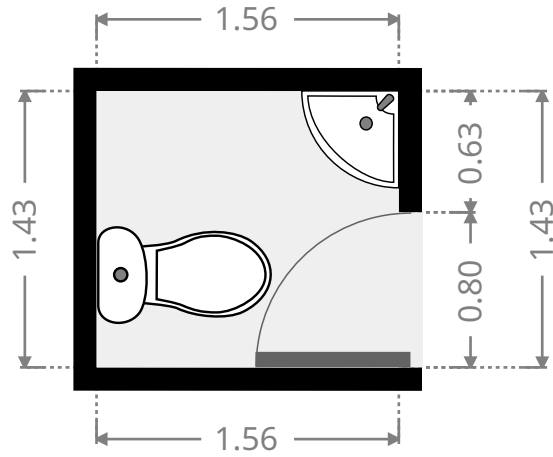
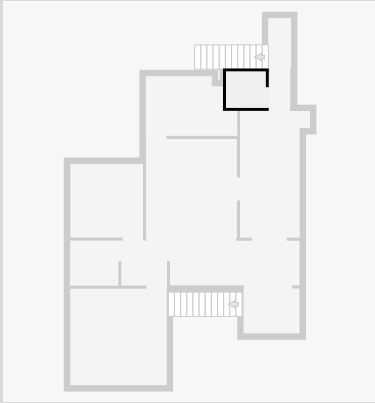

Other

Width: 0.90 m
Length: 2.00 m
Area: 1.80 m²
Perimeter: 5.80 m

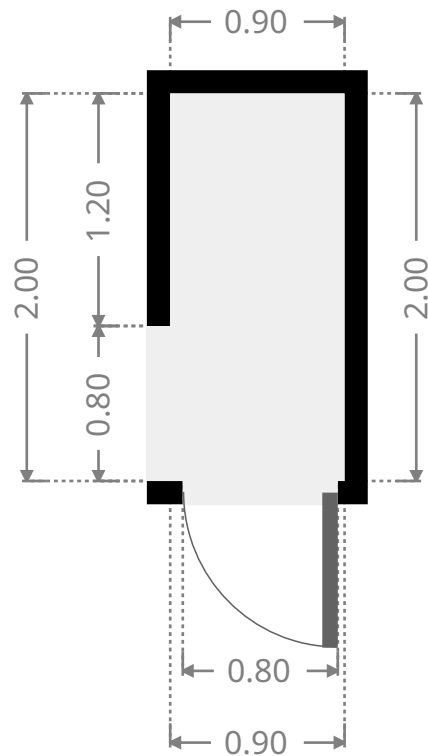
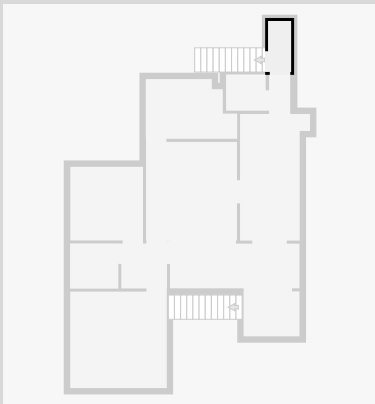

108 Dean Street

Bedroom

Width: 2.35 m
 Length: 3.60 m
 Area: 7.51 m²
 Perimeter: 11.90 m

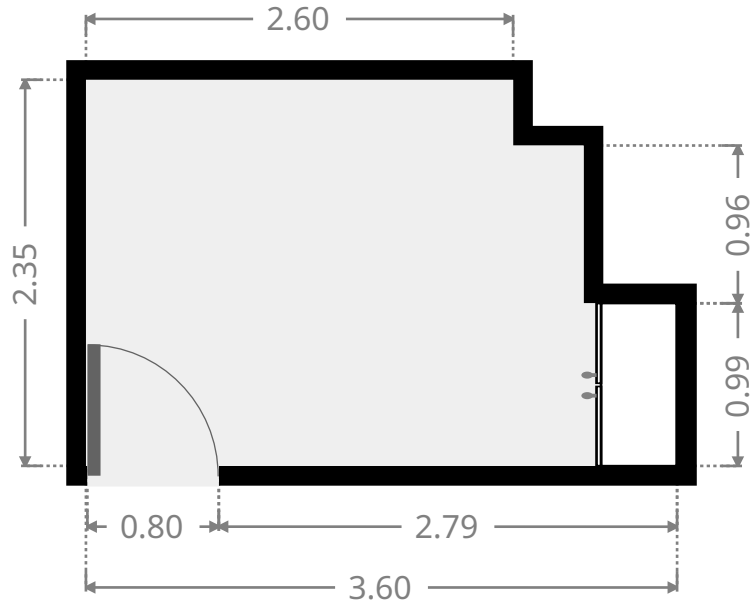
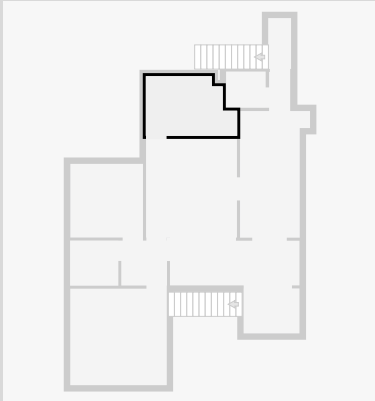

Hall

Width: 1.77 m
 Length: 1.80 m
 Area: 3.19 m²
 Perimeter: 7.14 m

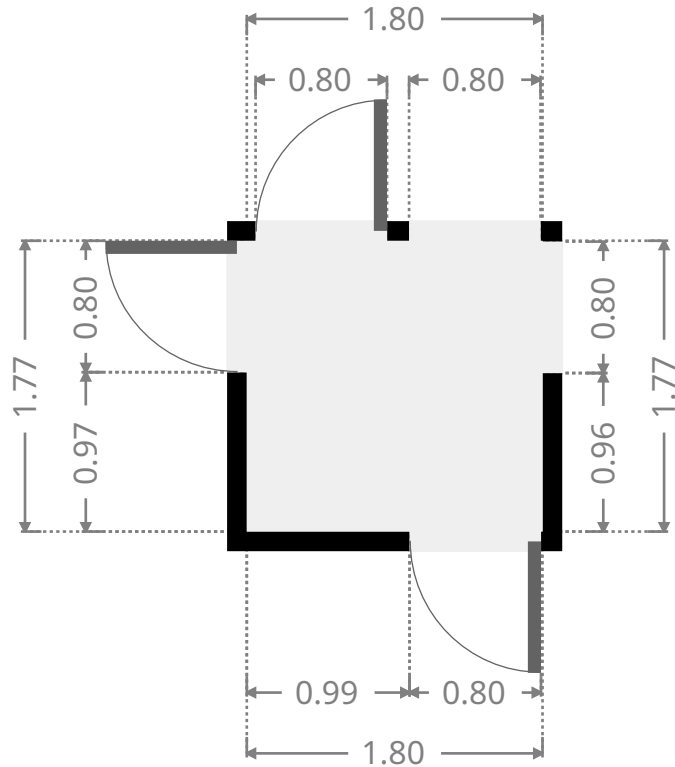
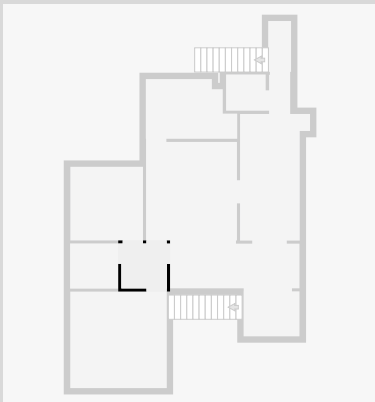

THIS FLOORPLAN IS PROVIDED WITHOUT WARRANTY OF ANY KIND. SENSOPIA DISCLAIMS ANY WARRANTY INCLUDING, WITHOUT LIMITATION, SATISFACTORY QUALITY OR ACCURACY OF DIMENSIONS.

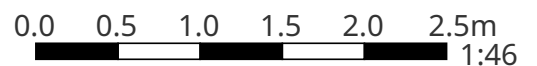

108 Dean Street

Bedroom

Width: 2.86 m
Length: 2.90 m
Area: 8.29 m²
Perimeter: 11.52 m

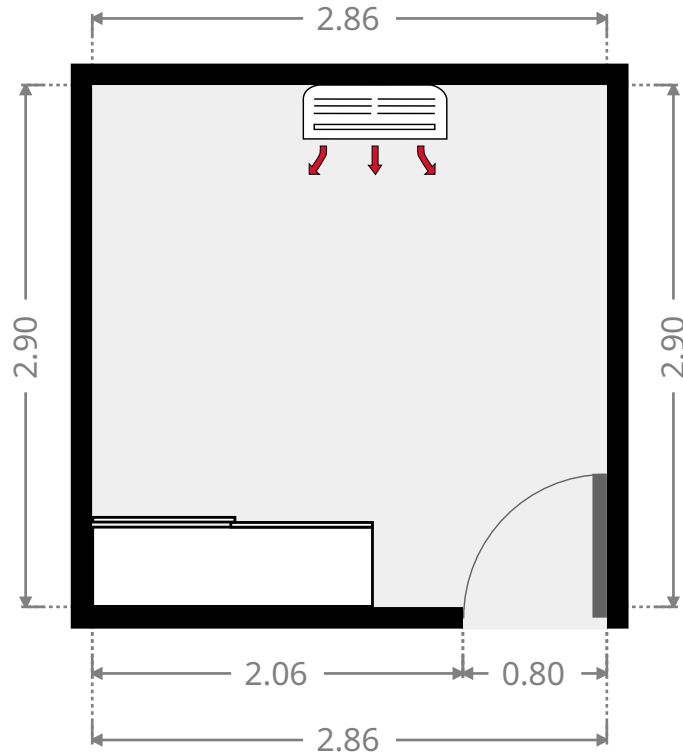
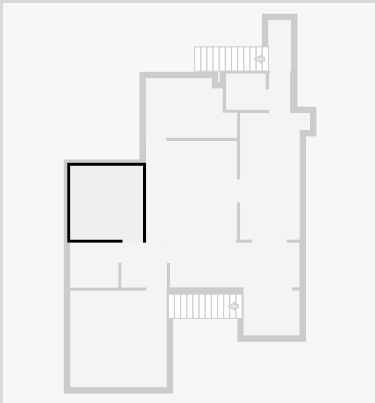

Bathroom

Width: 1.78 m
Length: 1.90 m
Area: 3.38 m²
Perimeter: 7.36 m

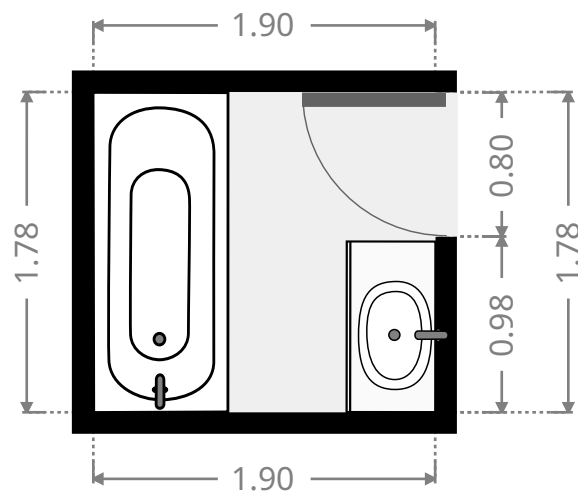
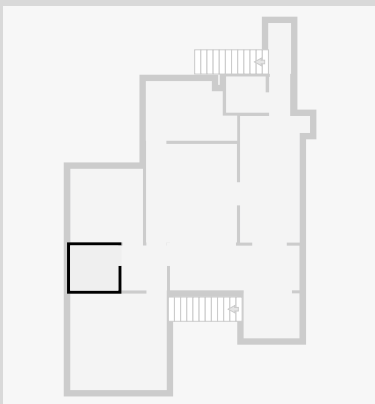

108 Dean Street

Master Bedroom

Width: 3.80 m
Length: 3.80 m
Area: 14.44 m²
Perimeter: 15.20 m

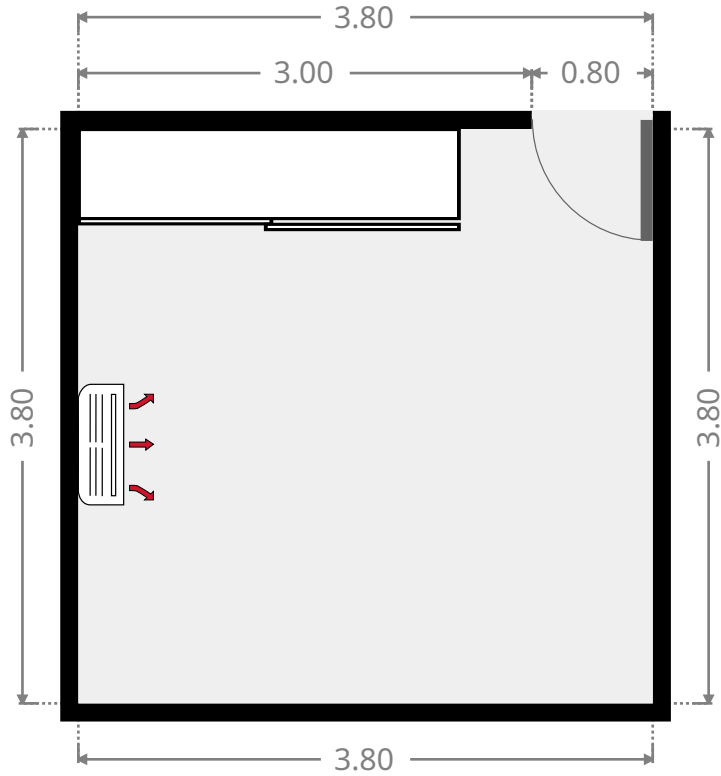
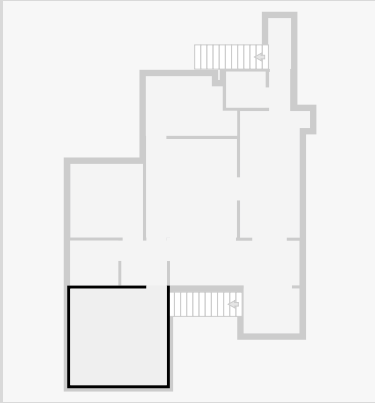

Other

Width: 1.77 m
Length: 2.20 m
Area: 3.89 m²
Perimeter: 7.94 m

