

# Ground Floor

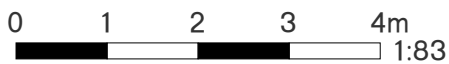
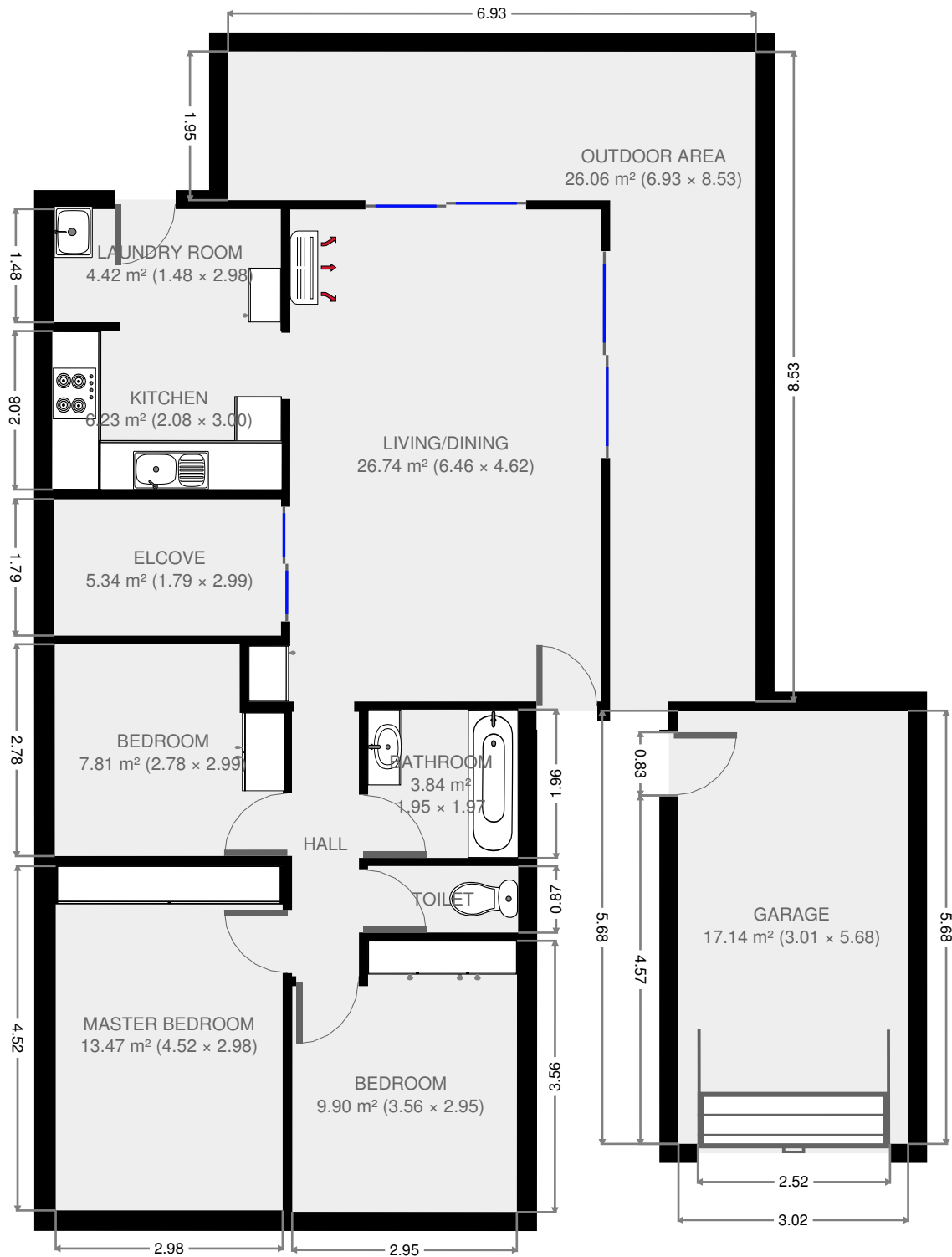

THIS FLOORPLAN IS PROVIDED WITHOUT WARRANTY OF ANY KIND. SENSOPIA DISCLAIMS ANY WARRANTY INCLUDING, WITHOUT LIMITATION, SATISFACTORY QUALITY OR ACCURACY OF DIMENSIONS.

## 107 Burnett Street

# Living/Dining

Width: 4.62 m  
 Length: 6.46 m  
 Area: 26.74 m<sup>2</sup>  
 Perimeter: 22.16 m

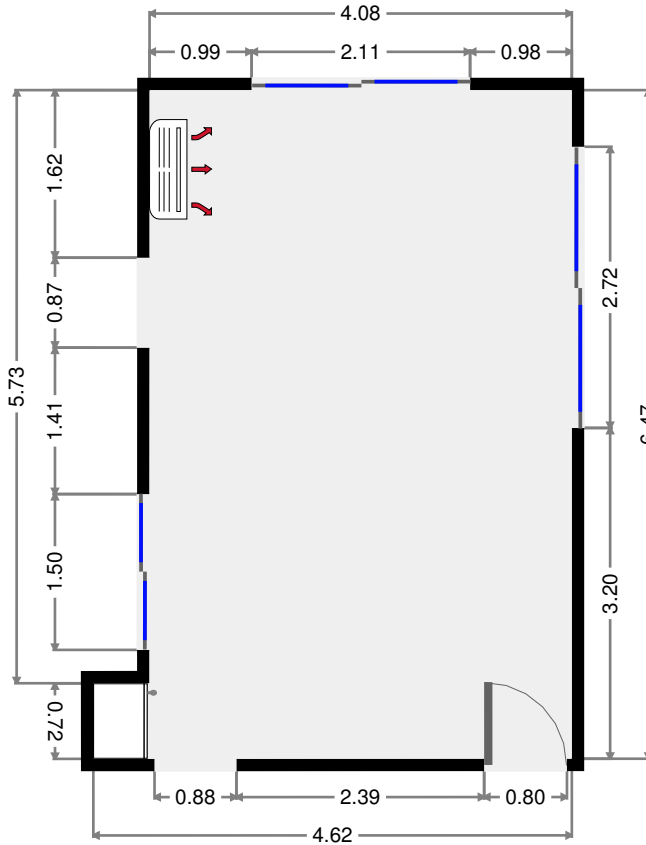
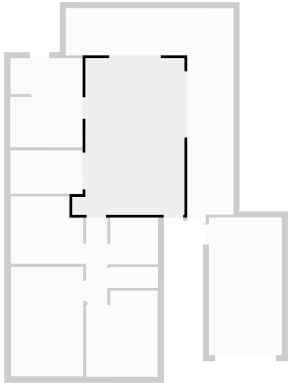

# Kitchen

Width: 2.08 m  
 Length: 3.00 m  
 Area: 6.23 m<sup>2</sup>  
 Perimeter: 10.15 m

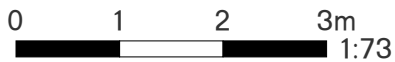
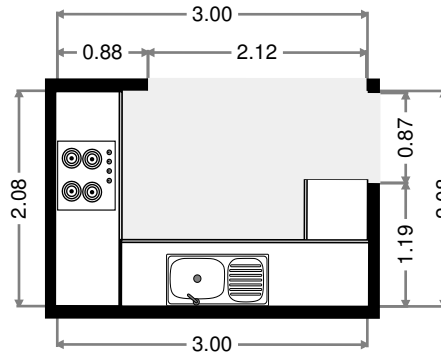
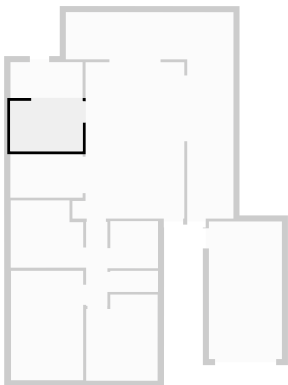

THIS FLOORPLAN IS PROVIDED WITHOUT WARRANTY OF ANY KIND. SENSOPIA DISCLAIMS ANY WARRANTY INCLUDING, WITHOUT LIMITATION, SATISFACTORY QUALITY OR ACCURACY OF DIMENSIONS.

# Laundry Room

Width: 1.48 m  
 Length: 2.98 m  
 Area: 4.42 m<sup>2</sup>  
 Perimeter: 8.92 m

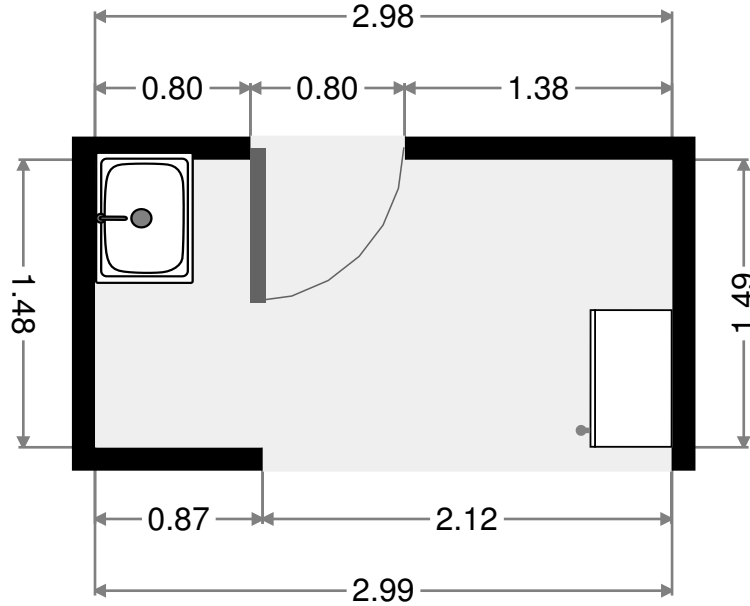
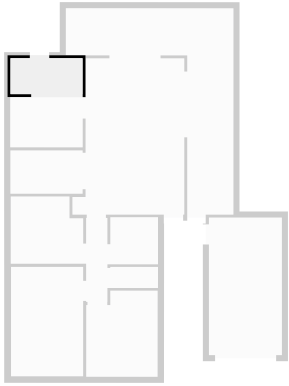

# Elcove

Width: 1.79 m  
 Length: 2.99 m  
 Area: 5.34 m<sup>2</sup>  
 Perimeter: 9.55 m

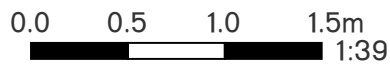
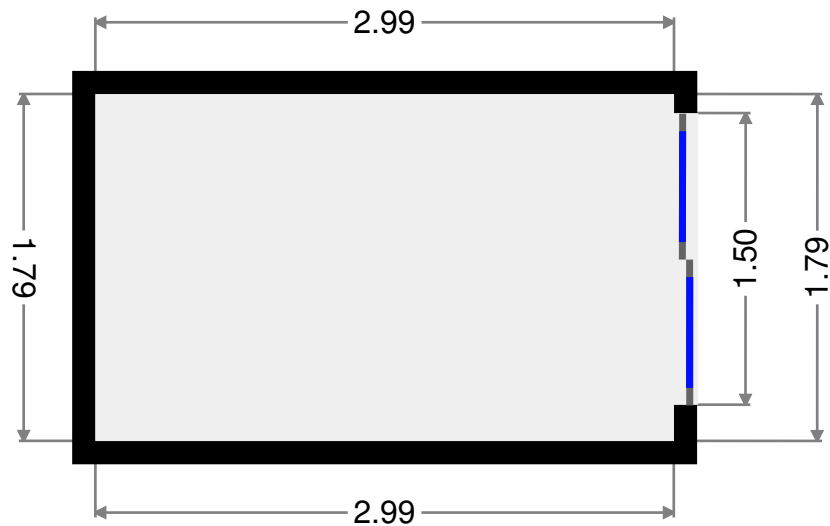
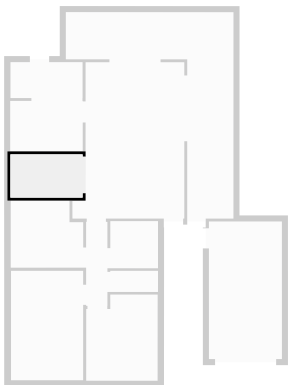

THIS FLOORPLAN IS PROVIDED WITHOUT WARRANTY OF ANY KIND. SENSOPIA DISCLAIMS ANY WARRANTY INCLUDING, WITHOUT LIMITATION, SATISFACTORY QUALITY OR ACCURACY OF DIMENSIONS.

# Hall

Width: 0.88 m  
 Length: 3.47 m  
 Area: 3.05 m<sup>2</sup>  
 Perimeter: 8.70 m

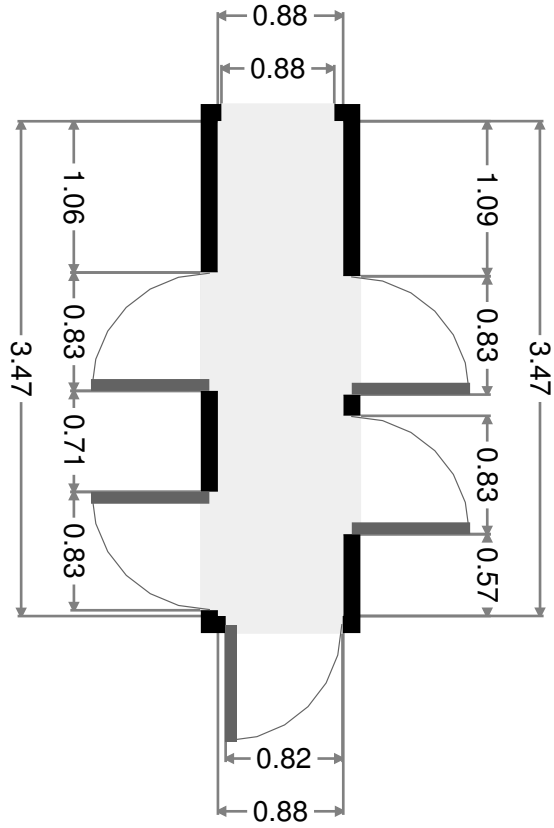

# Bedroom

Width: 2.78 m  
 Length: 2.99 m  
 Area: 7.81 m<sup>2</sup>  
 Perimeter: 11.55 m

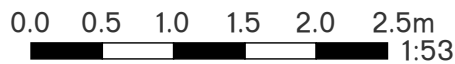
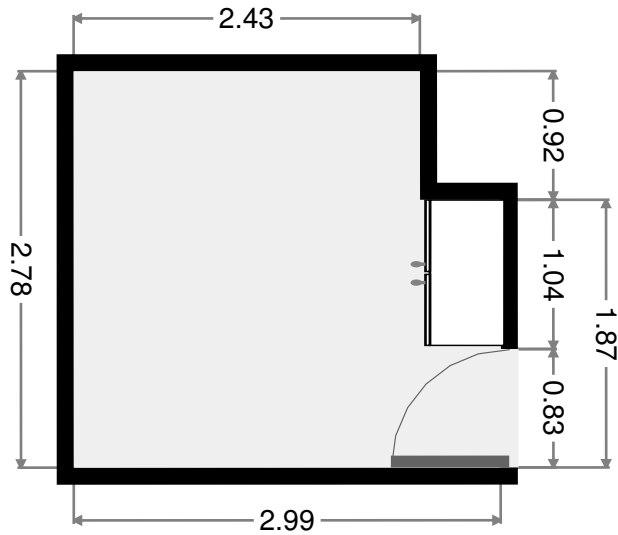
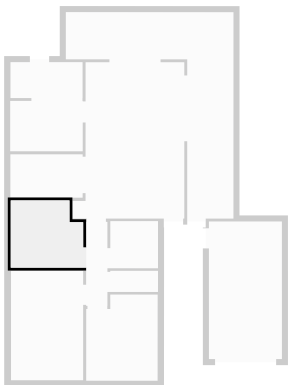

THIS FLOORPLAN IS PROVIDED WITHOUT WARRANTY OF ANY KIND. SENSOPIA DISCLAIMS ANY WARRANTY INCLUDING, WITHOUT LIMITATION, SATISFACTORY QUALITY OR ACCURACY OF DIMENSIONS.

# Master Bedroom

Width: 2.98 m  
 Length: 4.52 m  
 Area: 13.47 m<sup>2</sup>  
 Perimeter: 15.00 m

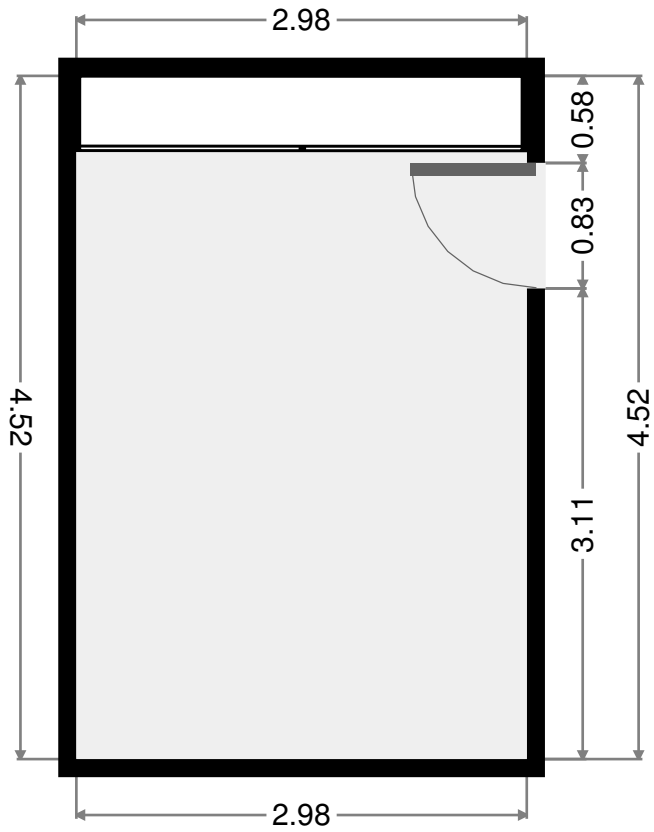
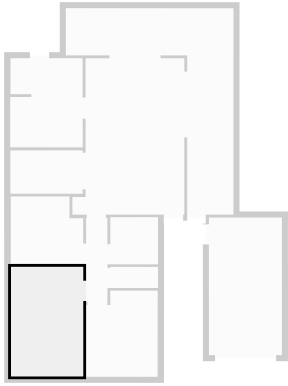

# Bedroom

Width: 2.95 m  
 Length: 3.56 m  
 Area: 9.90 m<sup>2</sup>  
 Perimeter: 13.02 m

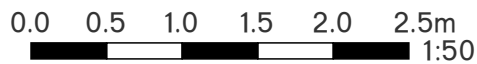
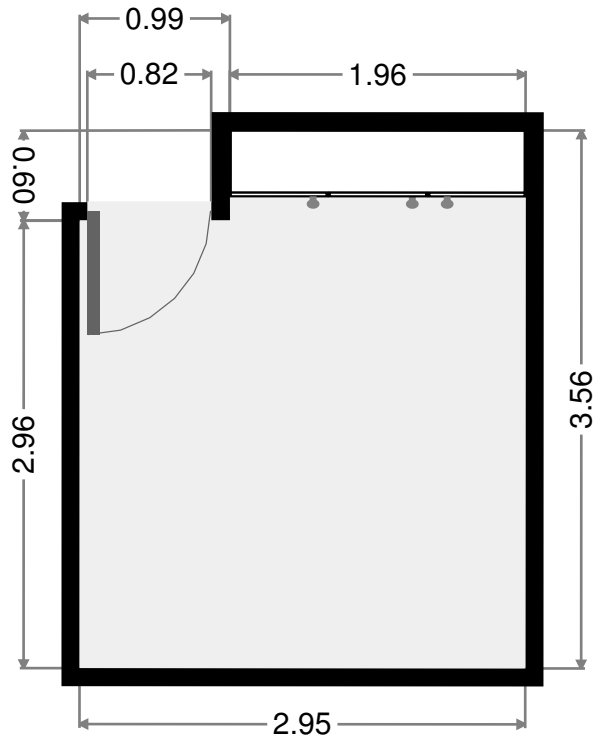
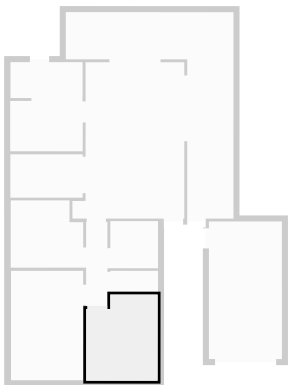

THIS FLOORPLAN IS PROVIDED WITHOUT WARRANTY OF ANY KIND. SENSOPIA DISCLAIMS ANY WARRANTY INCLUDING, WITHOUT LIMITATION, SATISFACTORY QUALITY OR ACCURACY OF DIMENSIONS.

# Toilet

Width: 0.87 m  
 Length: 1.98 m  
 Area: 1.72 m<sup>2</sup>  
 Perimeter: 5.69 m

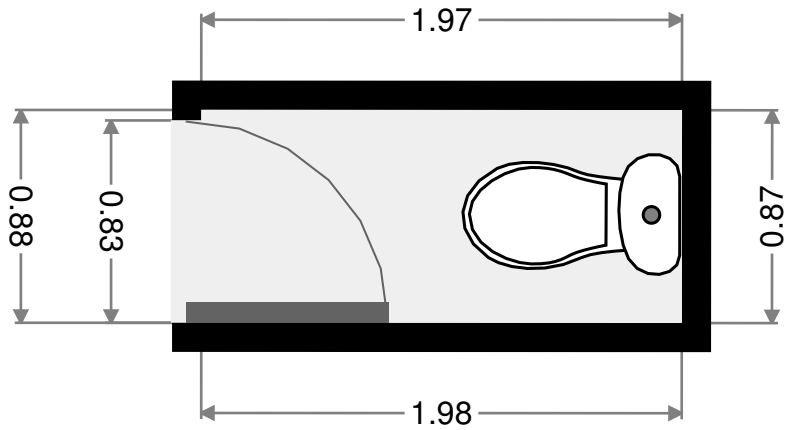
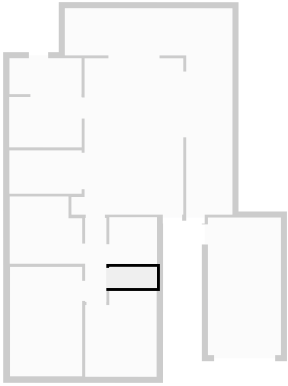

# Bathroom

Width: 1.95 m  
 Length: 1.97 m  
 Area: 3.84 m<sup>2</sup>  
 Perimeter: 7.83 m

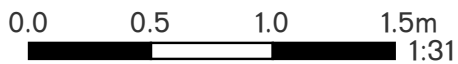
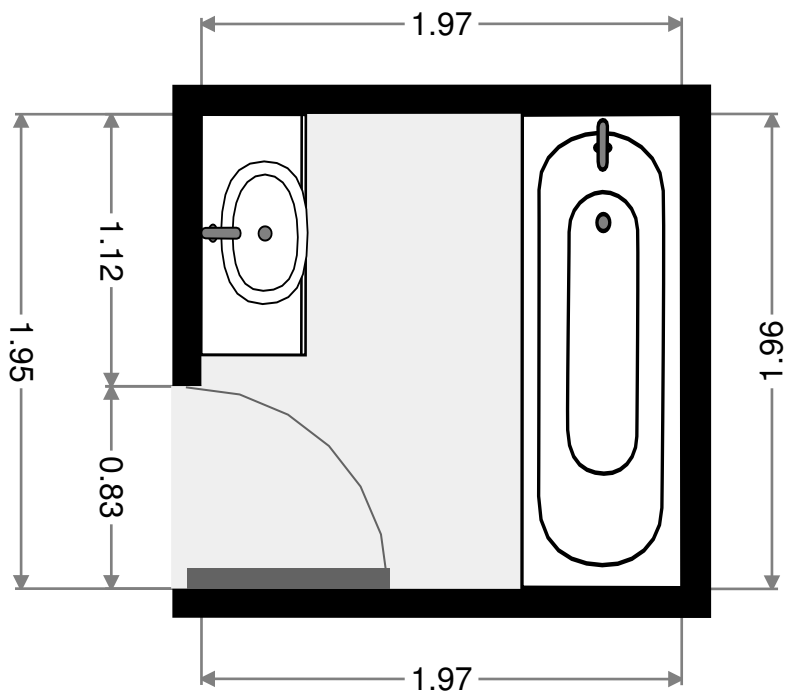
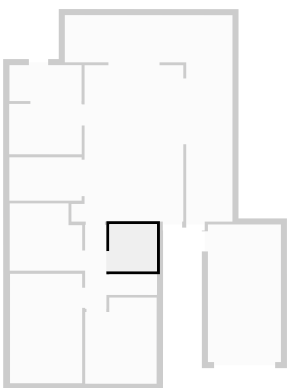

THIS FLOORPLAN IS PROVIDED WITHOUT WARRANTY OF ANY KIND. SENSOPIA DISCLAIMS ANY WARRANTY INCLUDING, WITHOUT LIMITATION, SATISFACTORY QUALITY OR ACCURACY OF DIMENSIONS.

# Outdoor Area

Width: 6.93 m  
 Length: 8.53 m  
 Area: 26.06 m<sup>2</sup>  
 Perimeter: 30.91 m

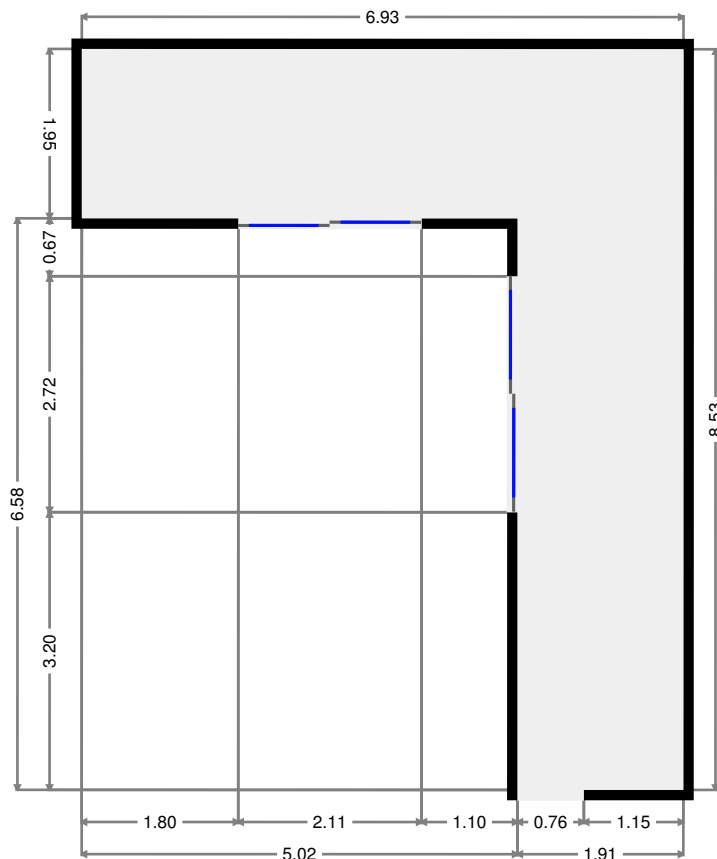
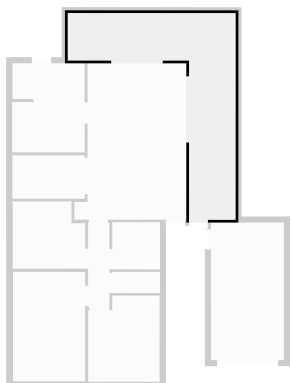

# Garage

Width: 3.01 m  
 Length: 5.68 m  
 Area: 17.14 m<sup>2</sup>  
 Perimeter: 17.40 m

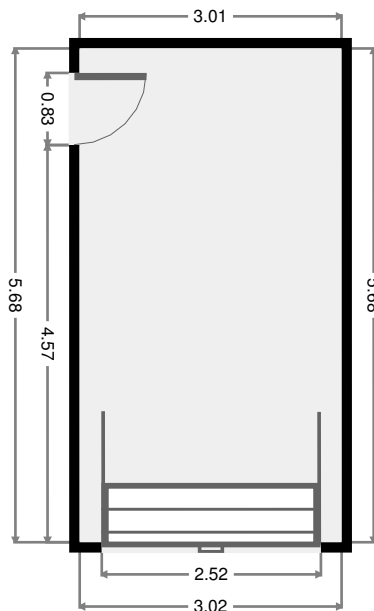
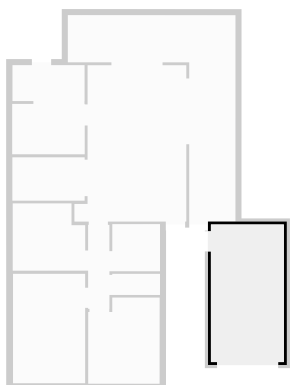

THIS FLOORPLAN IS PROVIDED WITHOUT WARRANTY OF ANY KIND. SENSOPIA DISCLAIMS ANY WARRANTY INCLUDING, WITHOUT LIMITATION, SATISFACTORY QUALITY OR ACCURACY OF DIMENSIONS.

