

107 Alexandra Street

SUBMITTED BY

Ray White Rockhampton Casey
stockers@cqoz.com

CREATED ON

2022-01-19

Floors

2

▼ Ground Floor

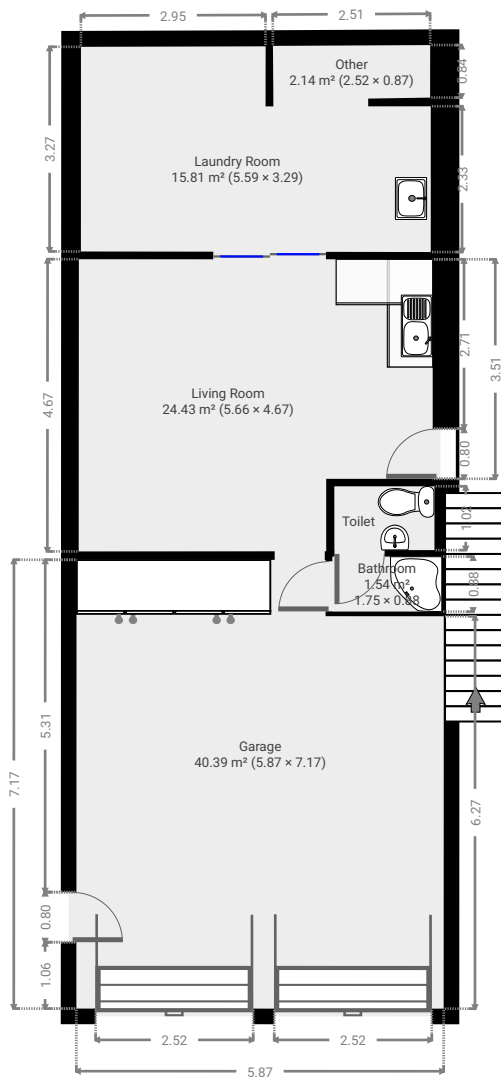
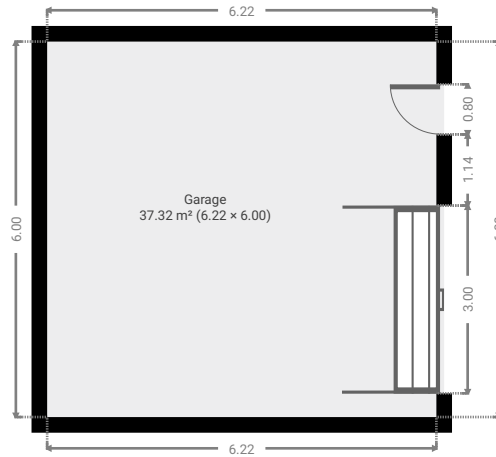

▼ **Garage**
Ground Floor

WIDTH: 5.87 m • LENGTH: 7.17 m
AREA: 40.39 m² • PERIMETER: 26.08 m

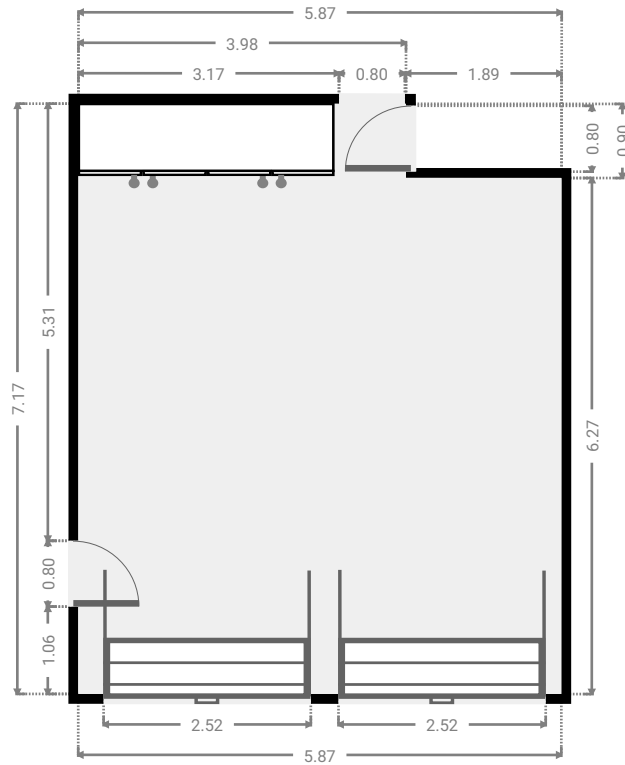
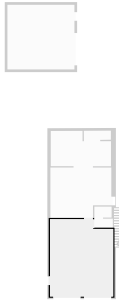

▼ **Bathroom**
Ground Floor

WIDTH: 1.75 m • LENGTH: 0.88 m
AREA: 1.54 m² • PERIMETER: 5.26 m

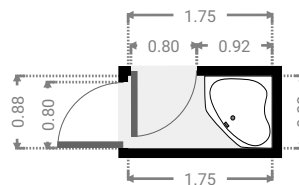

▼ **Toilet**
Ground Floor

WIDTH: 1.60 m • LENGTH: 1.02 m
AREA: 1.63 m² • PERIMETER: 5.24 m

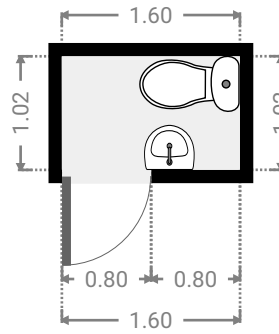

▼ **Living Room**
Ground Floor

WIDTH: 5.74 m • LENGTH: 4.67 m
AREA: 24.43 m² • PERIMETER: 20.65 m

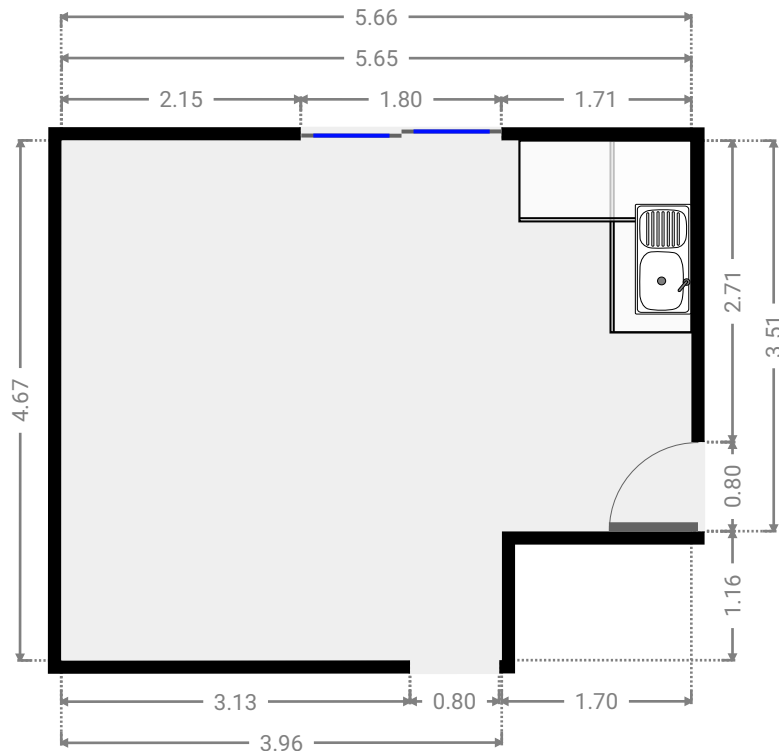

▼ **Laundry Room**
Ground Floor

WIDTH: 5.59 m • LENGTH: 3.29 m
AREA: 15.81 m² • PERIMETER: 17.74 m

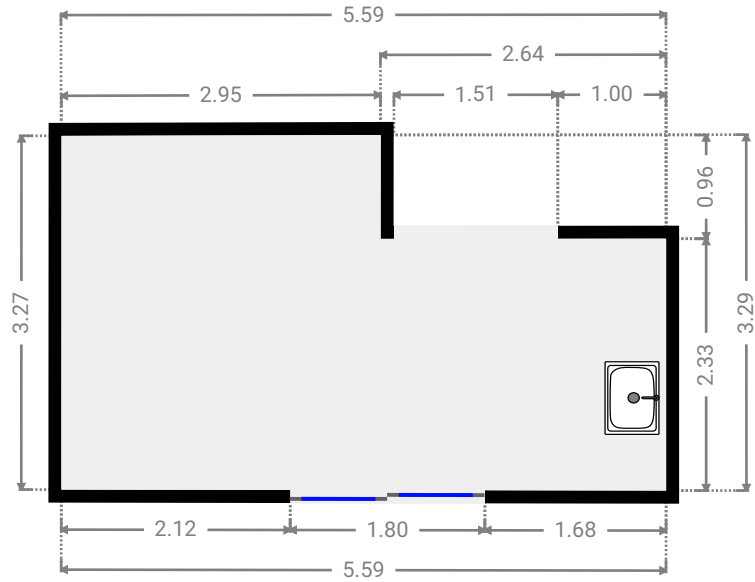

▼ **Garage**
Ground Floor

WIDTH: 6.22 m • LENGTH: 6.00 m
AREA: 37.32 m² • PERIMETER: 24.44 m

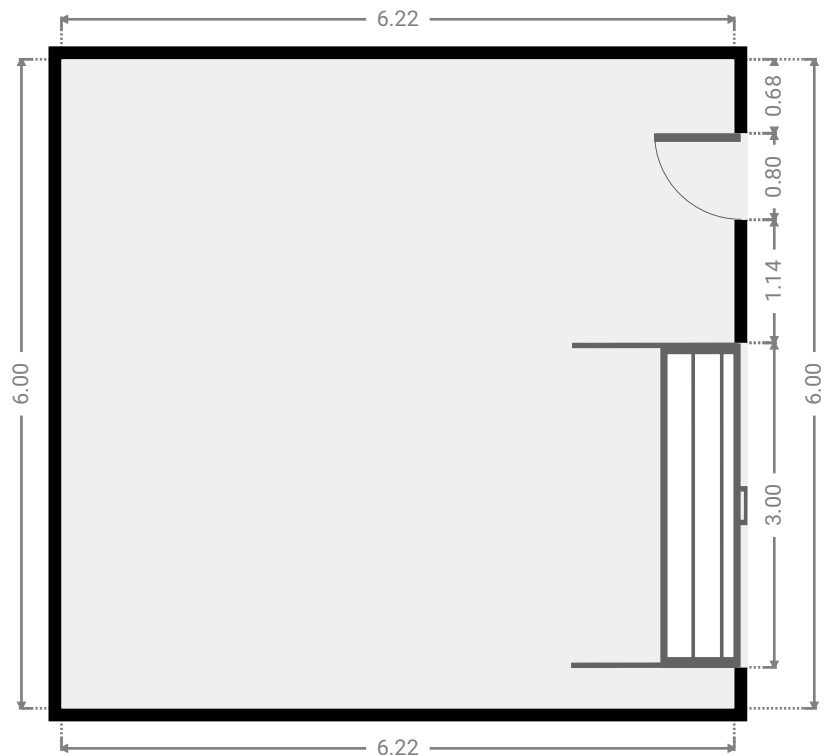

▼ Other
Ground Floor

WIDTH: 2.52 m • LENGTH: 0.87 m
AREA: 2.14 m² • PERIMETER: 6.72 m

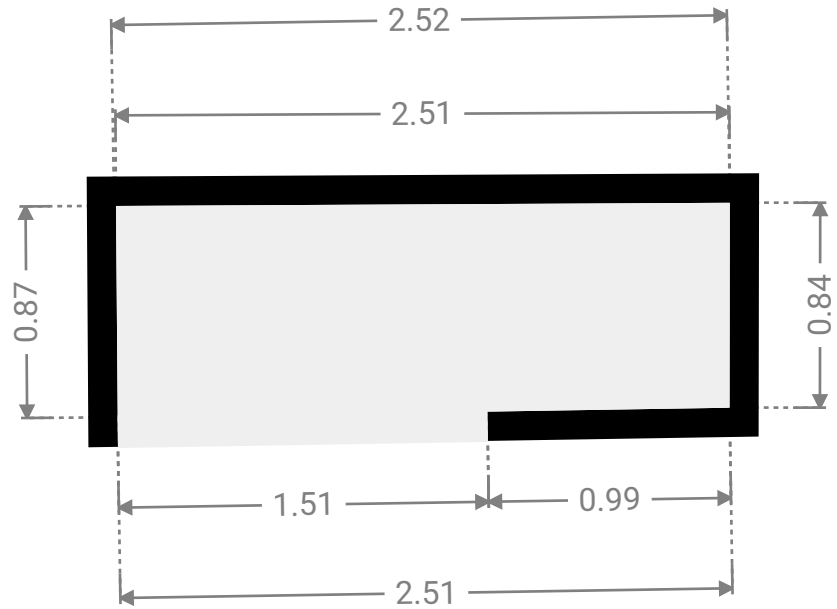

▼ 1st Floor

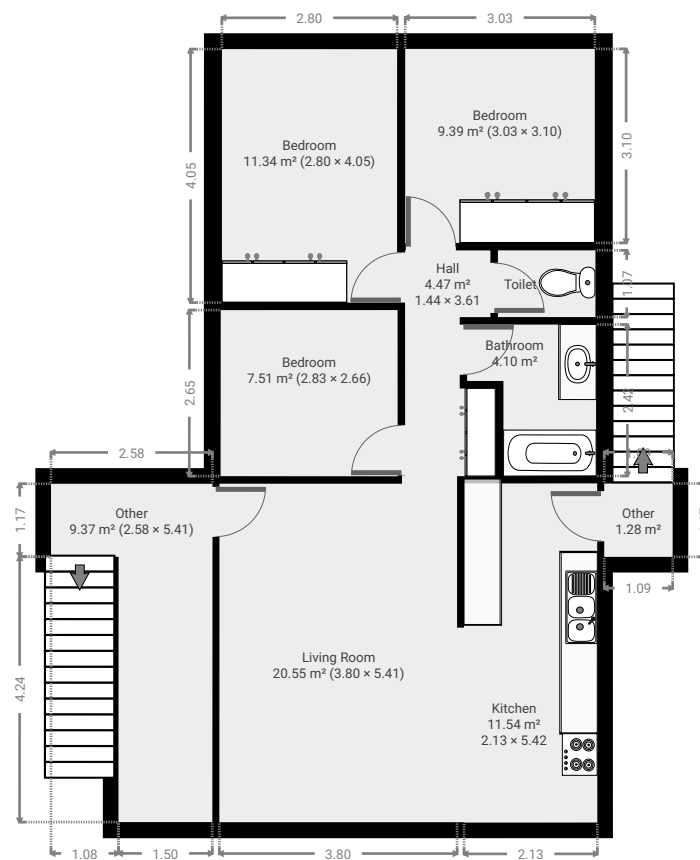

▼ **Living Room**
1st Floor

WIDTH: 3.80 m • LENGTH: 5.41 m
AREA: 20.55 m² • PERIMETER: 18.42 m

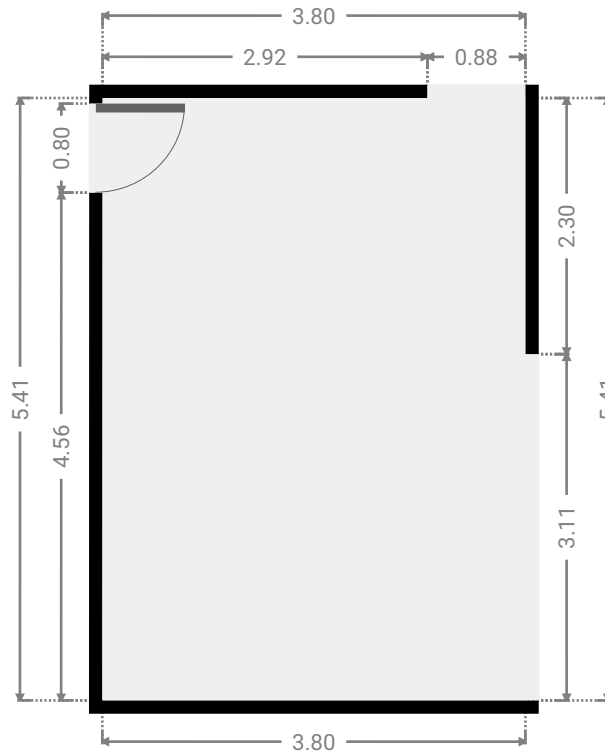
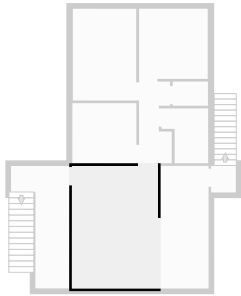

▼ **Kitchen**
1st Floor

WIDTH: 2.13 m • LENGTH: 5.42 m
AREA: 11.54 m² • PERIMETER: 15.10 m

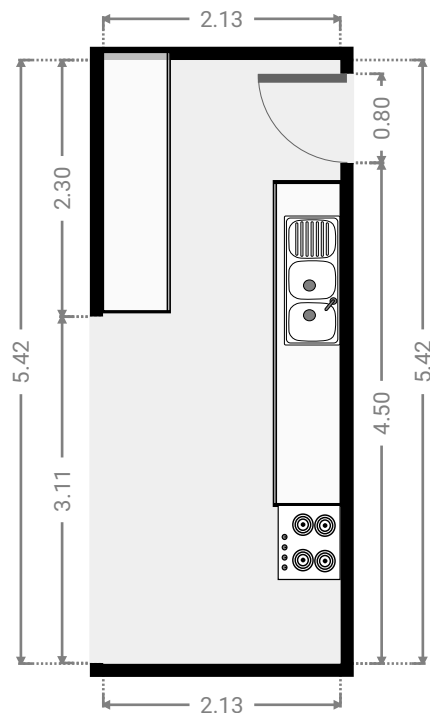
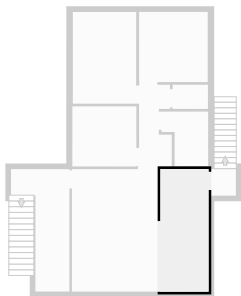

▼ **Hall**
1st Floor

WIDTH: 1.44 m • LENGTH: 3.61 m
AREA: 4.47 m² • PERIMETER: 11.08 m

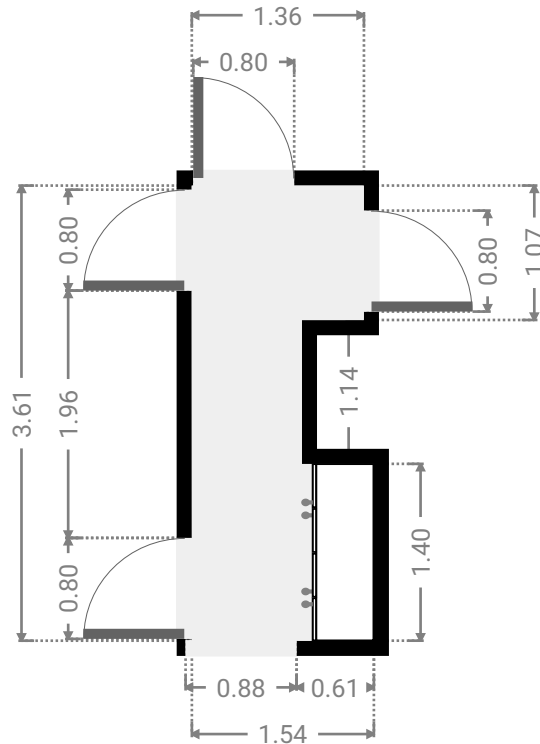
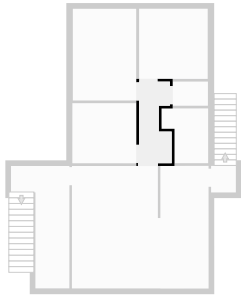

▼ **Bathroom**
1st Floor

WIDTH: 2.06 m • LENGTH: 2.42 m
AREA: 4.10 m² • PERIMETER: 8.96 m

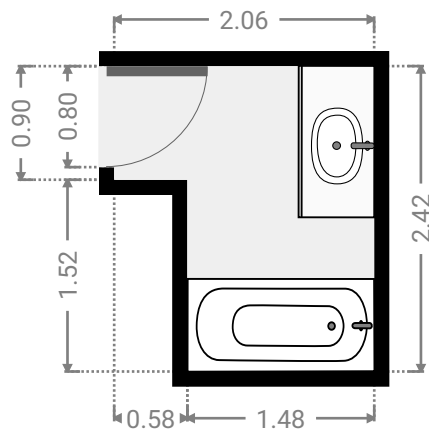
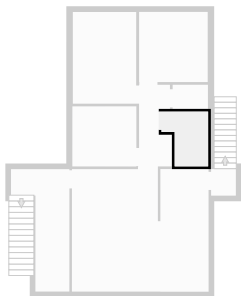

▼ **Toilet**
1st Floor

WIDTH: 1.56 m • LENGTH: 1.07 m
AREA: 1.66 m² • PERIMETER: 5.25 m

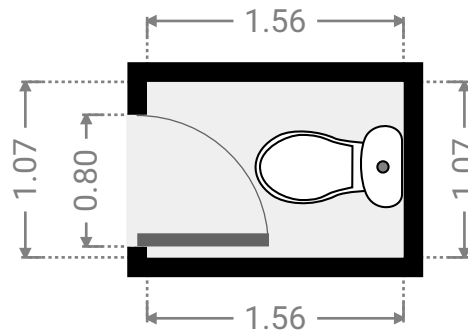
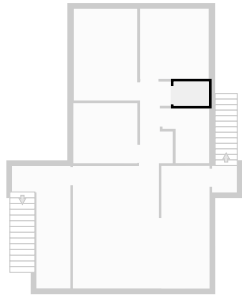

▼ **Bedroom**
1st Floor

WIDTH: 3.03 m • LENGTH: 3.10 m
AREA: 9.39 m² • PERIMETER: 12.26 m

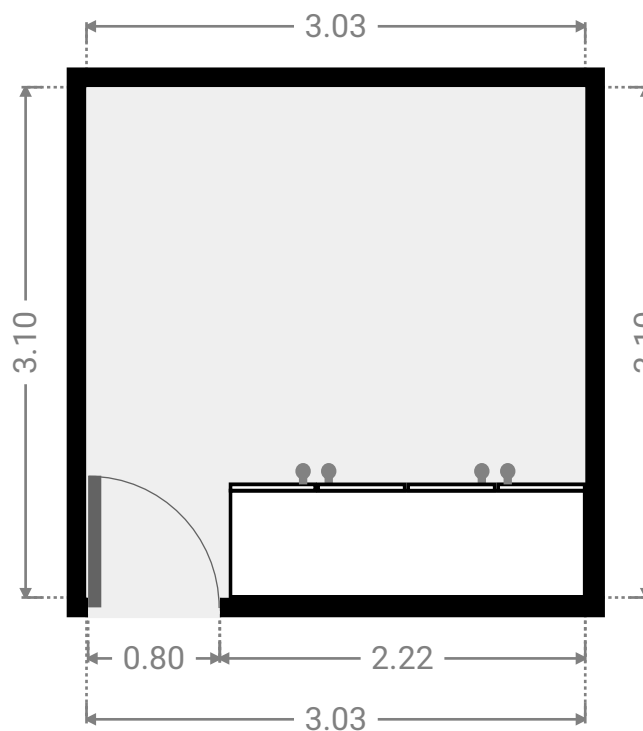
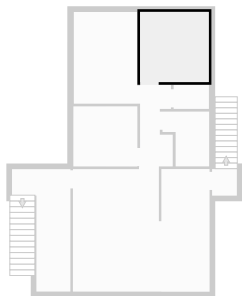

▼ Bedroom
1st Floor

WIDTH: 2.80 m • LENGTH: 4.05 m
AREA: 11.34 m² • PERIMETER: 13.70 m

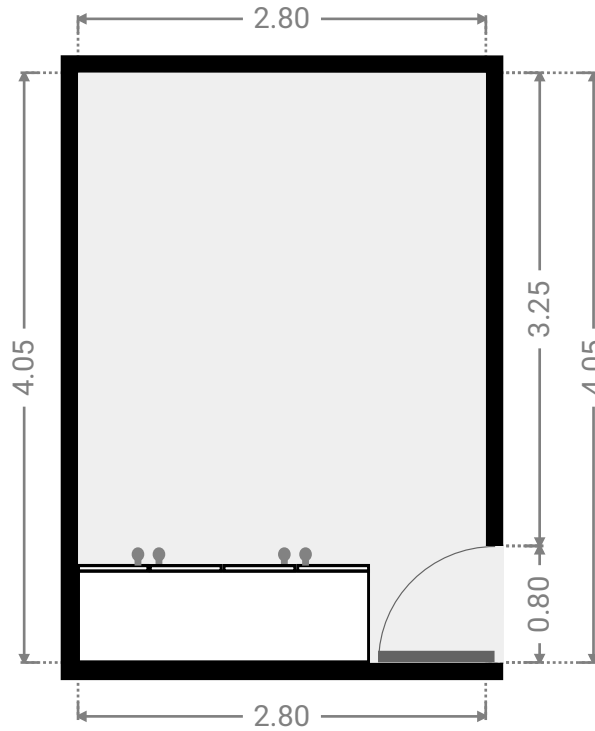
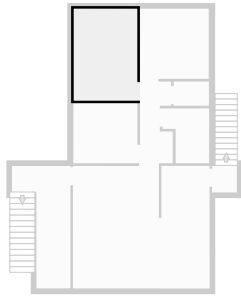

▼ Bedroom
1st Floor

WIDTH: 2.83 m • LENGTH: 2.66 m
AREA: 7.51 m² • PERIMETER: 10.97 m

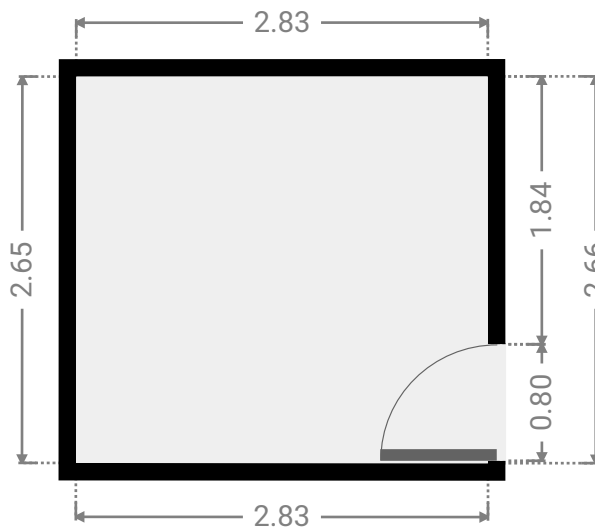
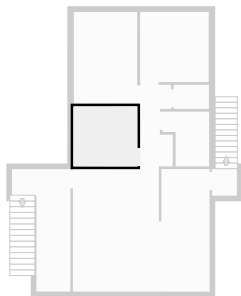

▼ Other
1st Floor

WIDTH: 2.58 m • LENGTH: 5.41 m
AREA: 9.37 m² • PERIMETER: 15.97 m

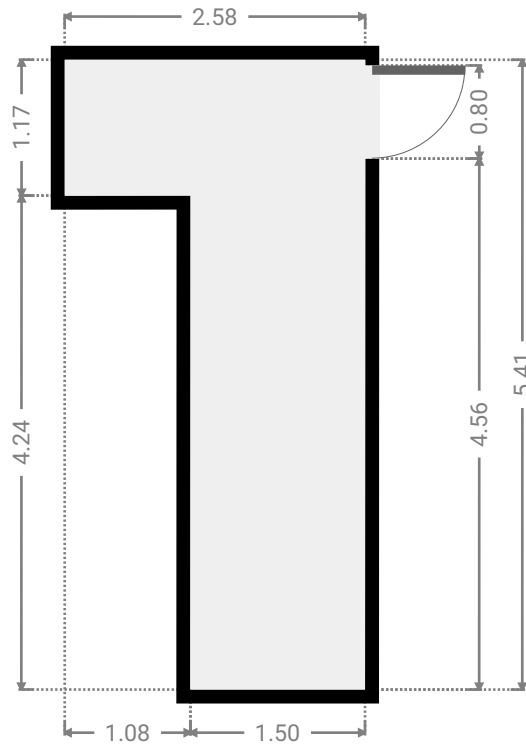
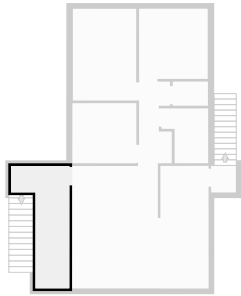

▼ Other
1st Floor

WIDTH: 1.09 m • LENGTH: 1.17 m
AREA: 1.28 m² • PERIMETER: 4.53 m

