

# 105 Main Street

## Ground Floor



THIS FLOORPLAN IS PROVIDED WITHOUT WARRANTY OF ANY KIND. SENSOPIA DISCLAIMS ANY WARRANTY INCLUDING, WITHOUT LIMITATION, SATISFACTORY QUALITY OR ACCURACY OF DIMENSIONS.



# 105 Main Street

## Living Room

Width: 3.68 m  
 Length: 6.39 m  
 Area: 19.03 m<sup>2</sup>  
 Perimeter: 20.14 m

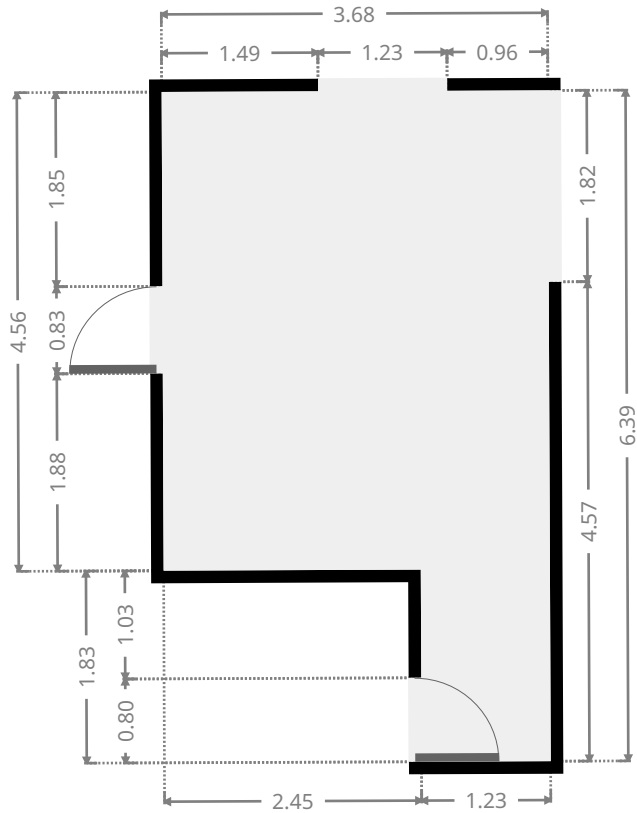
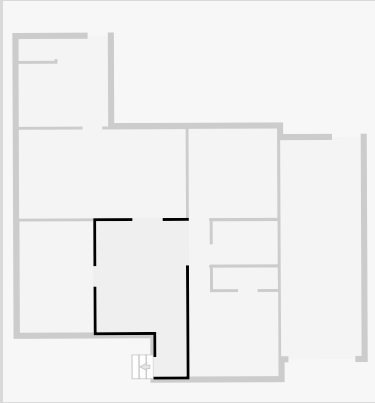

## Bedroom

Width: 3.03 m  
 Length: 4.57 m  
 Area: 13.85 m<sup>2</sup>  
 Perimeter: 15.20 m

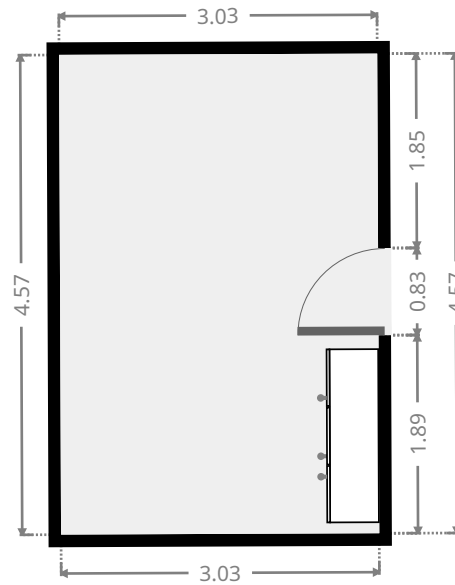
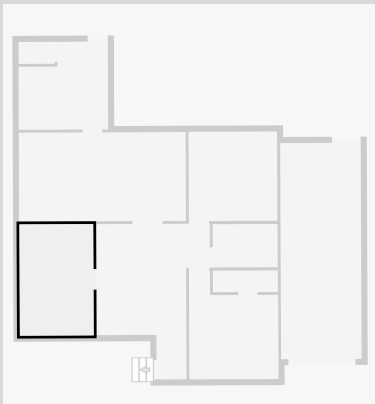

# 105 Main Street

## Hall

Width: 0.86 m  
 Length: 1.82 m  
 Area: 1.57 m<sup>2</sup>  
 Perimeter: 5.37 m

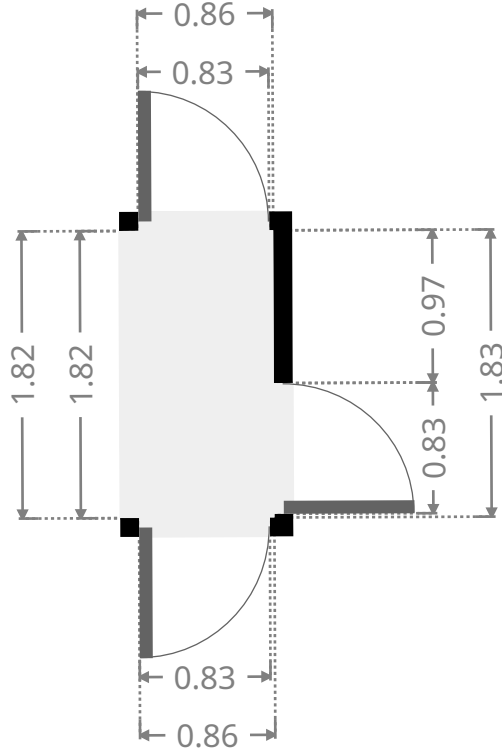
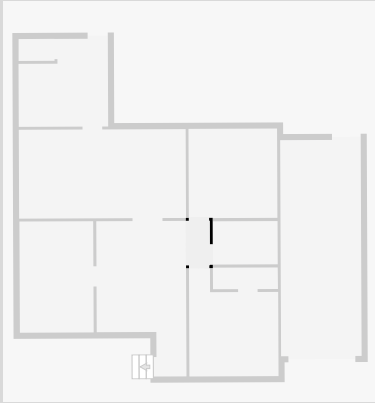

## Bedroom

Width: 3.64 m  
 Length: 3.67 m  
 Area: 13.36 m<sup>2</sup>  
 Perimeter: 14.62 m

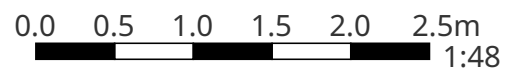
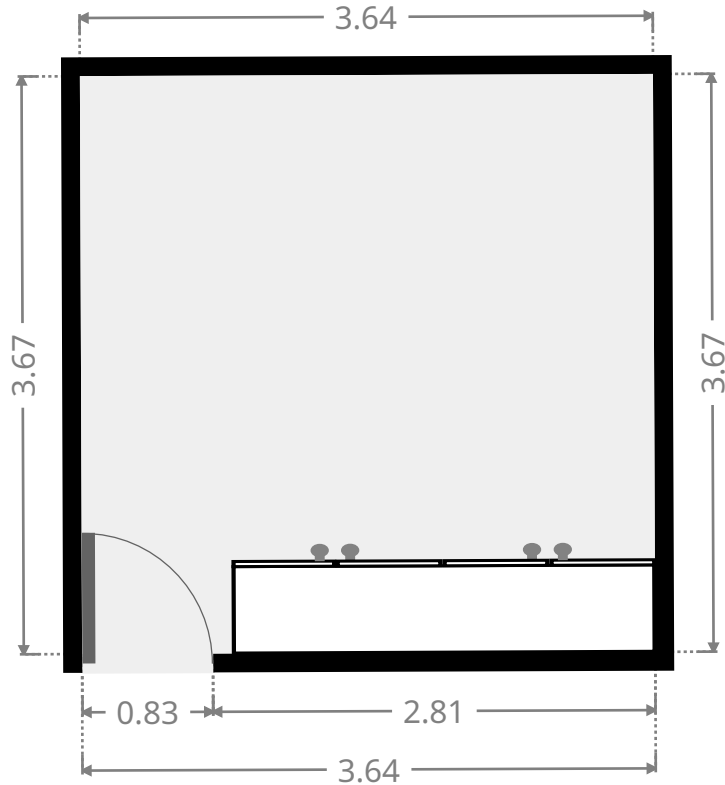
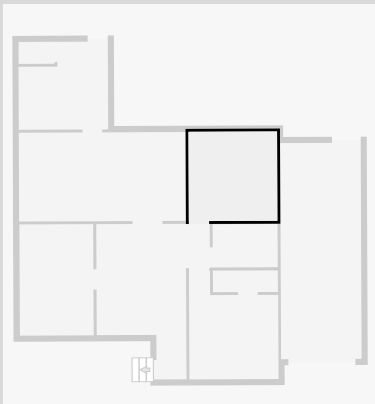

# 105 Main Street

## Bathroom

Width: 1.78 m  
 Length: 2.67 m  
 Area: 4.75 m<sup>2</sup>  
 Perimeter: 8.89 m

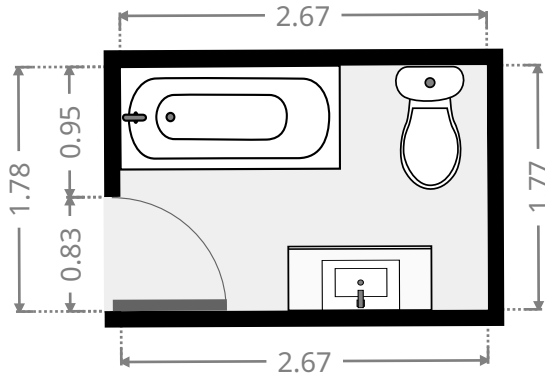
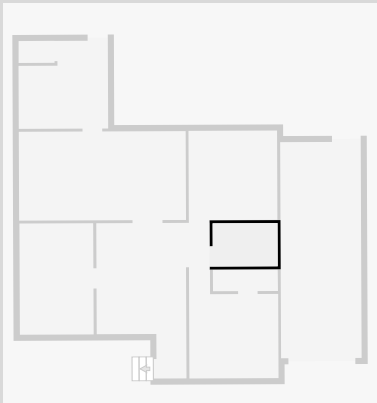

## Master Bedroom

Width: 3.66 m  
 Length: 4.46 m  
 Area: 13.54 m<sup>2</sup>  
 Perimeter: 16.25 m

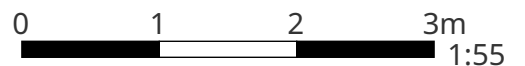
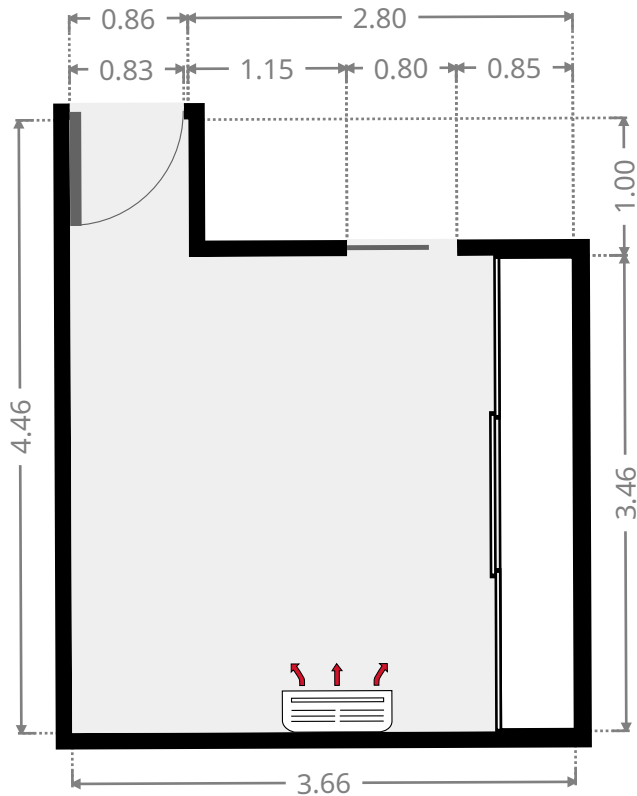
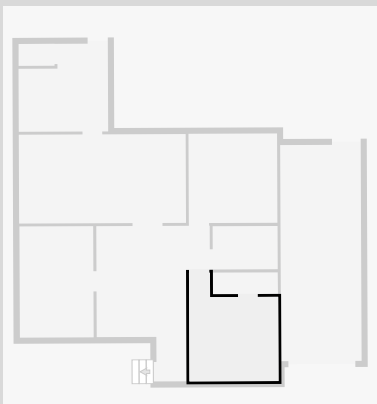

THIS FLOORPLAN IS PROVIDED WITHOUT WARRANTY OF ANY KIND. SENSOPIA DISCLAIMS ANY WARRANTY INCLUDING, WITHOUT LIMITATION, SATISFACTORY QUALITY OR ACCURACY OF DIMENSIONS.

# 105 Main Street

## Bathroom

Width: 0.91 m  
Length: 2.67 m  
Area: 2.36 m<sup>2</sup>  
Perimeter: 7.11 m

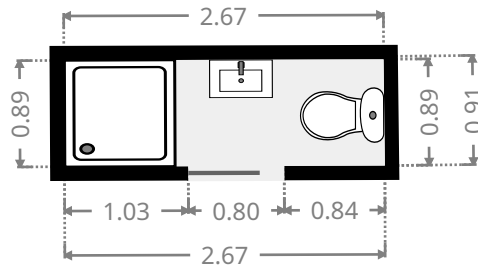
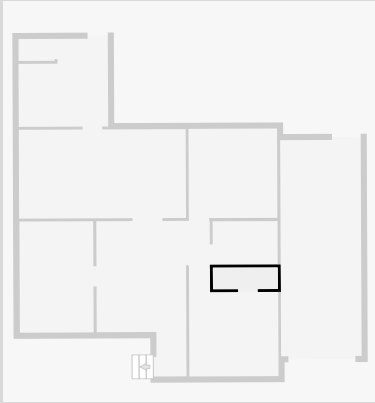

## Kitchen

Width: 3.65 m  
Length: 6.86 m  
Area: 25.04 m<sup>2</sup>  
Perimeter: 21.02 m

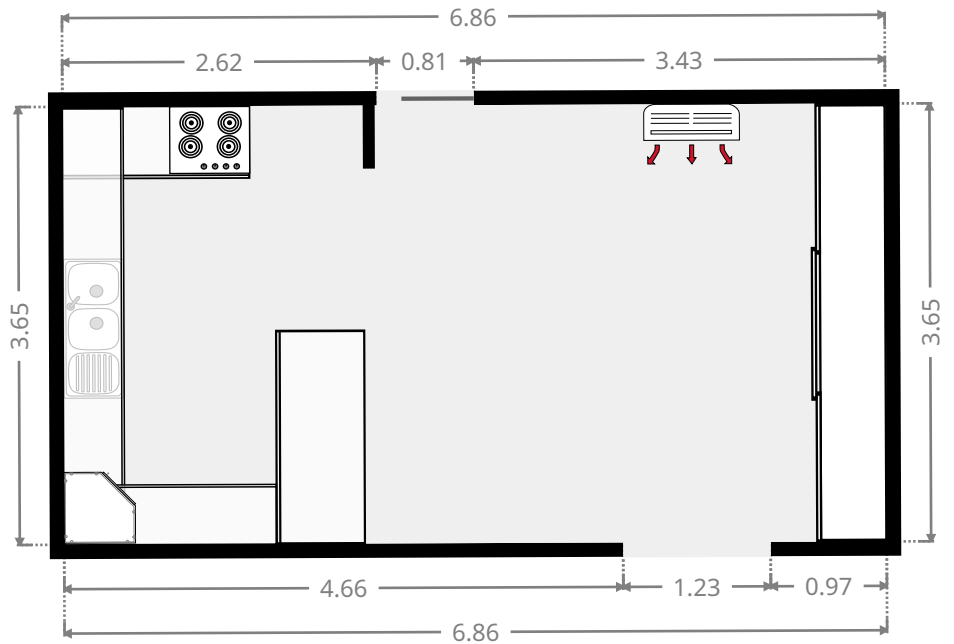
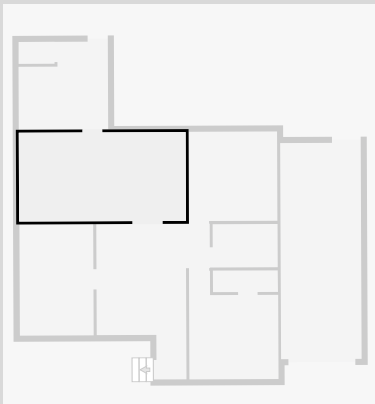

# 105 Main Street

## Laundry Room

Width: 3.61 m  
 Length: 3.67 m  
 Area: 11.63 m<sup>2</sup>  
 Perimeter: 14.57 m

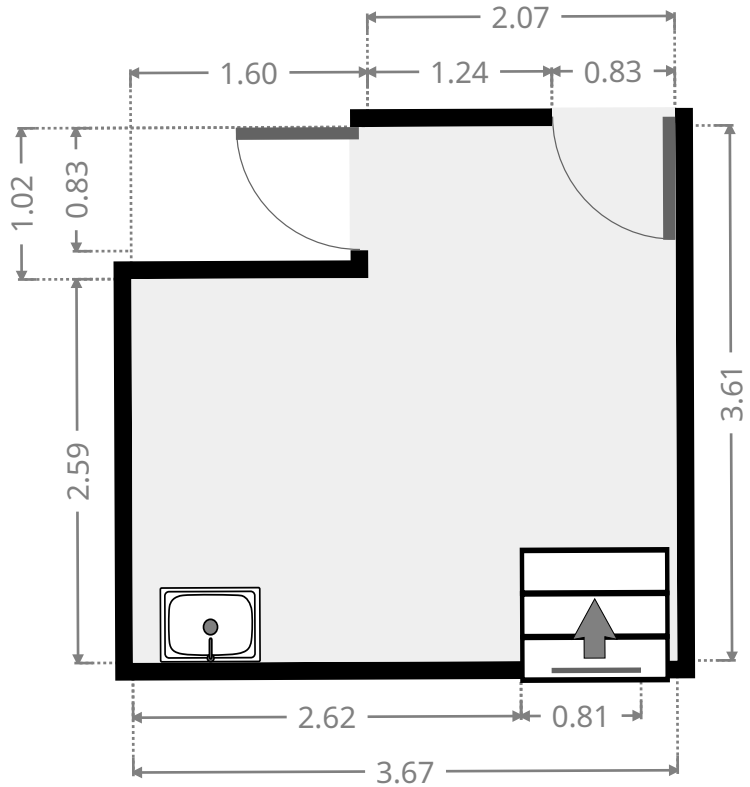
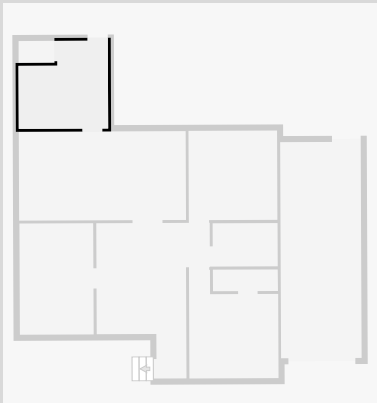

## Toilet / Half Bath

Width: 0.90 m  
 Length: 1.48 m  
 Area: 1.33 m<sup>2</sup>  
 Perimeter: 4.75 m

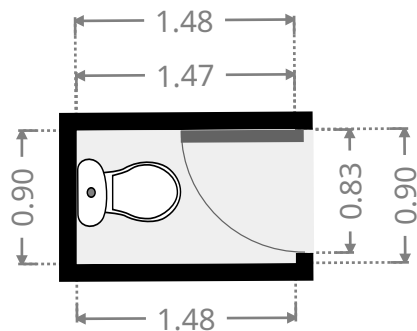
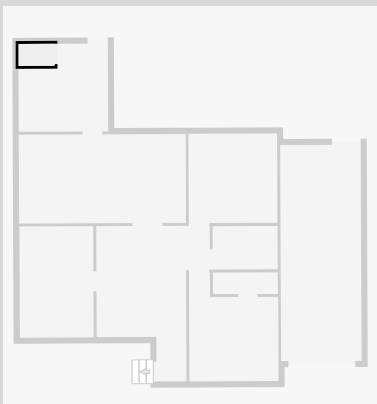

# 105 Main Street

## Garage

Width: 3.31 m  
Length: 8.88 m  
Area: 29.39 m<sup>2</sup>  
Perimeter: 24.38 m

