

105 Blanche Road

SUBMITTED BY

Ray White Rockhampton Casey
stockers@cqoz.com

CREATED ON

2022-05-06

Floors

2

▼ Ground Floor

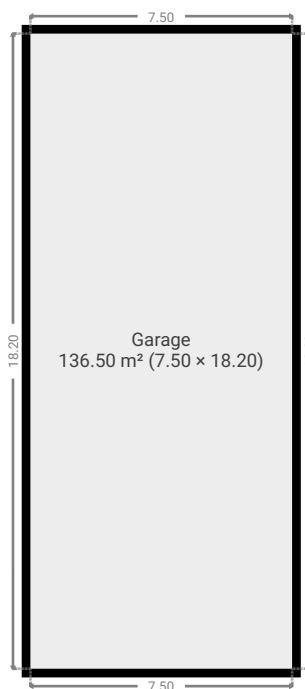
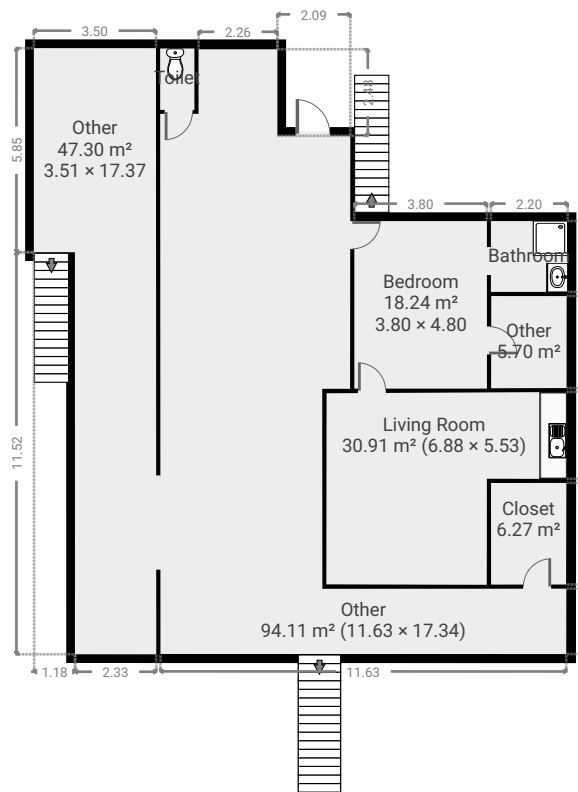

▼ **Other**
Ground Floor

WIDTH: 17.34 m • LENGTH: 11.63 m
AREA: 94.11 m² • PERIMETER: 59.53 m

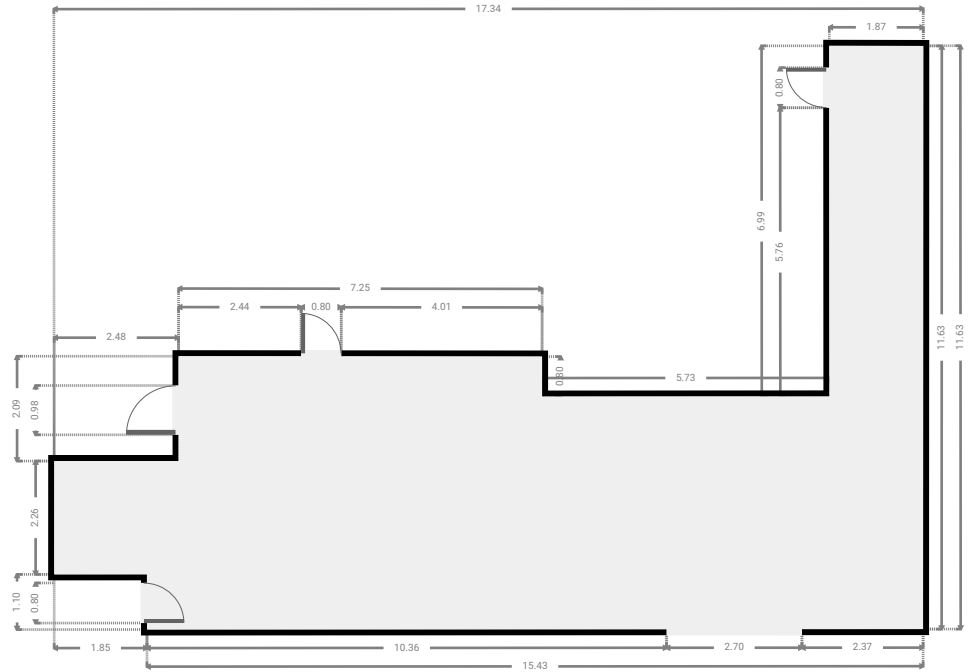
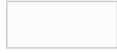

▼ **Toilet**
Ground Floor

WIDTH: 1.76 m • LENGTH: 0.98 m
AREA: 1.72 m² • PERIMETER: 5.48 m

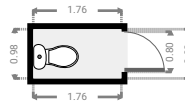
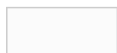

▼ Living Room
Ground Floor

WIDTH: 5.53 m • LENGTH: 6.88 m
AREA: 30.91 m² • PERIMETER: 24.75 m

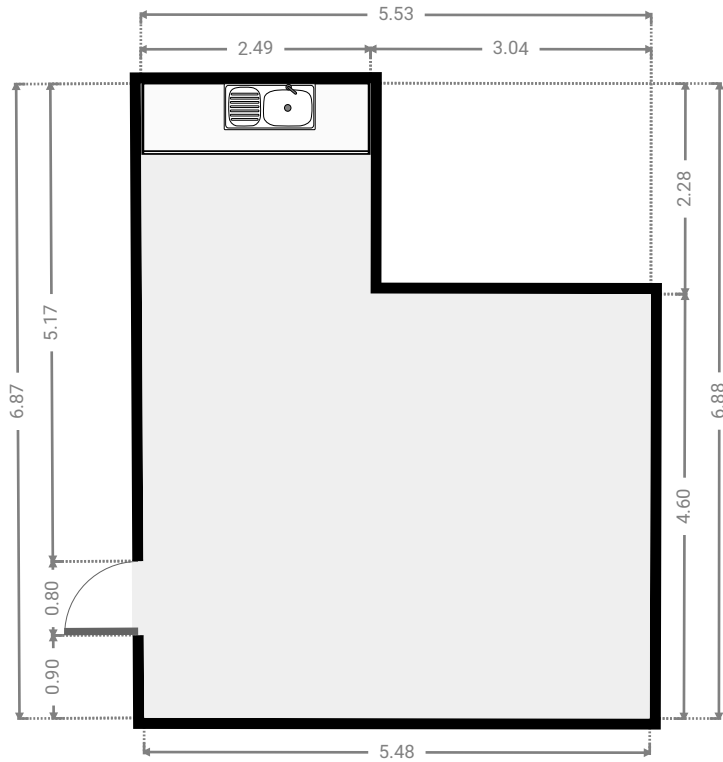
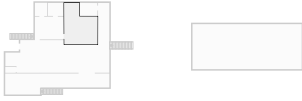

▼ Bedroom
Ground Floor

WIDTH: 4.80 m • LENGTH: 3.80 m
AREA: 18.24 m² • PERIMETER: 17.20 m

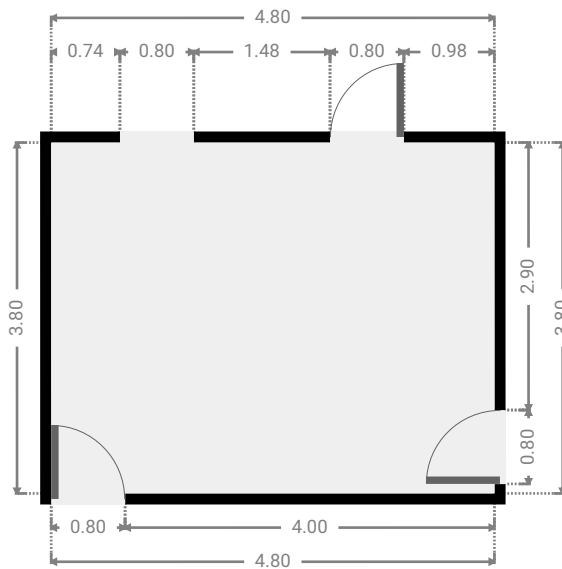
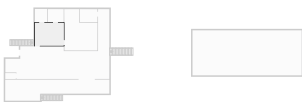

▼ **Bathroom**
Ground Floor

WIDTH: 2.03 m • LENGTH: 2.20 m
AREA: 4.47 m² • PERIMETER: 8.46 m

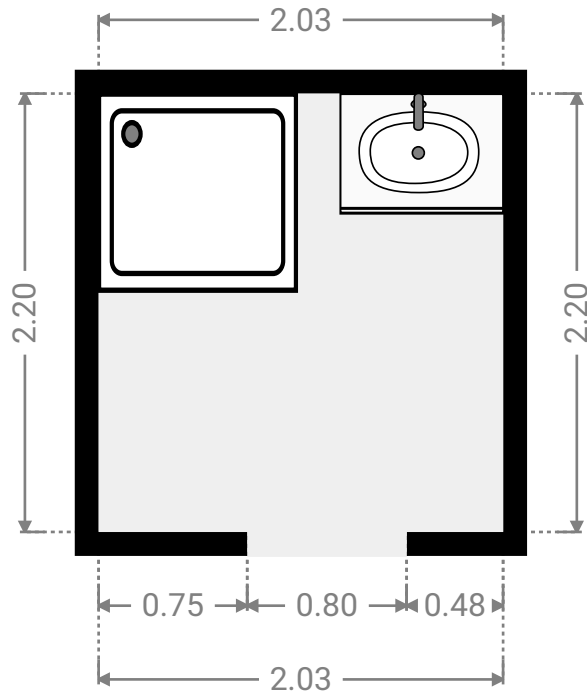
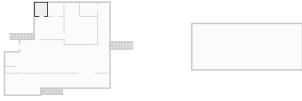

▼ **Other**
Ground Floor

WIDTH: 2.64 m • LENGTH: 2.17 m
AREA: 5.70 m² • PERIMETER: 9.60 m

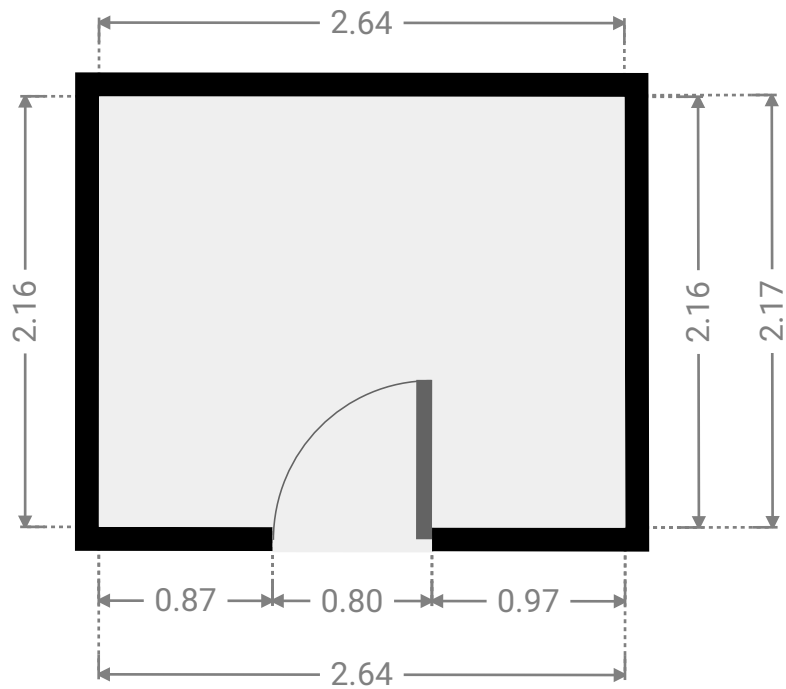
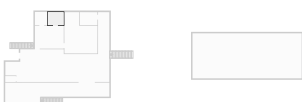

▼ **Closet**
Ground Floor

WIDTH: 2.91 m • LENGTH: 2.16 m
AREA: 6.27 m² • PERIMETER: 10.13 m

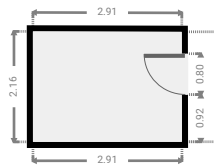
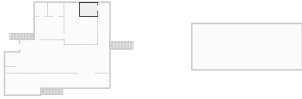

▼ **Other**
Ground Floor

WIDTH: 17.37 m • LENGTH: 3.51 m
AREA: 47.30 m² • PERIMETER: 41.75 m

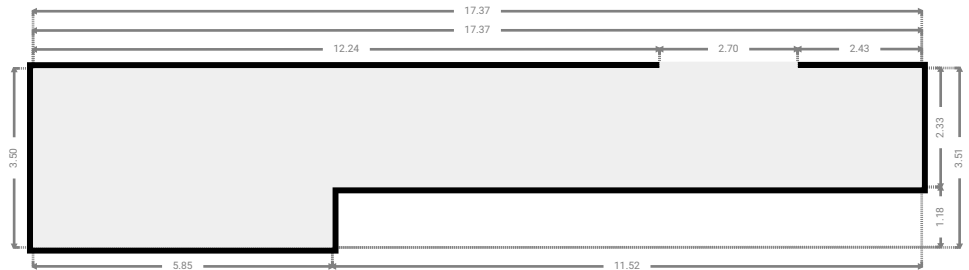
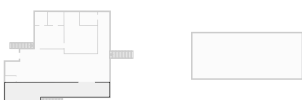

▼ **Garage**
Ground Floor

WIDTH: 18.20 m • LENGTH: 7.50 m
AREA: 136.50 m² • PERIMETER: 51.40 m



▼ 1st Floor

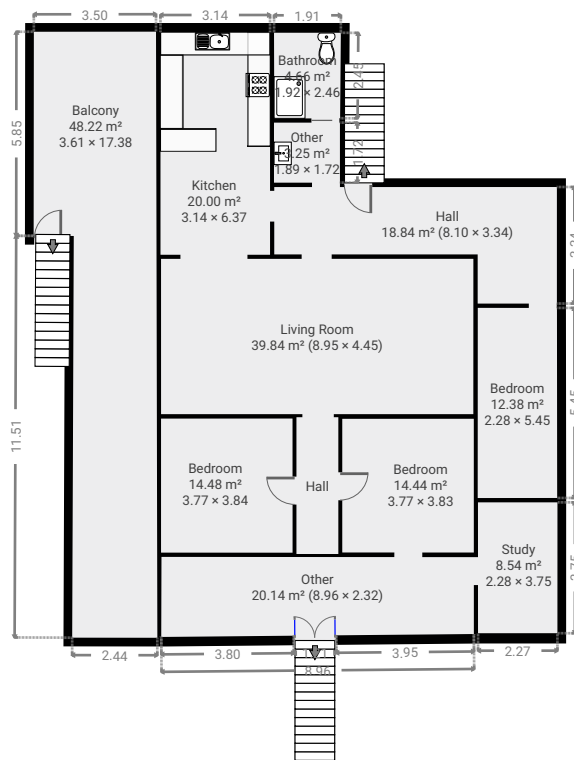

▼ **Balcony**
1st Floor

WIDTH: 17.38 m • LENGTH: 3.61 m
AREA: 48.22 m² • PERIMETER: 41.82 m

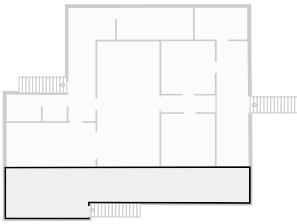

▼ **Kitchen**
1st Floor

WIDTH: 6.37 m • LENGTH: 3.14 m
AREA: 20.00 m² • PERIMETER: 19.02 m

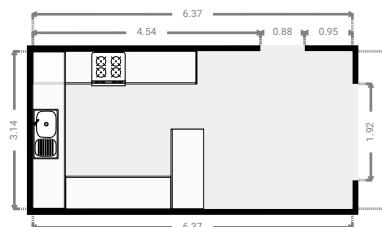
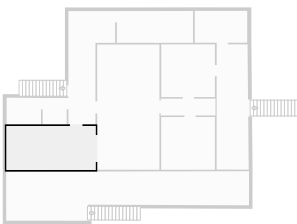

▼ Living Room
1st Floor

WIDTH: 4.45 m • LENGTH: 8.95 m
AREA: 39.84 m² • PERIMETER: 26.80 m

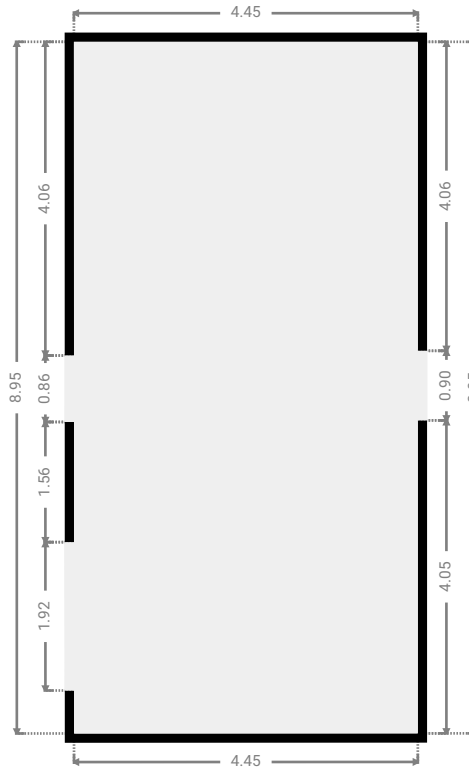
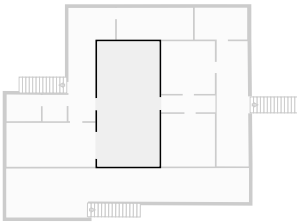

▼ Hall
1st Floor

WIDTH: 3.92 m • LENGTH: 1.20 m
AREA: 4.70 m² • PERIMETER: 10.24 m

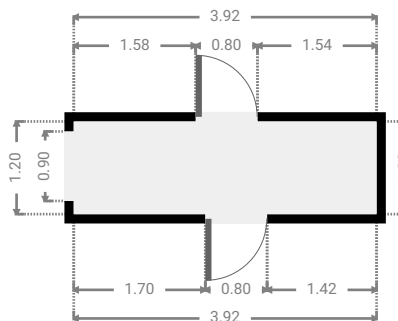
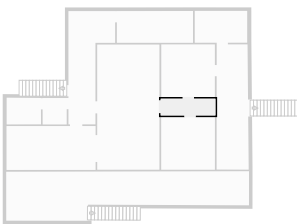

▼ Hall
1st Floor

WIDTH: 3.34 m • LENGTH: 8.10 m
AREA: 18.84 m² • PERIMETER: 22.88 m

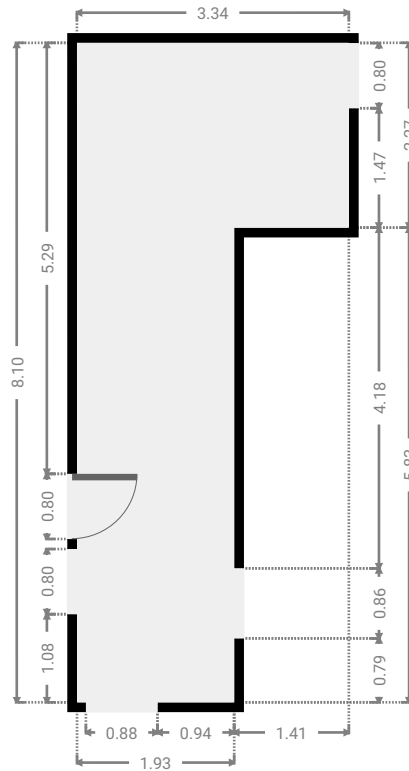
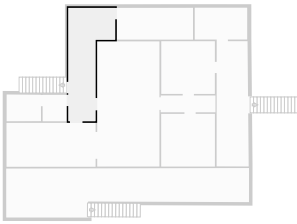

▼ Other
1st Floor

WIDTH: 1.72 m • LENGTH: 1.89 m
AREA: 3.25 m² • PERIMETER: 7.22 m

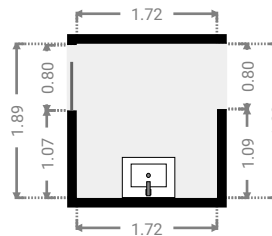
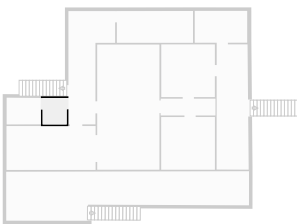

▼ **Bathroom**
1st Floor

WIDTH: 2.46 m • LENGTH: 1.92 m
AREA: 4.66 m² • PERIMETER: 8.71 m

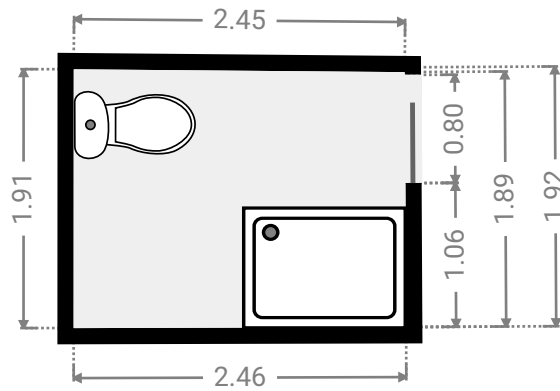
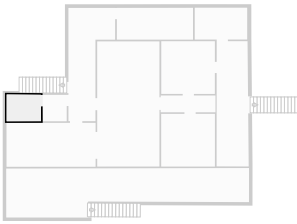

▼ **Bedroom**
1st Floor

WIDTH: 5.45 m • LENGTH: 2.28 m
AREA: 12.38 m² • PERIMETER: 15.44 m

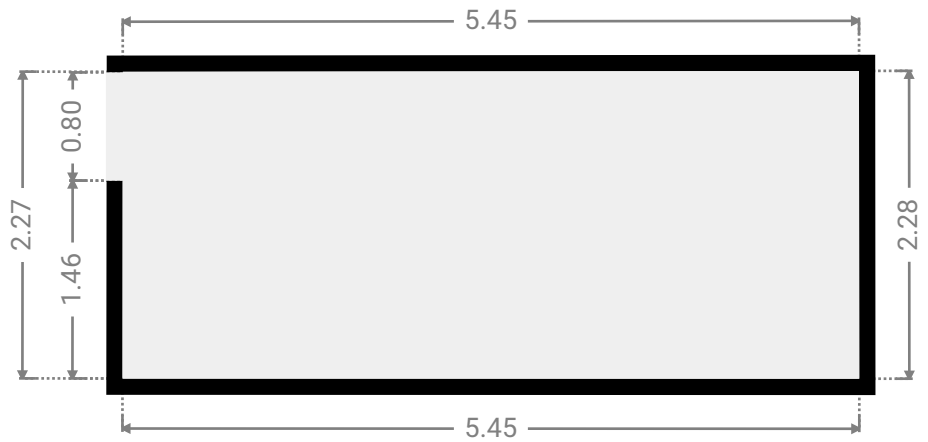
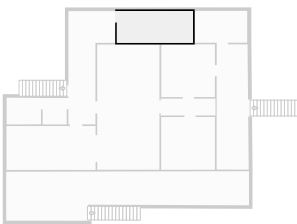

▼ **Bedroom**
1st Floor

WIDTH: 3.83 m • LENGTH: 3.77 m
AREA: 14.44 m² • PERIMETER: 15.20 m

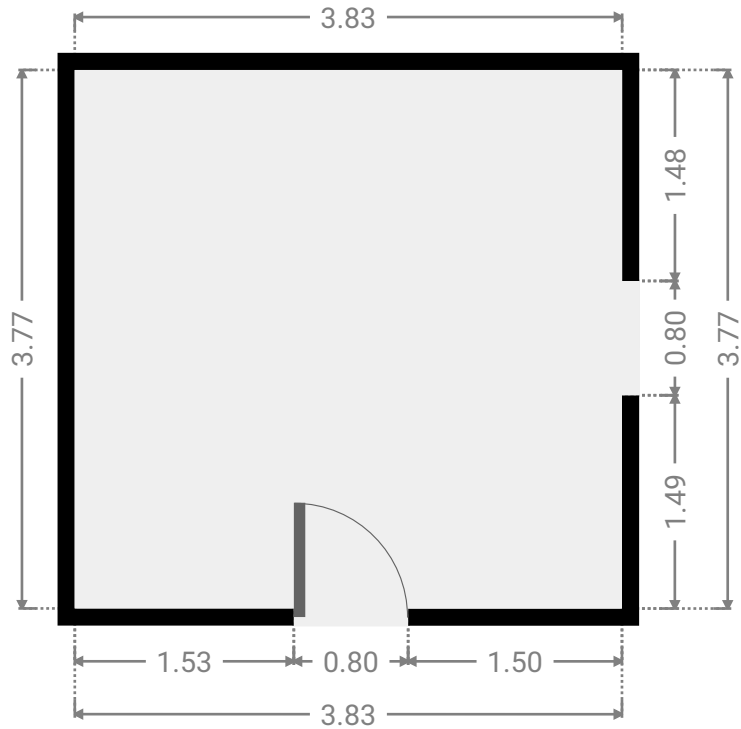
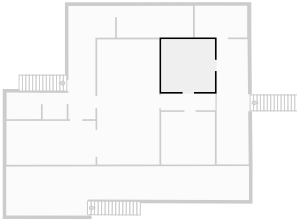

▼ **Bedroom**
1st Floor

WIDTH: 3.84 m • LENGTH: 3.77 m
AREA: 14.48 m² • PERIMETER: 15.22 m

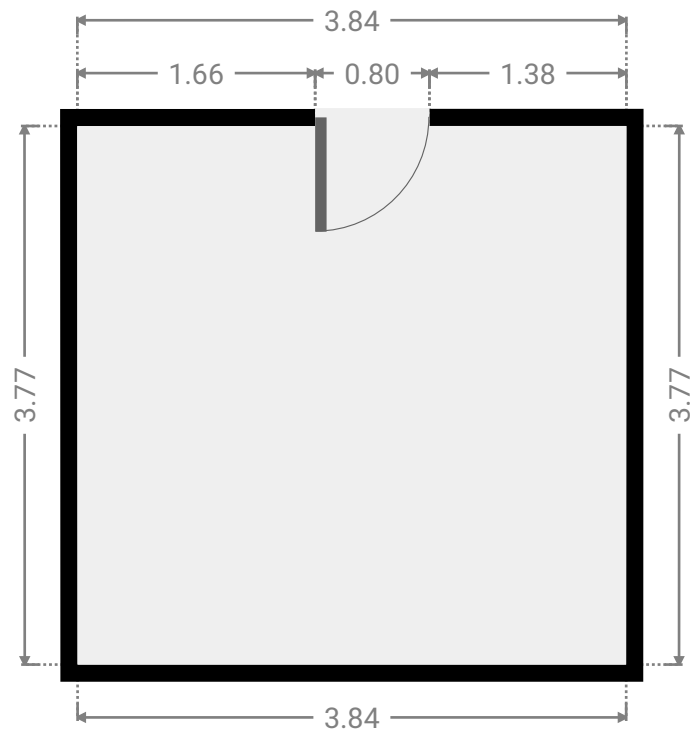
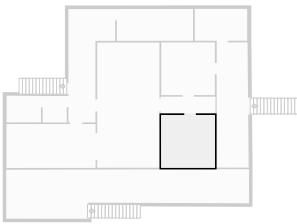

▼ **Study**
1st Floor

WIDTH: 3.75 m • LENGTH: 2.28 m
AREA: 8.54 m² • PERIMETER: 12.05 m

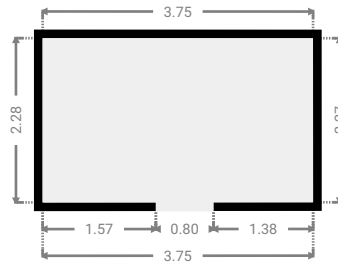
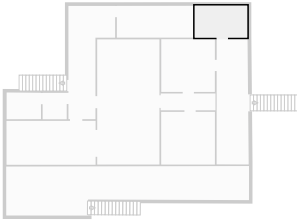

▼ **Other**
1st Floor

WIDTH: 2.32 m • LENGTH: 8.96 m
AREA: 20.14 m² • PERIMETER: 22.41 m

