

10 Trinity Avenue

Created on
2020-09-08

Floors

1

▼ Ground Floor

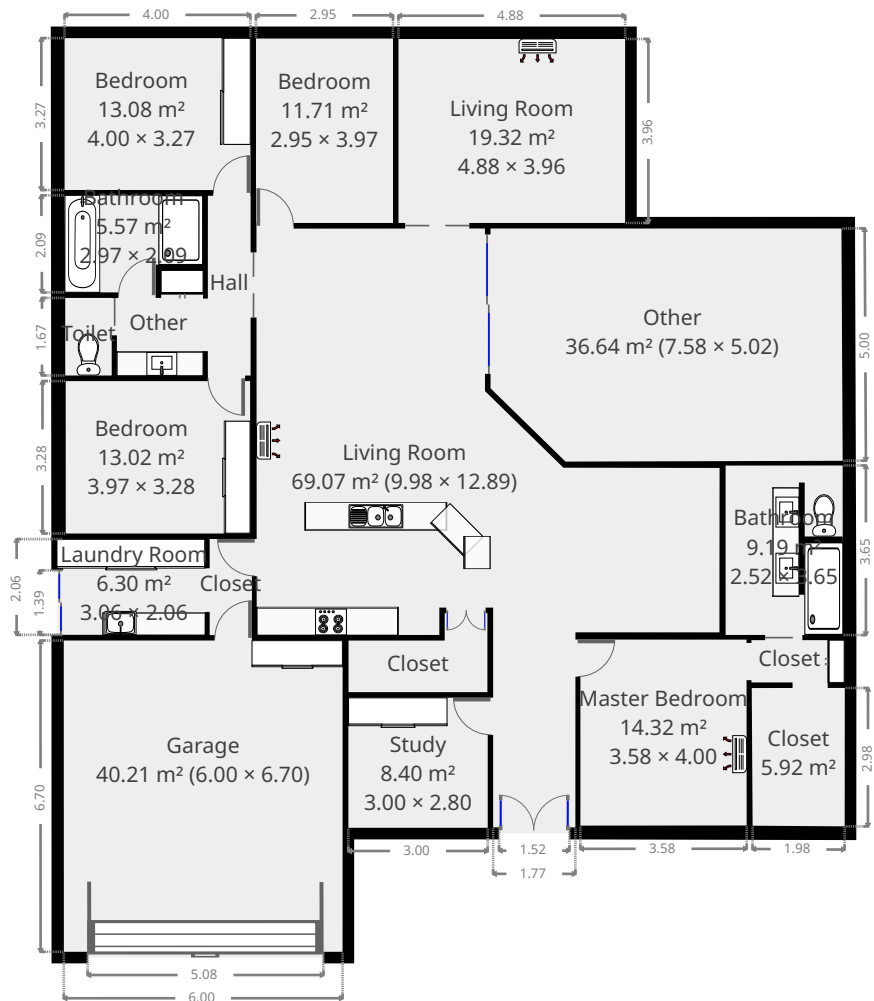
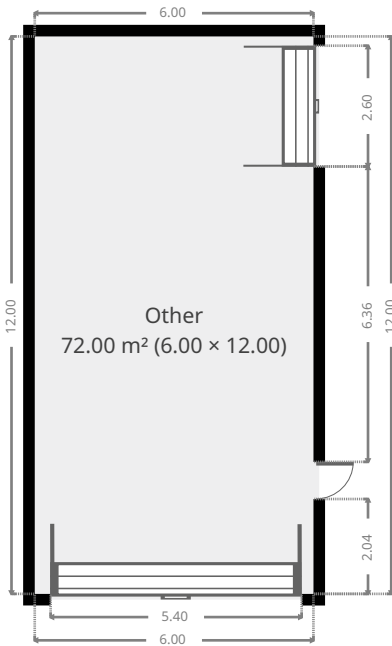

THIS FLOORPLAN IS PROVIDED WITHOUT WARRANTY OF ANY KIND. SENSOPIA DISCLAIMS ANY WARRANTY INCLUDING, WITHOUT LIMITATION, SATISFACTORY QUALITY OR ACCURACY OF DIMENSIONS.

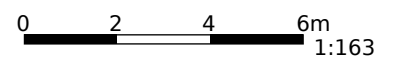

FLOORS: 1

▼ Living Room Ground Floor

WIDTH: 4.88 m • LENGTH: 3.96 m
AREA: 19.32 m² • PERIMETER: 17.68 m

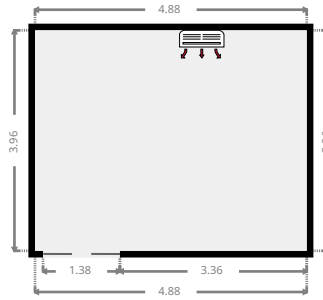

▼ Other Ground Floor

WIDTH: 6.00 m • LENGTH: 12.00 m
AREA: 72.00 m² • PERIMETER: 36.00 m

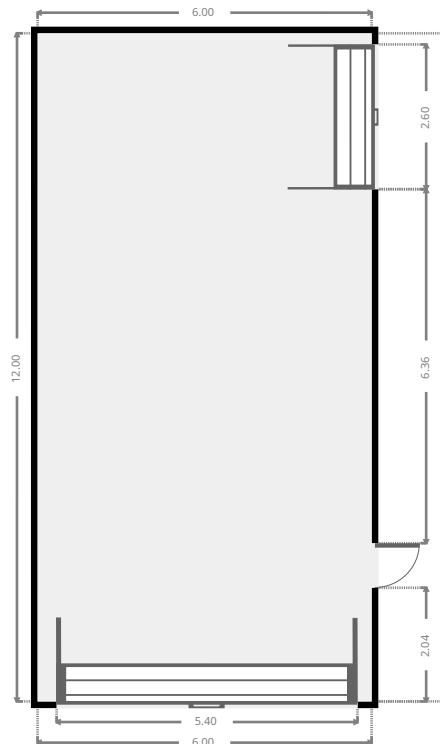
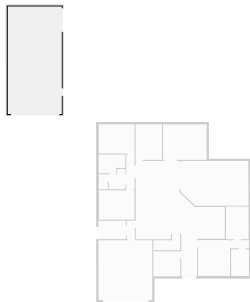

THIS FLOORPLAN IS PROVIDED WITHOUT WARRANTY OF ANY KIND. SENSOPIA DISCLAIMS ANY WARRANTY INCLUDING, WITHOUT LIMITATION, SATISFACTORY QUALITY OR ACCURACY OF DIMENSIONS.

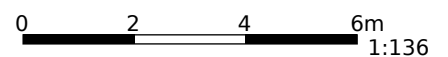

FLOORS: 1

▼ **Other**
Ground Floor

WIDTH: 7.58 m • **LENGTH:** 5.02 m
AREA: 36.64 m² • **PERIMETER:** 24.22 m

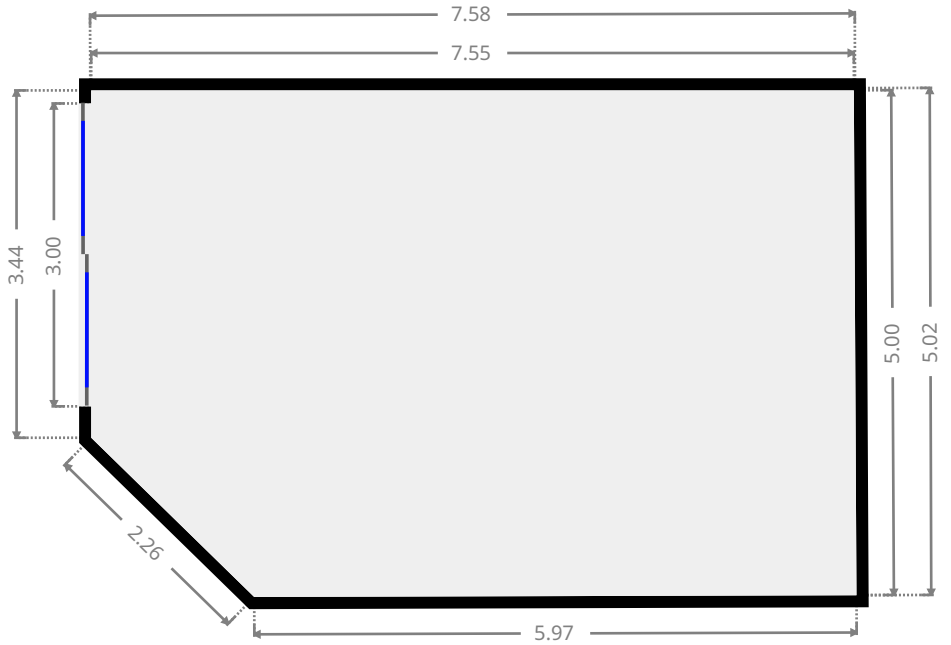
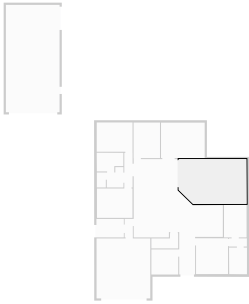

▼ **Bedroom**
Ground Floor

WIDTH: 2.95 m • **LENGTH:** 3.97 m
AREA: 11.71 m² • **PERIMETER:** 13.84 m

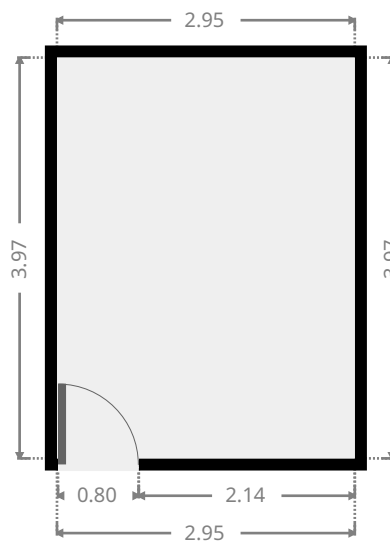
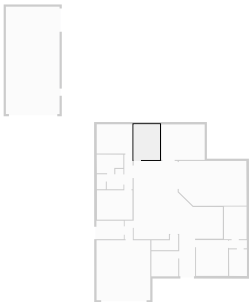

FLOORS: 1

▼ **Bedroom**
Ground Floor

WIDTH: 4.00 m • LENGTH: 3.27 m
AREA: 13.08 m² • PERIMETER: 14.54 m

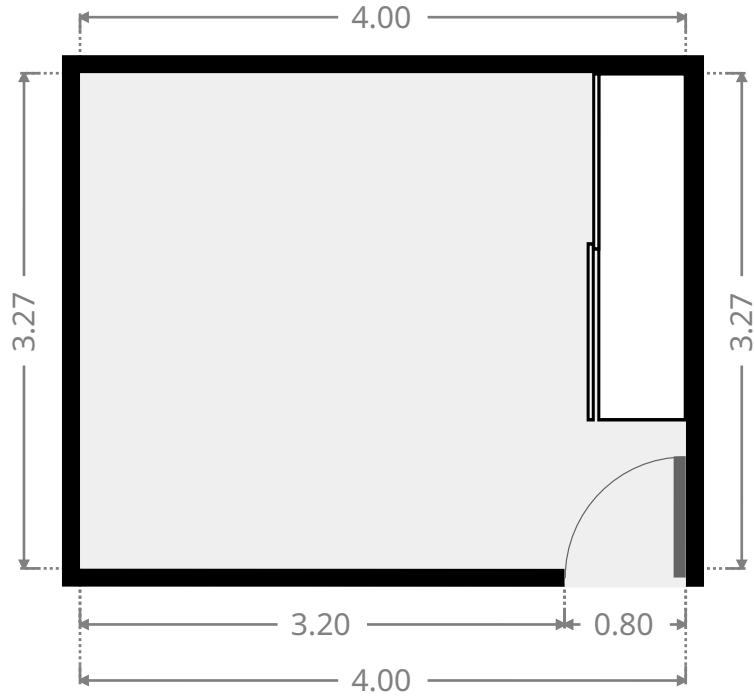

▼ **Bathroom**
Ground Floor

WIDTH: 2.97 m • LENGTH: 2.09 m
AREA: 5.57 m² • PERIMETER: 10.10 m

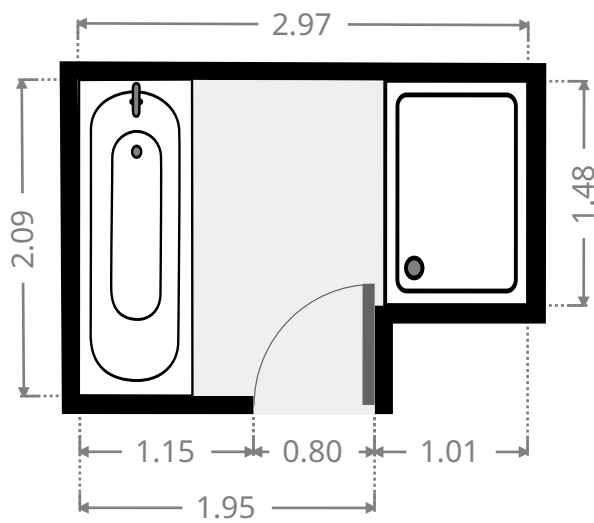
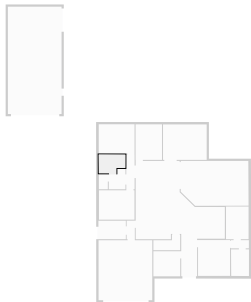

FLOORS: 1

▼ **Toilet**
Ground Floor

WIDTH: 1.00 m • **LENGTH:** 1.67 m
AREA: 1.67 m² • **PERIMETER:** 5.34 m

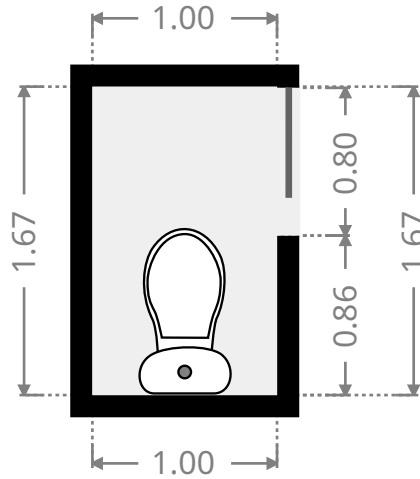

▼ **Other**
Ground Floor

WIDTH: 1.86 m • **LENGTH:** 2.27 m
AREA: 3.64 m² • **PERIMETER:** 8.25 m

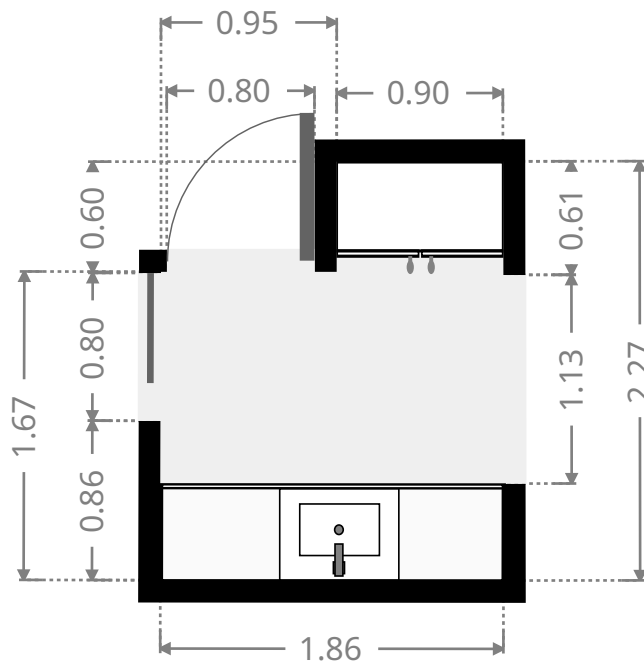

FLOORS: 1

▼ **Bedroom**
Ground Floor

WIDTH: 3.97 m • LENGTH: 3.28 m
AREA: 13.02 m² • PERIMETER: 14.50 m

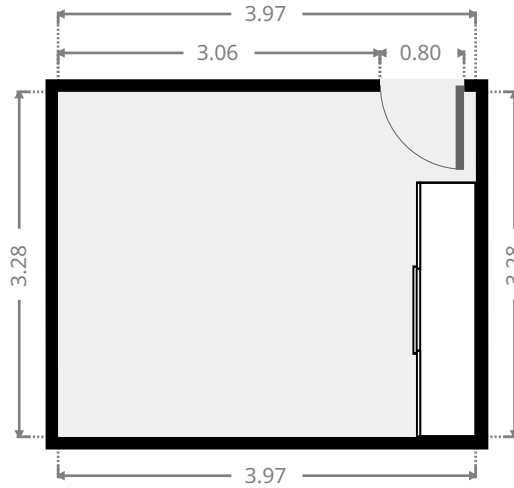
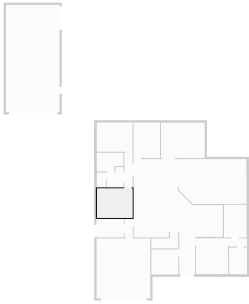

▼ **Hall**
Ground Floor

WIDTH: 0.92 m • LENGTH: 3.87 m
AREA: 3.56 m² • PERIMETER: 9.58 m

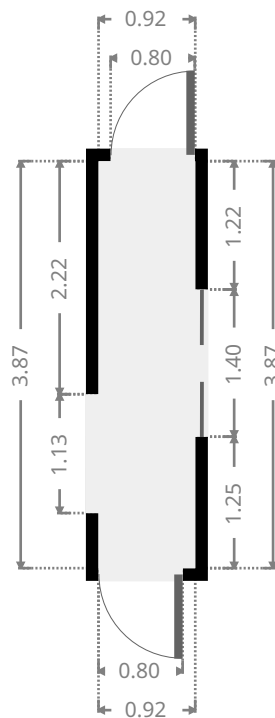

FLOORS: 1

▼ Living Room Ground Floor

WIDTH: 9.98 m • LENGTH: 12.89 m
AREA: 69.07 m² • PERIMETER: 45.91 m

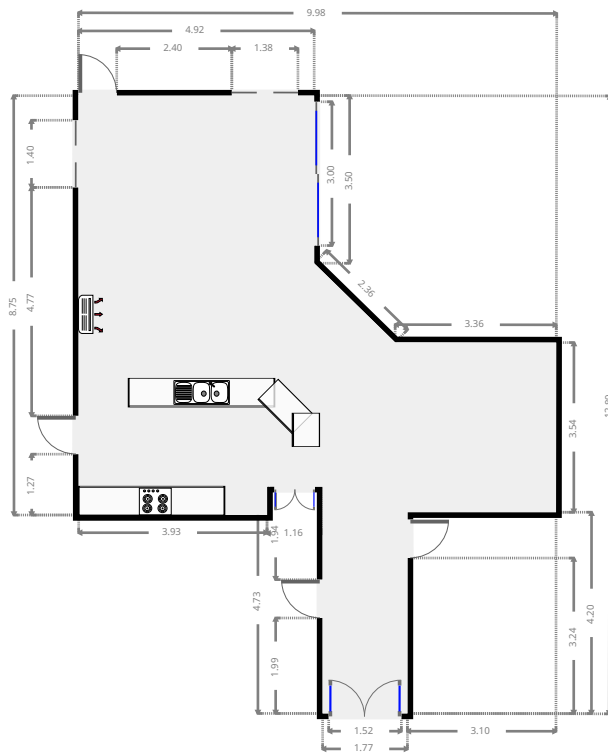
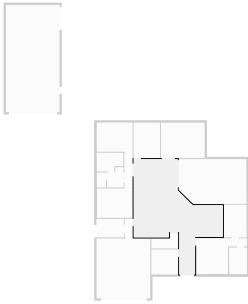

▼ Garage Ground Floor

WIDTH: 6.00 m • LENGTH: 6.70 m
AREA: 40.21 m² • PERIMETER: 25.40 m

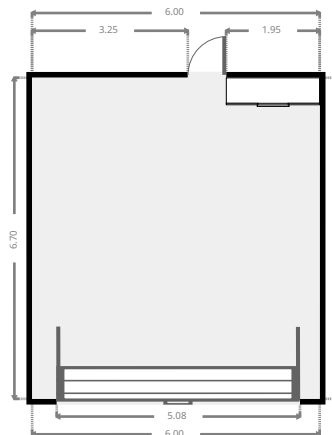
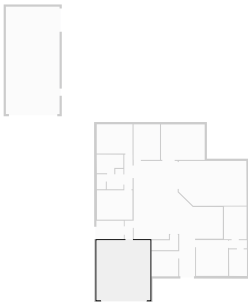

THIS FLOORPLAN IS PROVIDED WITHOUT WARRANTY OF ANY KIND. SENSOPIA DISCLAIMS ANY WARRANTY INCLUDING, WITHOUT LIMITATION, SATISFACTORY QUALITY OR ACCURACY OF DIMENSIONS.

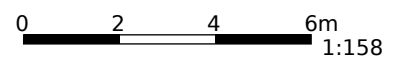

FLOORS: 1

▼ **Laundry Room**
Ground Floor

WIDTH: 3.06 m • LENGTH: 2.06 m
AREA: 6.30 m² • PERIMETER: 10.24 m

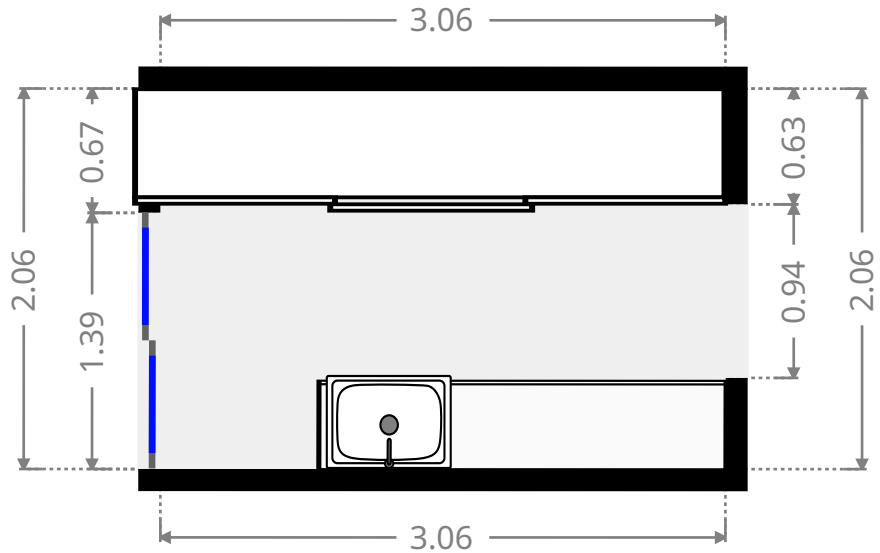

▼ **Closet**
Ground Floor

WIDTH: 0.91 m • LENGTH: 2.07 m
AREA: 1.88 m² • PERIMETER: 5.96 m

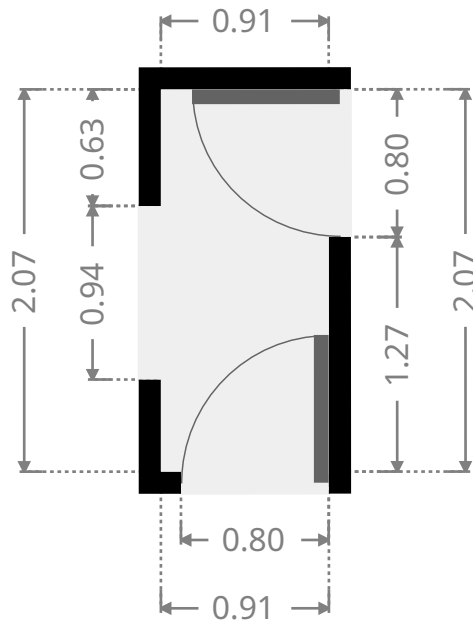

FLOORS: 1

▼ **Bathroom**
Ground Floor

WIDTH: 2.52 m • **LENGTH:** 3.65 m
AREA: 9.19 m² • **PERIMETER:** 12.34 m

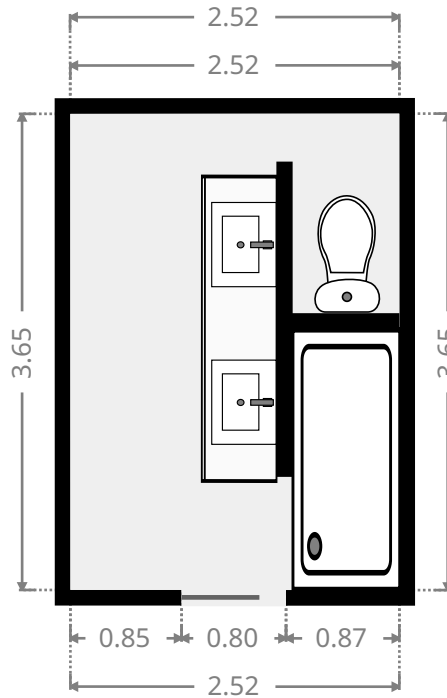

▼ **Closet**
Ground Floor

WIDTH: 2.02 m • **LENGTH:** 2.98 m
AREA: 5.92 m² • **PERIMETER:** 9.93 m

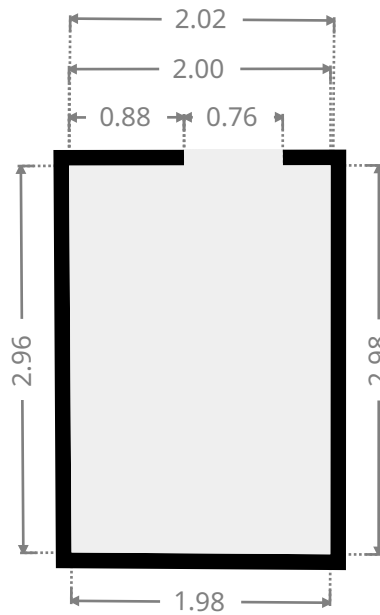

FLOORS: 1

▼ **Closet**
Ground Floor

WIDTH: 2.00 m • **LENGTH:** 0.91 m
AREA: 1.82 m² • **PERIMETER:** 5.82 m

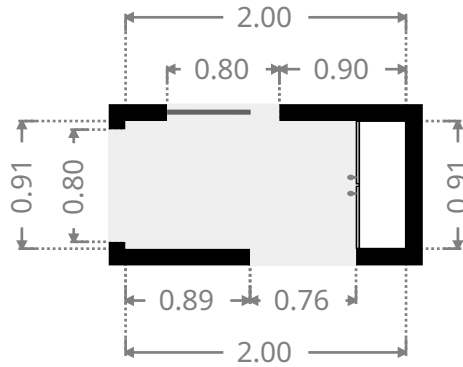
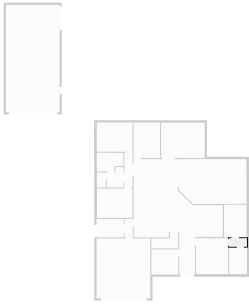

▼ **Master Bedroom**
Ground Floor

WIDTH: 3.58 m • **LENGTH:** 4.00 m
AREA: 14.32 m² • **PERIMETER:** 15.16 m

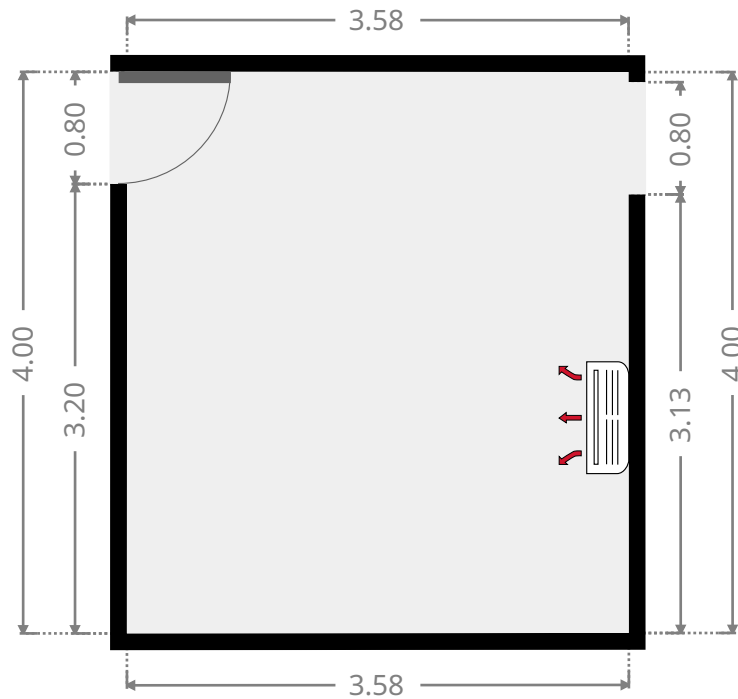
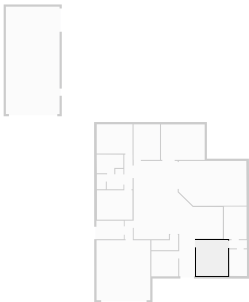

THIS FLOORPLAN IS PROVIDED WITHOUT WARRANTY OF ANY KIND. SENSOPIA DISCLAIMS ANY WARRANTY INCLUDING, WITHOUT LIMITATION, SATISFACTORY QUALITY OR ACCURACY OF DIMENSIONS.

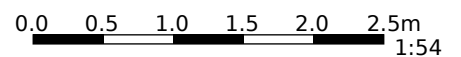

FLOORS: 1

▼ **Closet**
Ground Floor

WIDTH: 2.99 m • LENGTH: 1.70 m
AREA: 3.86 m² • PERIMETER: 9.38 m

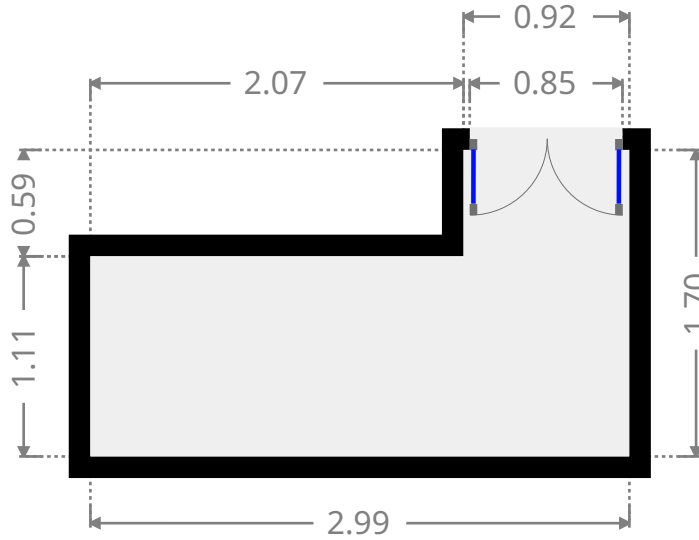

▼ **Study**
Ground Floor

WIDTH: 3.00 m • LENGTH: 2.80 m
AREA: 8.40 m² • PERIMETER: 11.60 m

