

10 Tippett Crescent

Created on
2021-02-11

Floors
1

▼ Ground Floor



▼ Hall Ground Floor

WIDTH: 1.48 m • LENGTH: 4.90 m
AREA: 7.25 m² • PERIMETER: 12.76 m

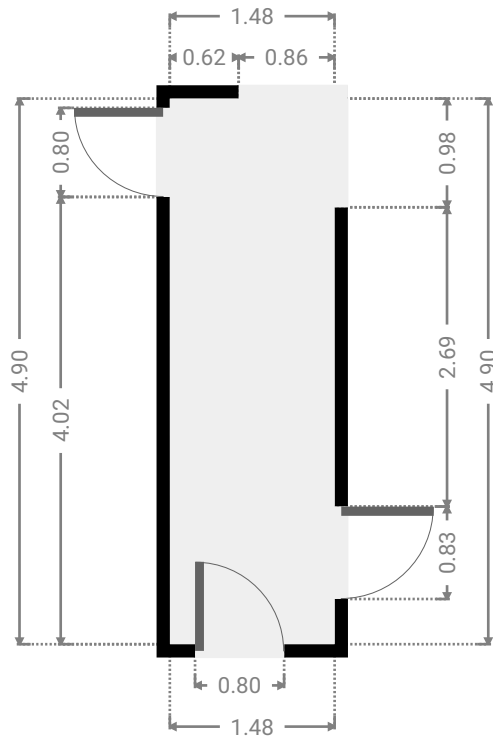
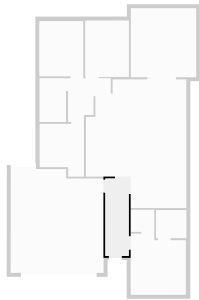

▼ Master Bedroom Ground Floor

WIDTH: 3.49 m • LENGTH: 3.87 m
AREA: 12.68 m² • PERIMETER: 14.72 m

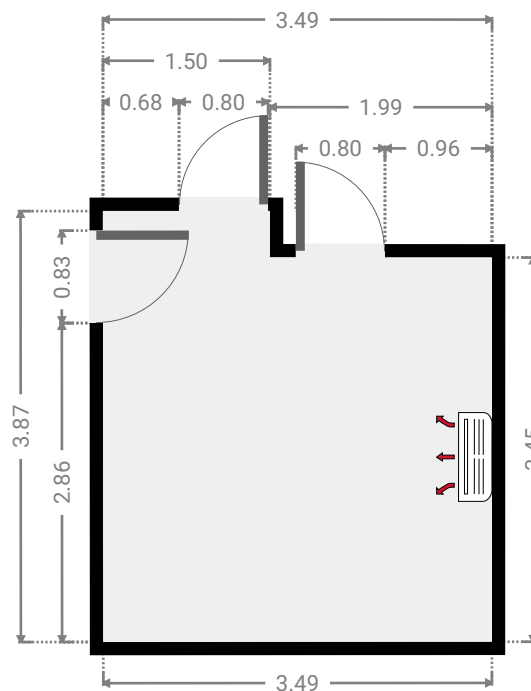
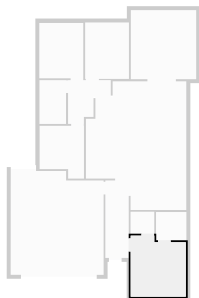

▼ Bathroom Ground Floor

WIDTH: 1.92 m • LENGTH: 1.78 m
AREA: 3.42 m² • PERIMETER: 7.40 m

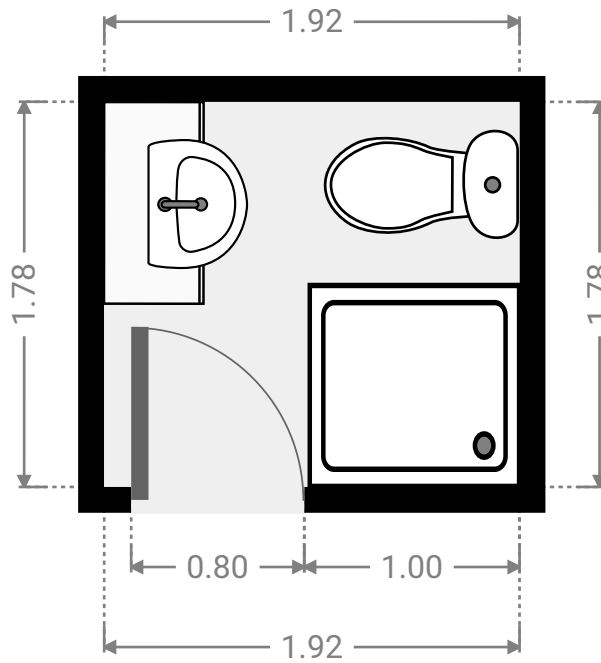
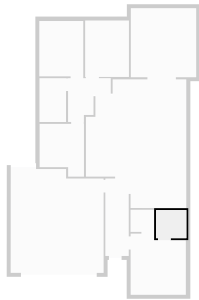

▼ Closet Ground Floor

WIDTH: 1.50 m • LENGTH: 1.40 m
AREA: 2.10 m² • PERIMETER: 5.80 m

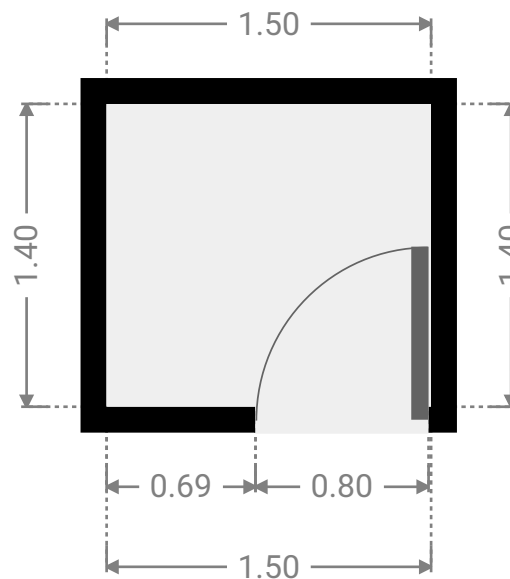
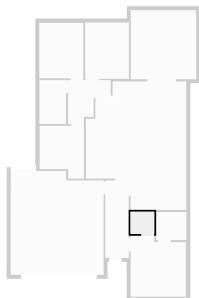

▼ Kitchen Ground Floor

WIDTH: 6.35 m • LENGTH: 8.14 m
AREA: 43.53 m² • PERIMETER: 28.98 m

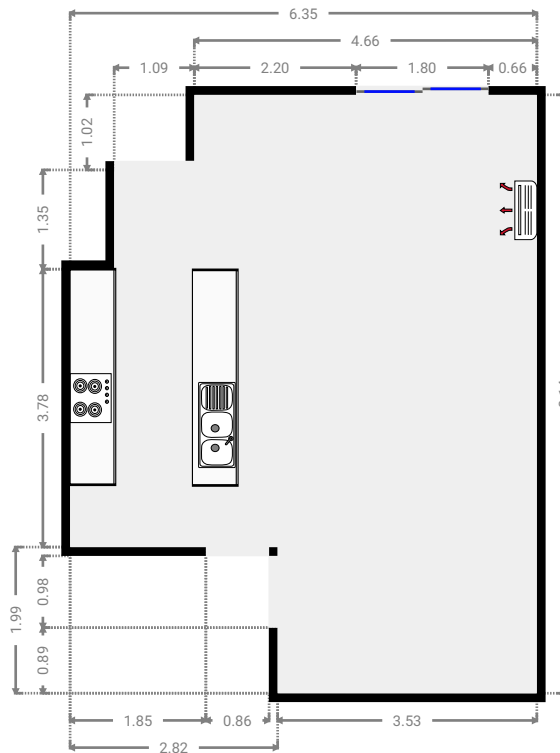
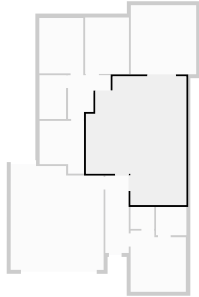

▼ Hall Ground Floor

WIDTH: 2.70 m • LENGTH: 2.77 m
AREA: 5.30 m² • PERIMETER: 10.94 m

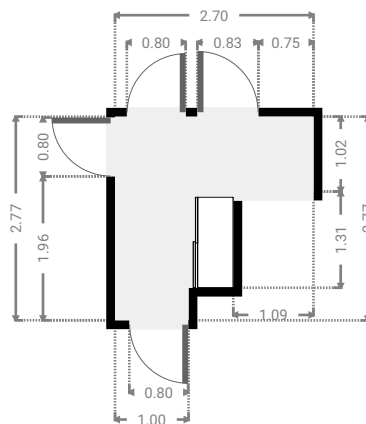
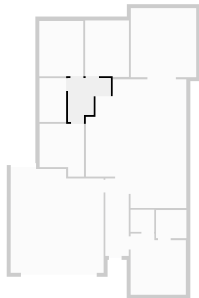

▼ Bedroom Ground Floor

WIDTH: 2.77 m • LENGTH: 3.57 m
AREA: 9.89 m² • PERIMETER: 12.68 m

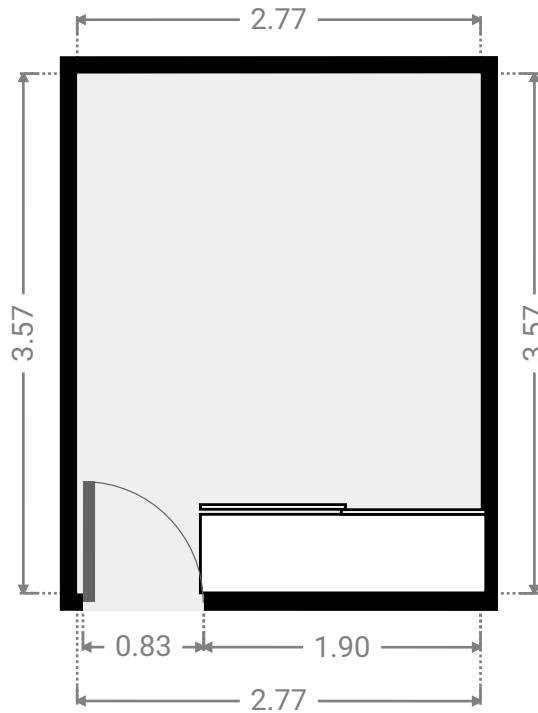
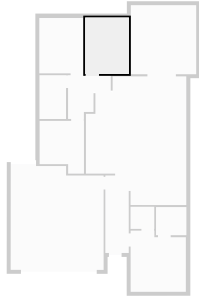

▼ Bedroom Ground Floor

WIDTH: 2.78 m • LENGTH: 3.50 m
AREA: 9.73 m² • PERIMETER: 12.56 m

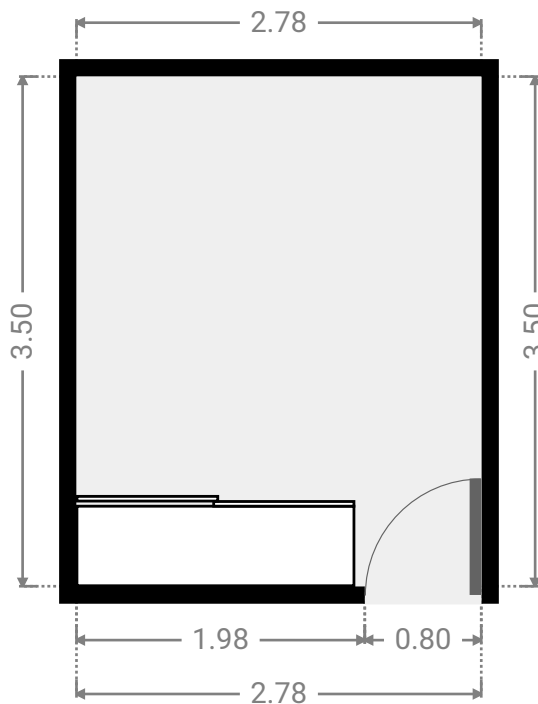
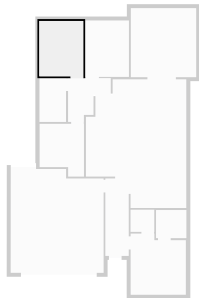

▼ Bedroom Ground Floor

WIDTH: 1.68 m • LENGTH: 2.77 m
AREA: 4.65 m² • PERIMETER: 8.90 m

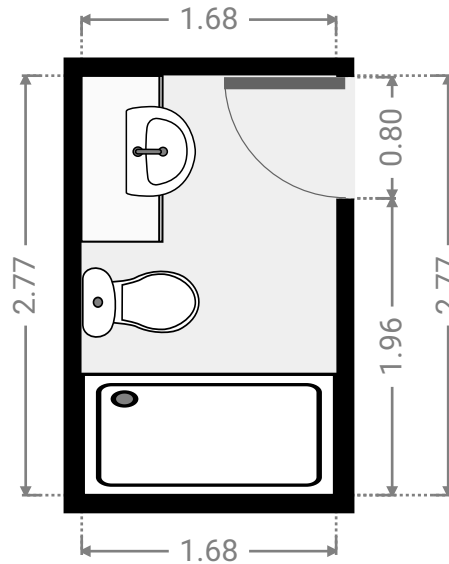
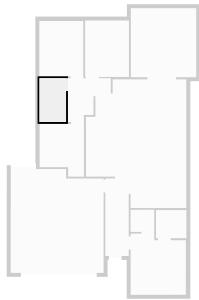

▼ Bedroom Ground Floor

WIDTH: 2.80 m • LENGTH: 3.34 m
AREA: 8.27 m² • PERIMETER: 12.28 m

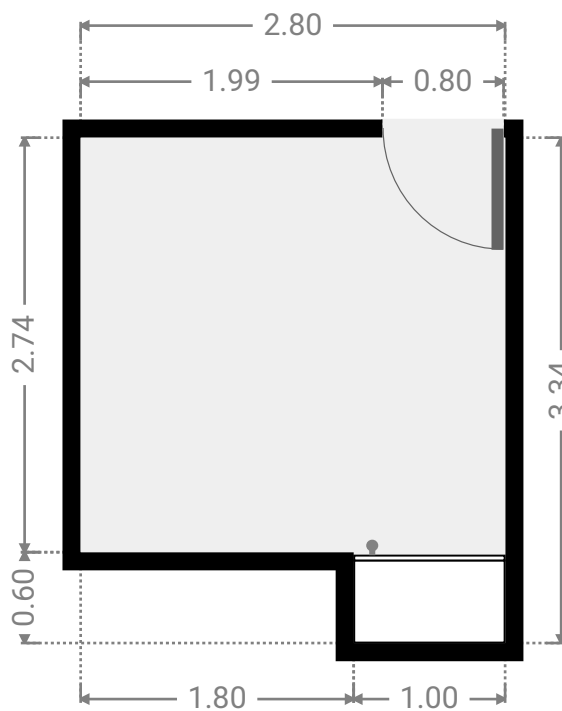
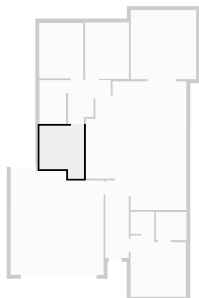

▼ Other Ground Floor

WIDTH: 4.13 m • LENGTH: 4.37 m
AREA: 18.05 m² • PERIMETER: 17.00 m

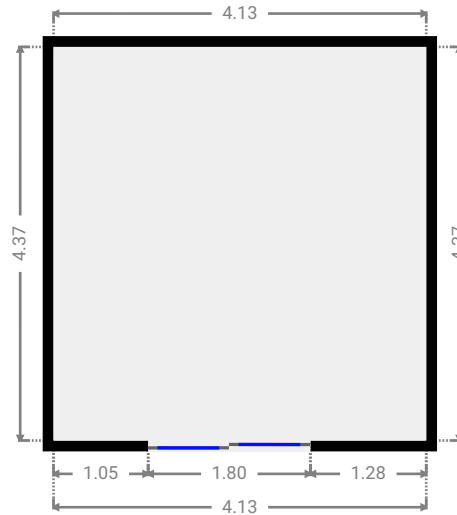
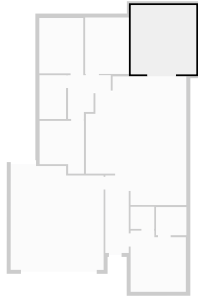

▼ Garage Ground Floor

WIDTH: 5.88 m • LENGTH: 6.57 m
AREA: 37.18 m² • PERIMETER: 24.89 m

