

10 Rosewood Avenue

SUBMITTED BY

Ray White Rockhampton Casey
stockers@cqoz.com

CREATED ON

2022-04-04

Floors

1

FLOORS: 1

▼ Ground Floor

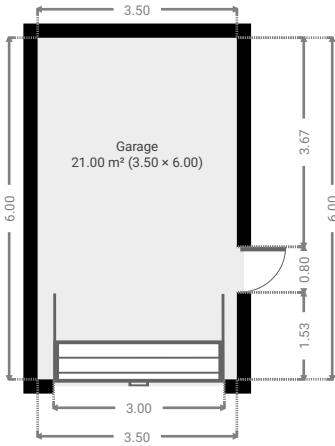

THIS FLOORPLAN IS PROVIDED WITHOUT WARRANTY OF ANY KIND. SENSOPIA DISCLAIMS ANY WARRANTY INCLUDING, WITHOUT LIMITATION, SATISFACTORY QUALITY OR ACCURACY OF DIMENSIONS.



FLOORS: 1

▼ **Bedroom**
Ground Floor

WIDTH: 3.26 m • LENGTH: 2.97 m
AREA: 8.14 m² • PERIMETER: 11.90 m

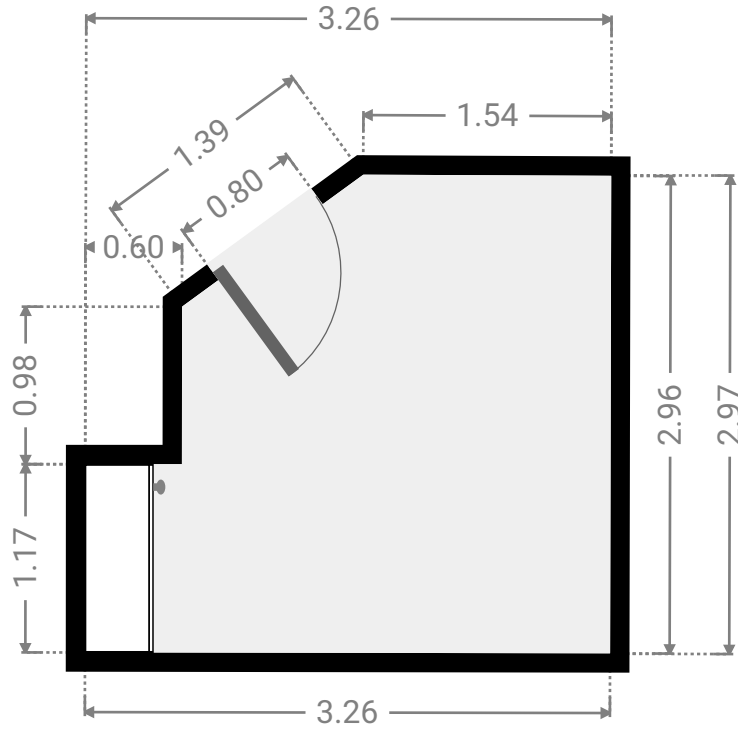
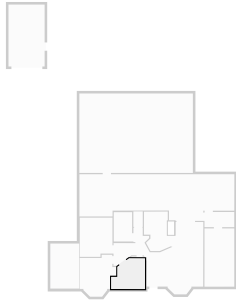

▼ **Other**
Ground Floor

WIDTH: 2.30 m • LENGTH: 0.64 m
AREA: 1.11 m² • PERIMETER: 5.19 m

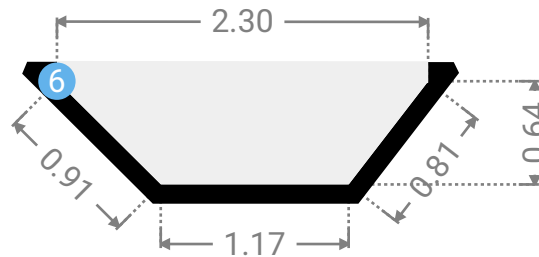
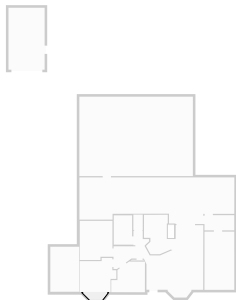

▼ **Other**/Ground Floor

6 **OPENING**

Height
0.00 m



FLOORS: 1

▼ **Garage**
Ground Floor

WIDTH: 2.80 m • LENGTH: 4.36 m
AREA: 12.21 m² • PERIMETER: 14.32 m

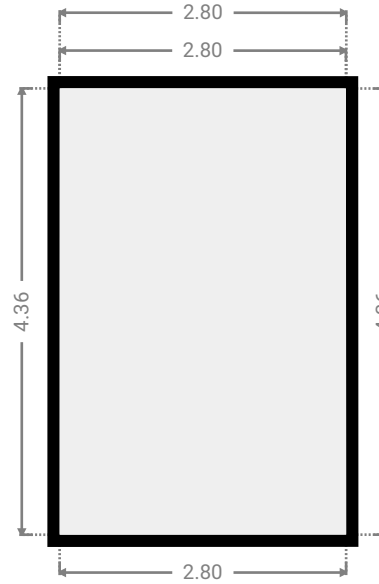
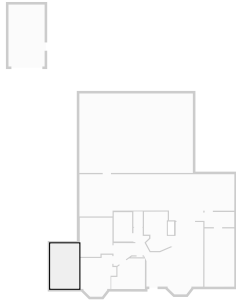

▼ **Garage**
Ground Floor

WIDTH: 3.50 m • LENGTH: 6.00 m
AREA: 21.00 m² • PERIMETER: 19.00 m

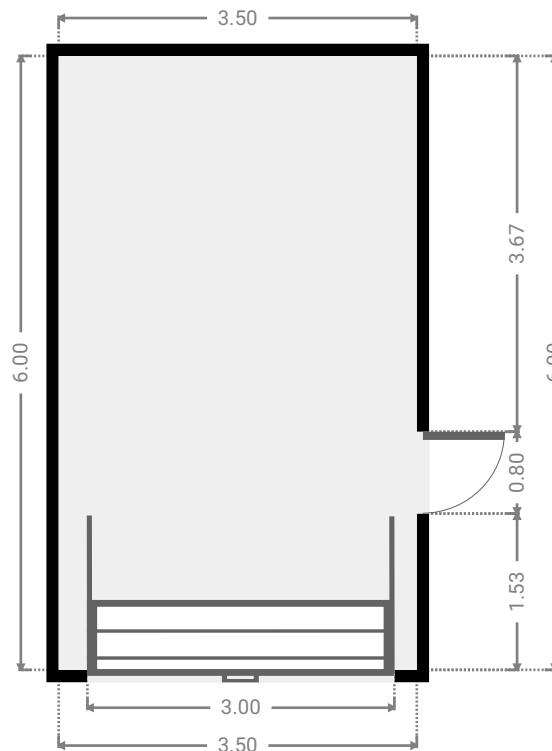
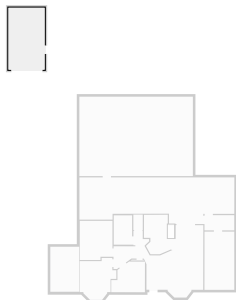

FLOORS: 1

▼ Other
Ground Floor

WIDTH: 11.00 m • LENGTH: 7.70 m
AREA: 84.70 m² • PERIMETER: 37.40 m

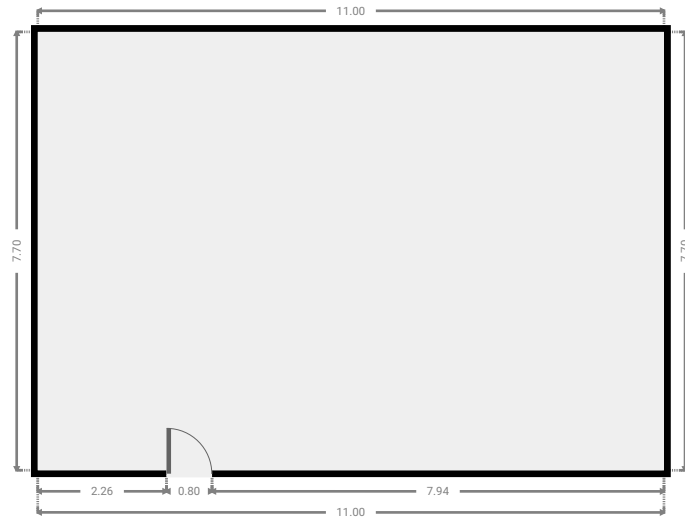
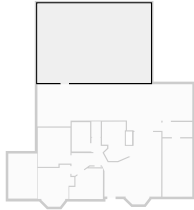

▼ Other
Ground Floor

WIDTH: 15.02 m • LENGTH: 4.53 m
AREA: 58.00 m² • PERIMETER: 40.20 m

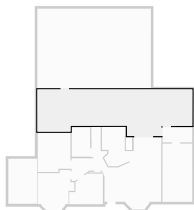

FLOORS: 1

▼ **Bedroom**
Ground Floor

WIDTH: 2.89 m • LENGTH: 5.64 m
AREA: 16.28 m² • PERIMETER: 17.06 m

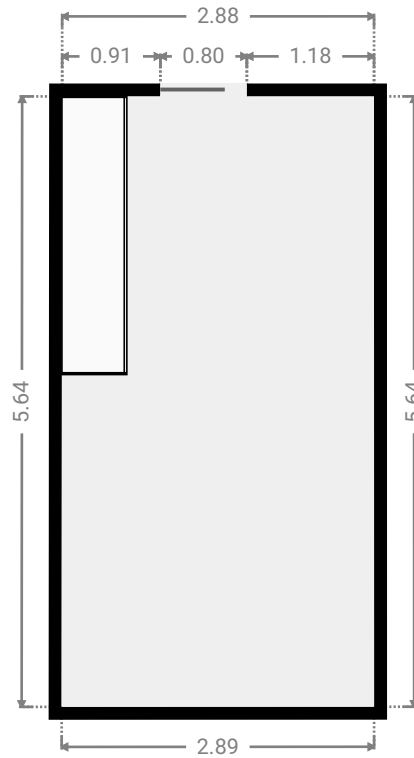
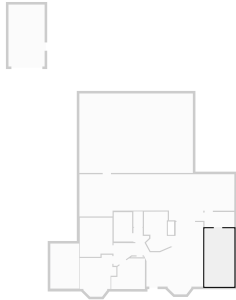

▼ **Laundry Room**
Ground Floor

WIDTH: 2.88 m • LENGTH: 1.47 m
AREA: 4.23 m² • PERIMETER: 8.70 m

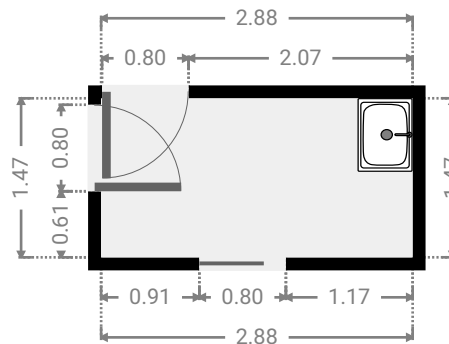
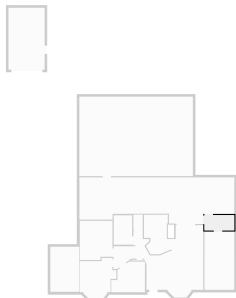

FLOORS: 1

▼ Closet
Ground Floor

WIDTH: 1.29 m • LENGTH: 0.07 m
AREA: 0.09 m² • PERIMETER: 2.63 m

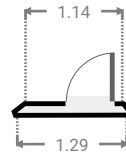
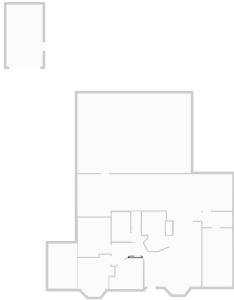

▼ Living Room
Ground Floor

WIDTH: 8.70 m • LENGTH: 6.26 m
AREA: 32.30 m² • PERIMETER: 32.03 m

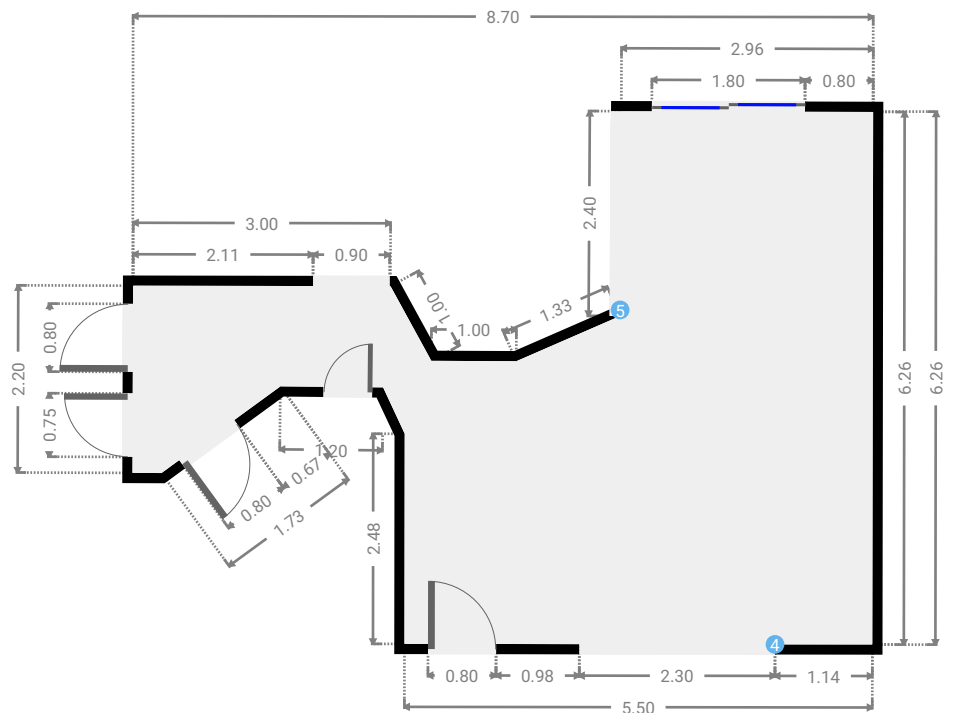
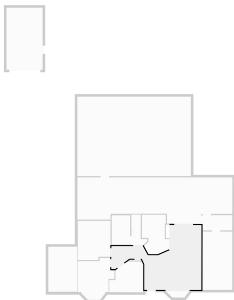

FLOORS: 1

▼ **Kitchen**
Ground Floor

WIDTH: 2.67 m • LENGTH: 3.83 m
AREA: 8.80 m² • PERIMETER: 12.88 m

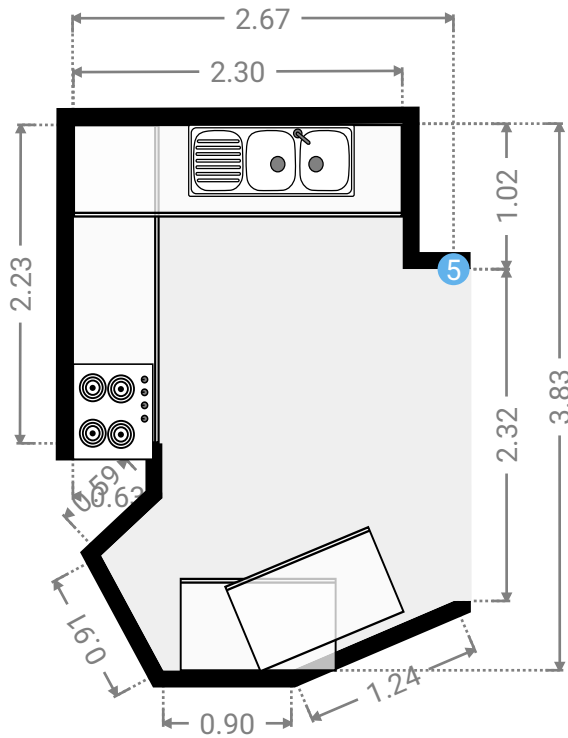
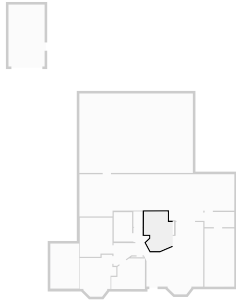

▼ **Kitchen/Ground Floor**

5 OPENING

Height
0.00 m



FLOORS: 1

▼ **Other**
Ground Floor

WIDTH: 2.30 m • LENGTH: 0.63 m
AREA: 1.10 m² • PERIMETER: 5.17 m

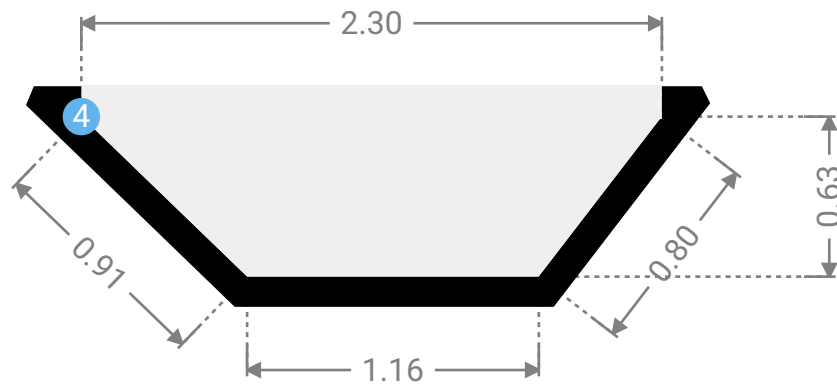
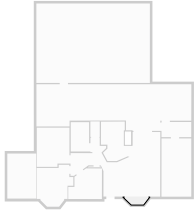

▼ **Other/Ground Floor**

4 OPENING

Height
0.00 m



FLOORS: 1

▼ Bedroom
Ground Floor

WIDTH: 3.55 m • LENGTH: 3.31 m
AREA: 9.90 m² • PERIMETER: 13.71 m

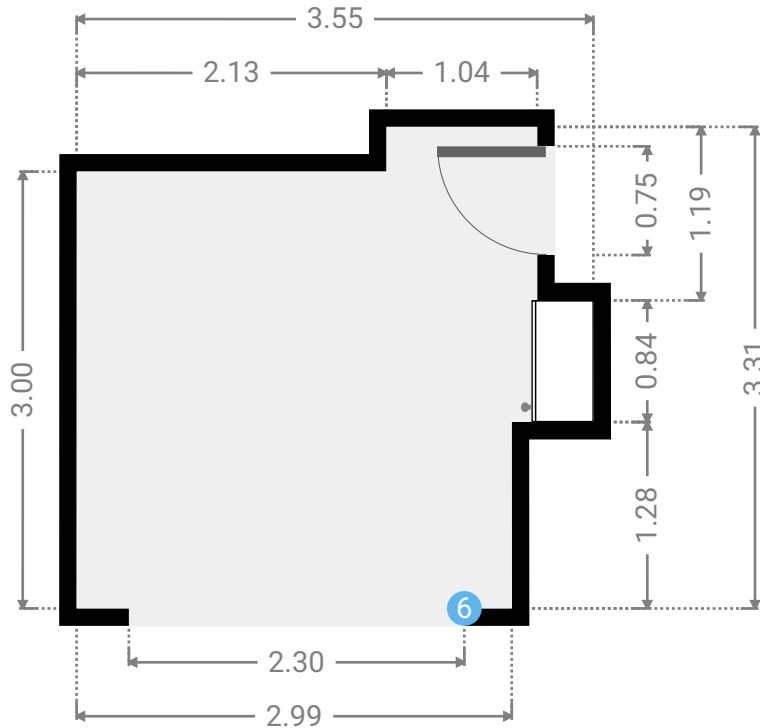
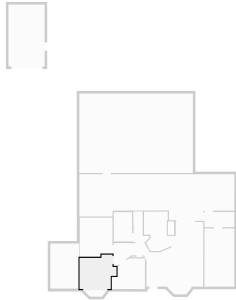

▼ Bedroom
Ground Floor

WIDTH: 3.16 m • LENGTH: 3.80 m
AREA: 11.65 m² • PERIMETER: 13.93 m

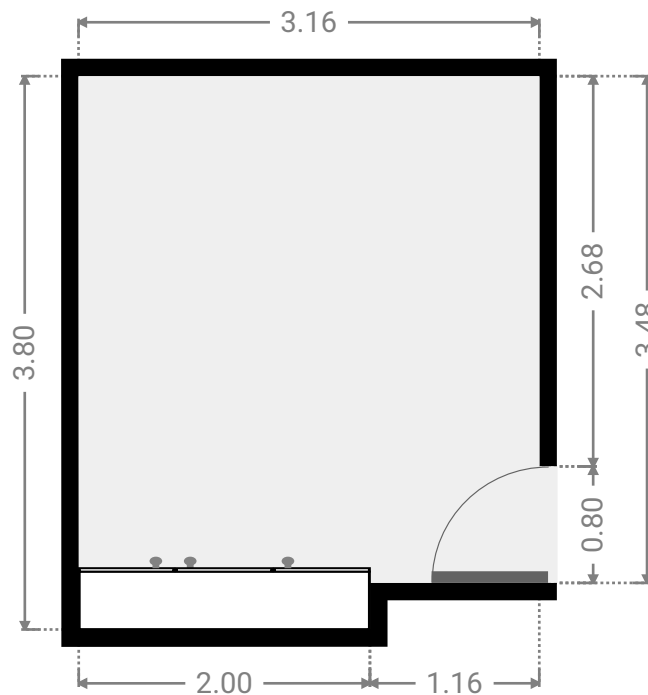
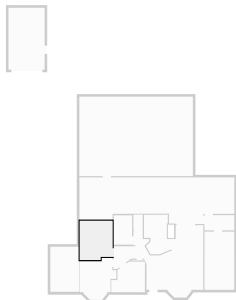

FLOORS: 1

▼ **Toilet**
Ground Floor

WIDTH: 0.91 m • LENGTH: 1.50 m
AREA: 1.36 m² • PERIMETER: 4.81 m

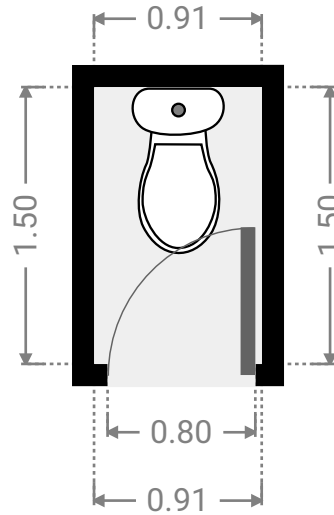
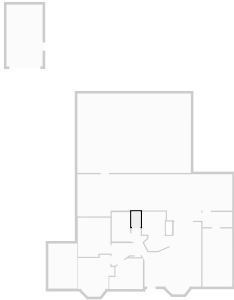

▼ **Bathroom**
Ground Floor

WIDTH: 1.78 m • LENGTH: 2.84 m
AREA: 5.06 m² • PERIMETER: 9.24 m

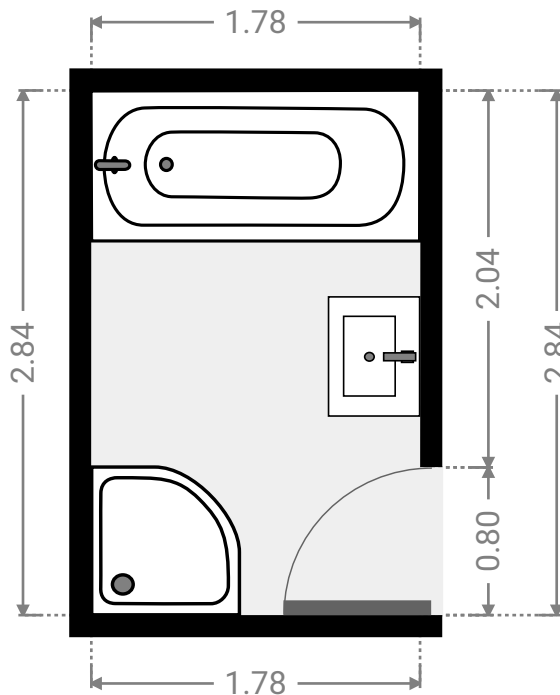
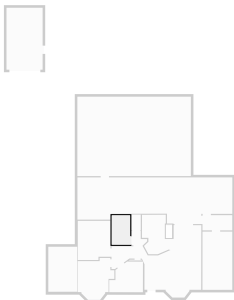

▼ **Hall**
Ground Floor

WIDTH: 1.52 m • LENGTH: 1.40 m
AREA: 1.55 m² • PERIMETER: 5.61 m

