

# 10 Retreat Avenue

## Ground Floor

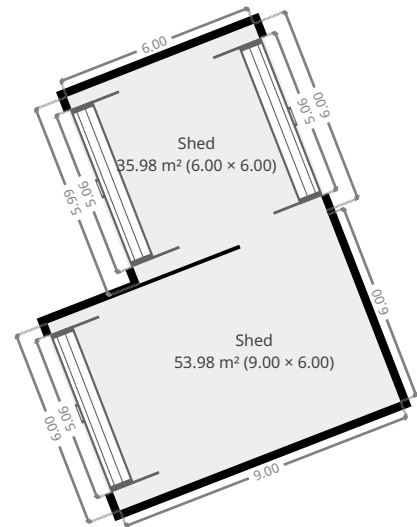

THIS FLOORPLAN IS PROVIDED WITHOUT WARRANTY OF ANY KIND. SENSOPIA DISCLAIMS ANY WARRANTY INCLUDING, WITHOUT LIMITATION, SATISFACTORY QUALITY OR ACCURACY OF DIMENSIONS.

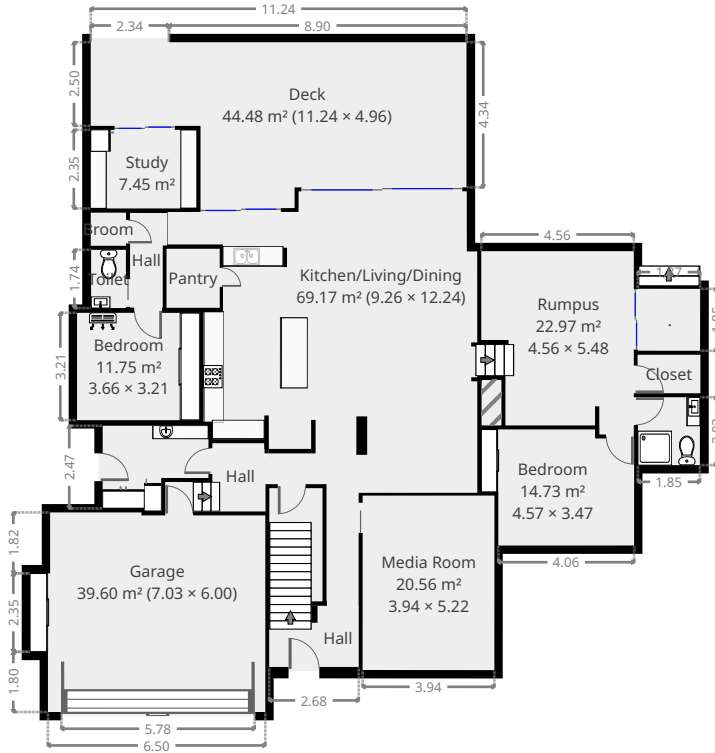
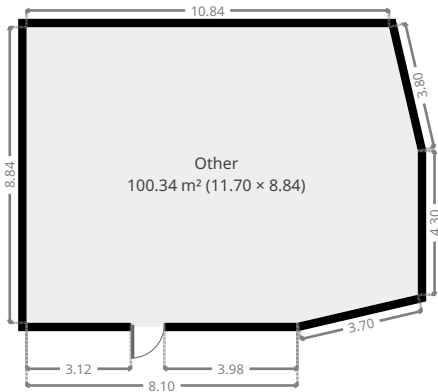

# 10 Retreat Avenue

## Bedroom

Width: 3.47 m  
 Length: 4.57 m  
 Area: 14.73 m<sup>2</sup>  
 Perimeter: 16.08 m

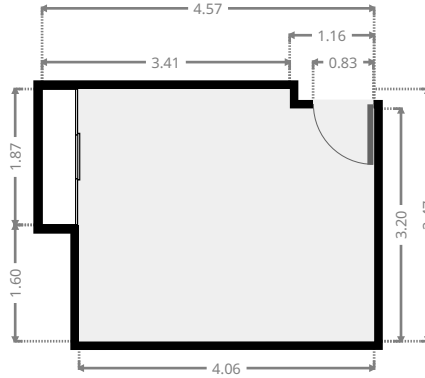
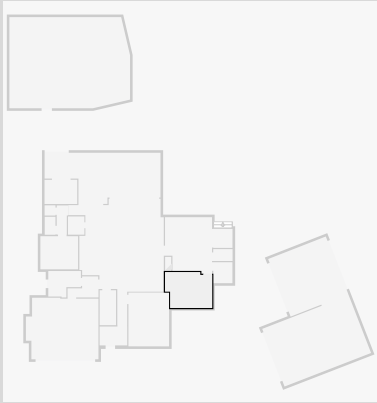

## Other

Width: 8.84 m  
 Length: 11.70 m  
 Area: 100.34 m<sup>2</sup>  
 Perimeter: 39.58 m

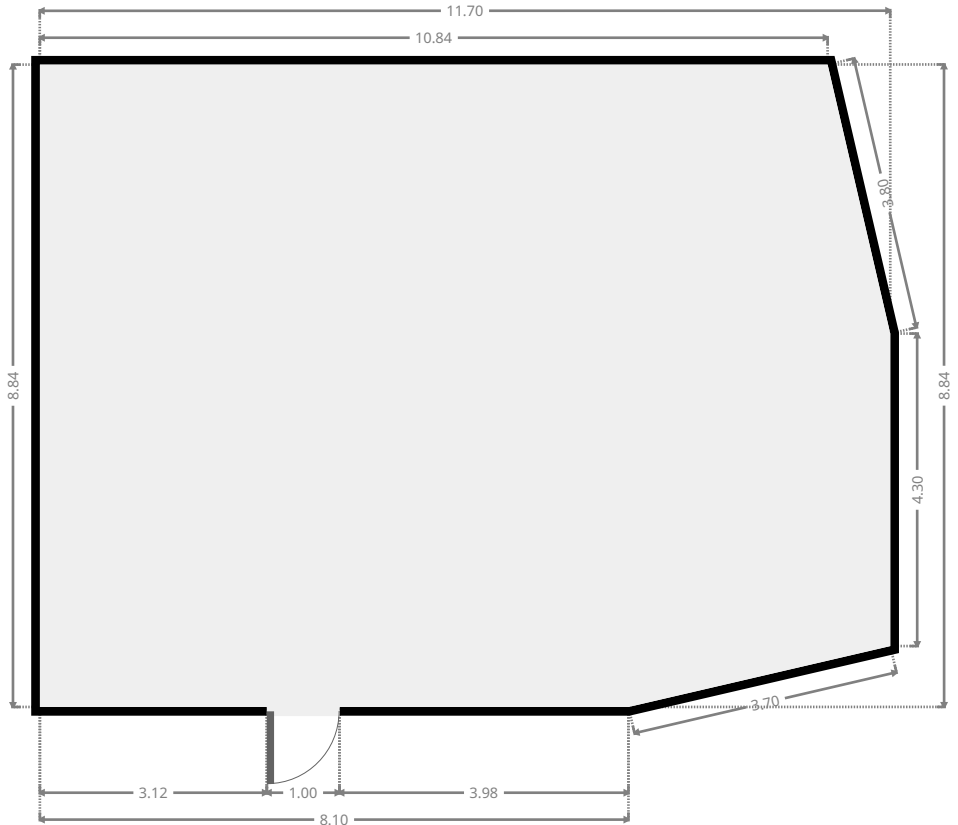
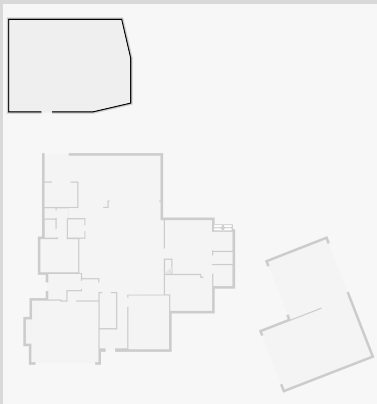

THIS FLOORPLAN IS PROVIDED WITHOUT WARRANTY OF ANY KIND. SENSOPIA DISCLAIMS ANY WARRANTY INCLUDING, WITHOUT LIMITATION, SATISFACTORY QUALITY OR ACCURACY OF DIMENSIONS.

# 10 Retreat Avenue

## Shed

Width: 6.00 m  
 Length: 9.00 m  
 Area: 53.98 m<sup>2</sup>  
 Perimeter: 30.00 m

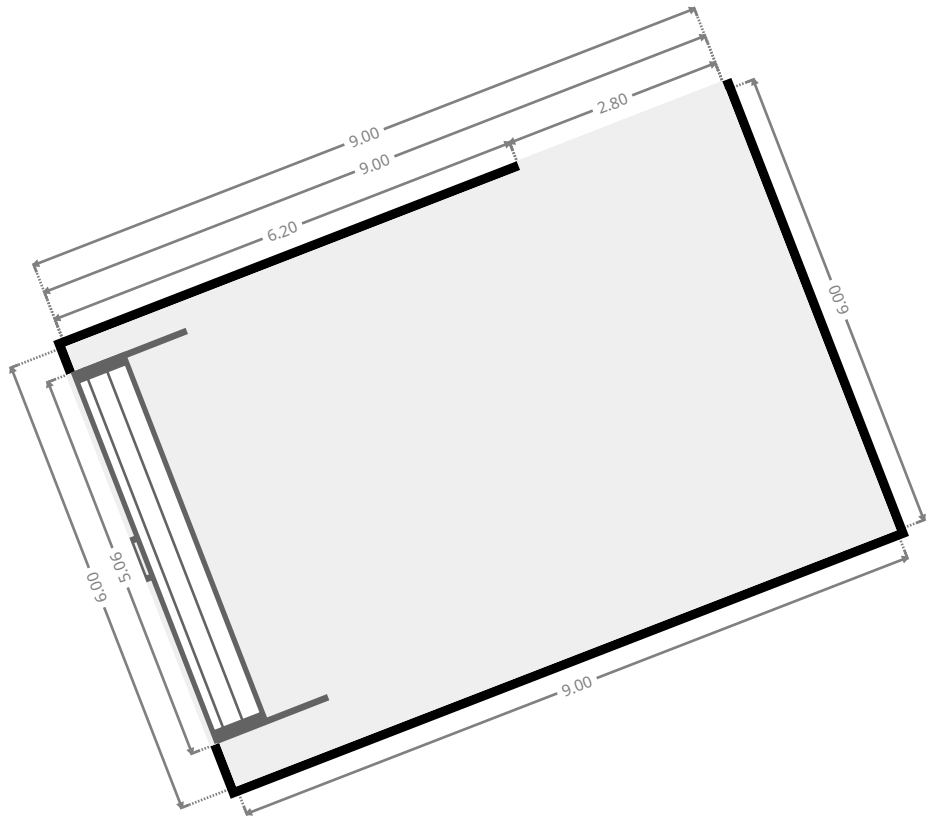
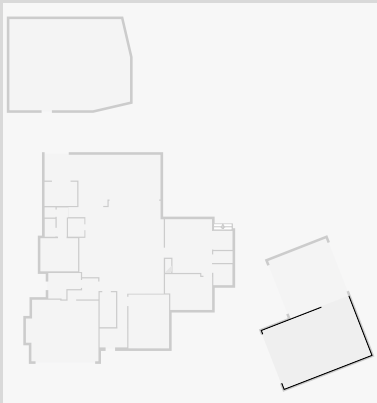

## Shed

Width: 6.00 m  
 Length: 6.00 m  
 Area: 35.98 m<sup>2</sup>  
 Perimeter: 23.99 m

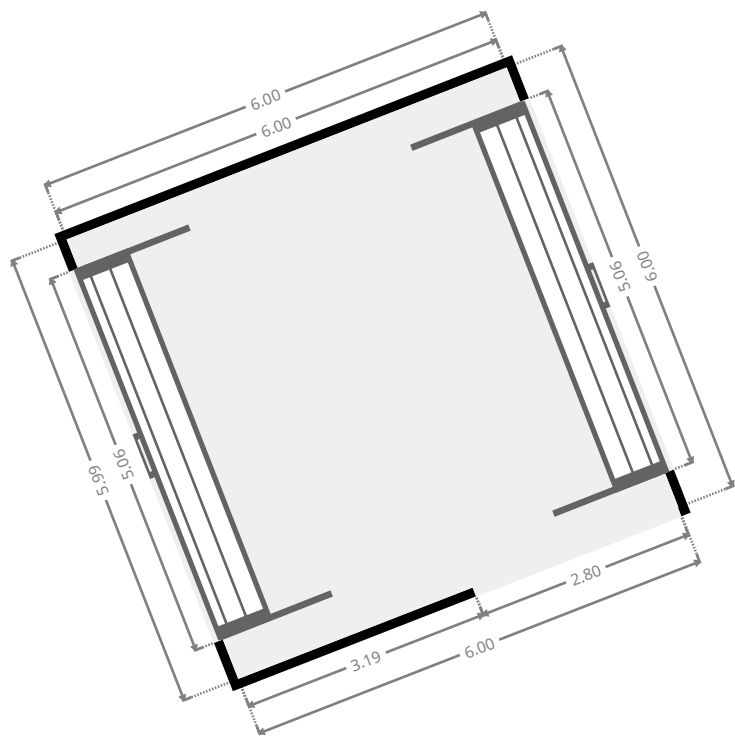
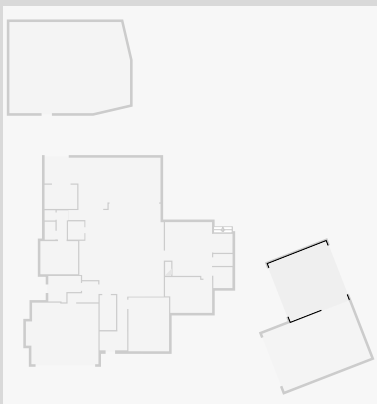

THIS FLOORPLAN IS PROVIDED WITHOUT WARRANTY OF ANY KIND. SENSOPIA DISCLAIMS ANY WARRANTY INCLUDING, WITHOUT LIMITATION, SATISFACTORY QUALITY OR ACCURACY OF DIMENSIONS.



# 10 Retreat Avenue

## Deck

Width: 4.96 m  
Length: 11.24 m  
Area: 44.48 m<sup>2</sup>  
Perimeter: 32.40 m

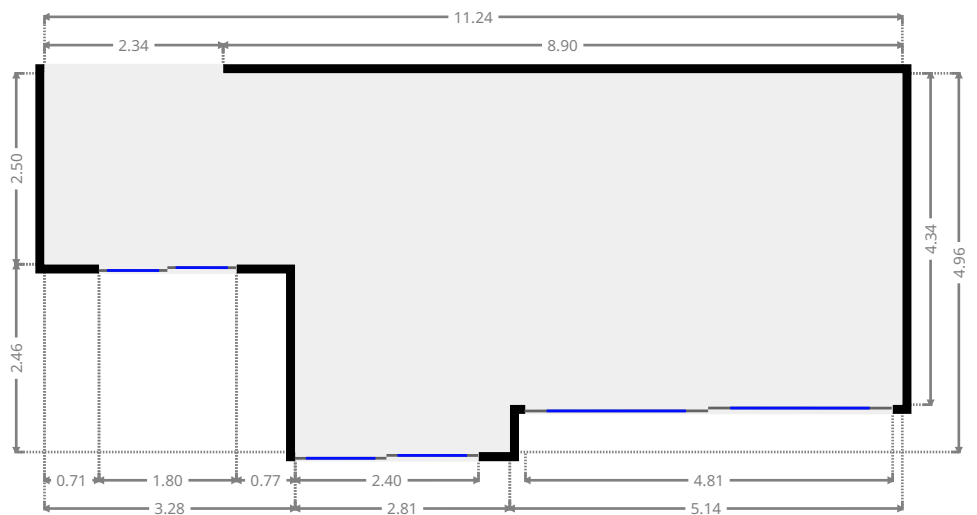
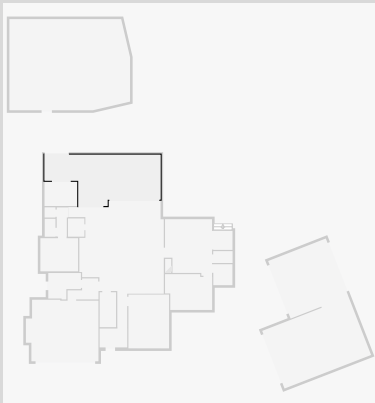

THIS FLOORPLAN IS PROVIDED WITHOUT WARRANTY OF ANY KIND. SENSOPIA DISCLAIMS ANY WARRANTY INCLUDING, WITHOUT LIMITATION, SATISFACTORY QUALITY OR ACCURACY OF DIMENSIONS.

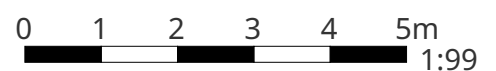

# 10 Retreat Avenue

## Study

Width: 2.35 m  
Length: 3.17 m  
Area: 7.45 m<sup>2</sup>  
Perimeter: 11.04 m

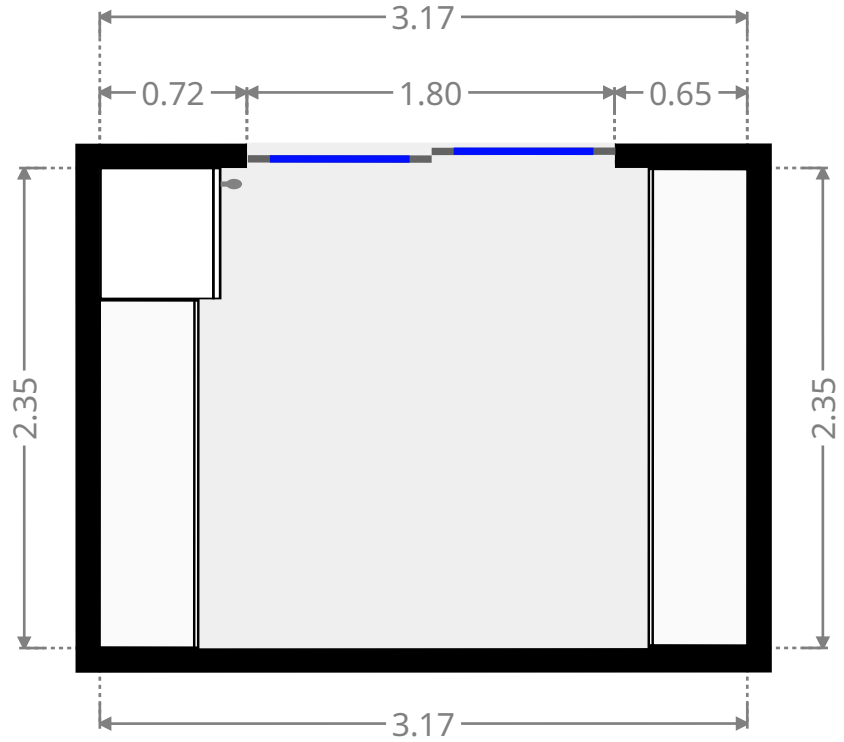
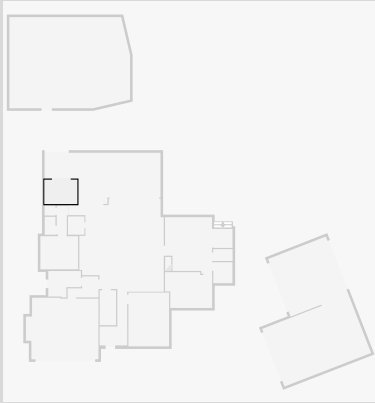

## Broom

Width: 0.99 m  
Length: 1.05 m  
Area: 1.05 m<sup>2</sup>  
Perimeter: 4.09 m

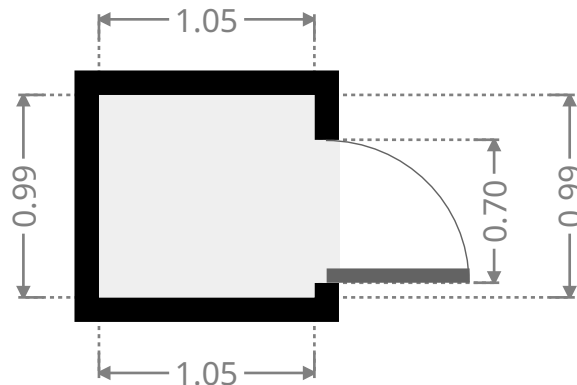

# 10 Retreat Avenue

## Toilet / Half Bath

Width: 1.04 m  
Length: 1.74 m  
Area: 1.81 m<sup>2</sup>  
Perimeter: 5.56 m

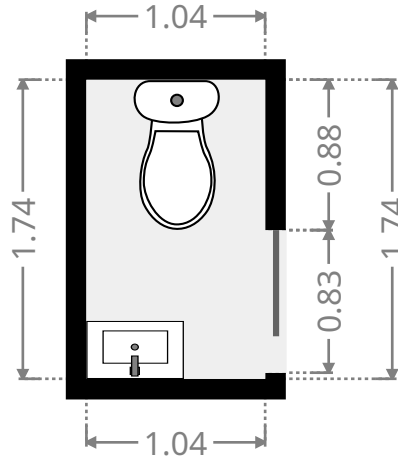
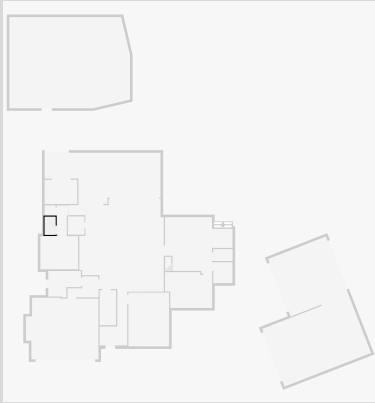

## Bedroom

Width: 3.21 m  
Length: 3.66 m  
Area: 11.75 m<sup>2</sup>  
Perimeter: 13.74 m

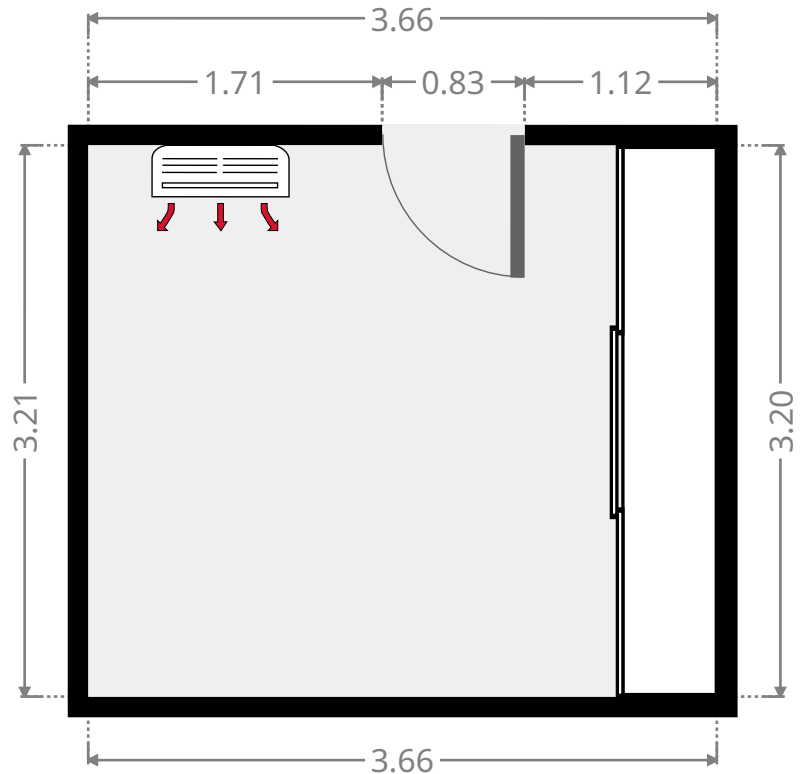
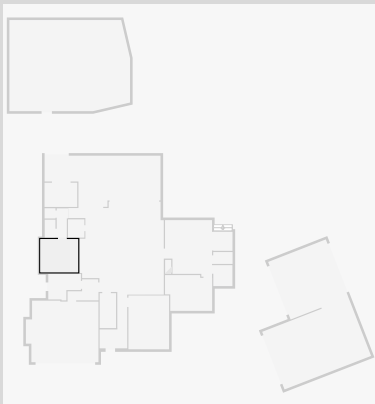

# 10 Retreat Avenue

## Hall

Width: 0.98 m  
 Length: 2.83 m  
 Area: 2.77 m<sup>2</sup>  
 Perimeter: 7.61 m

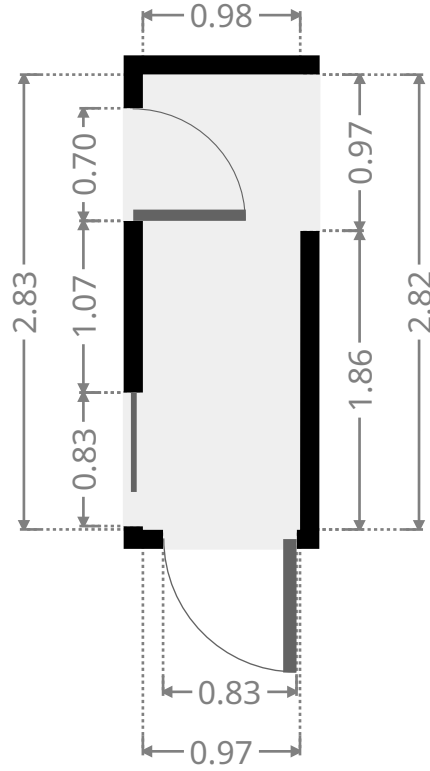
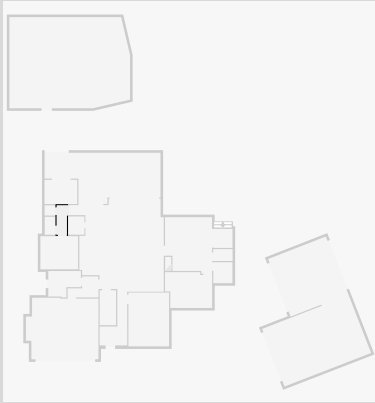

Width: 1.85 m  
 Length: 1.87 m  
 Area: 3.45 m<sup>2</sup>  
 Perimeter: 7.43 m

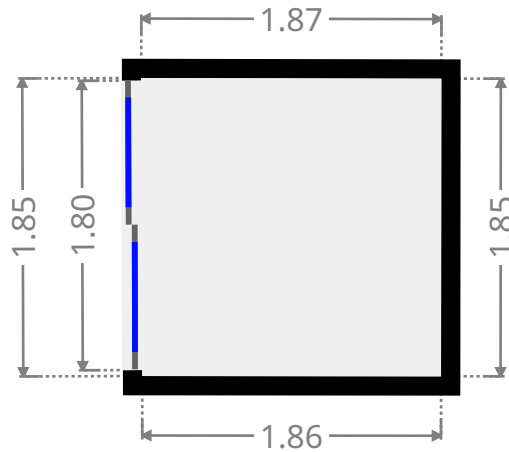

# 10 Retreat Avenue

## Hall

Width: 1.83 m  
 Length: 2.68 m  
 Area: 4.90 m<sup>2</sup>  
 Perimeter: 9.02 m

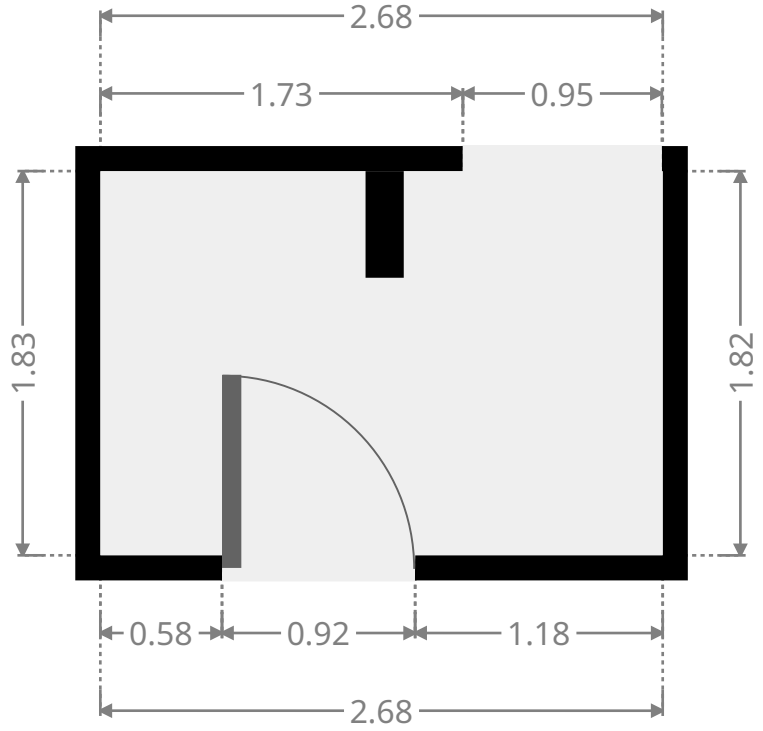
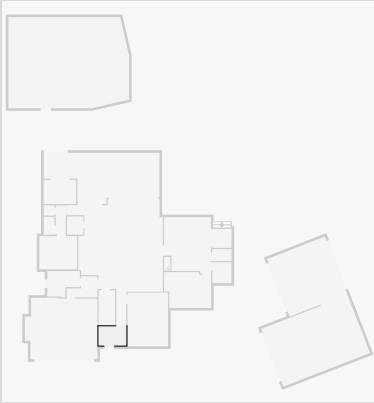

## Bathroom

Width: 1.85 m  
 Length: 2.03 m  
 Area: 3.76 m<sup>2</sup>  
 Perimeter: 7.77 m

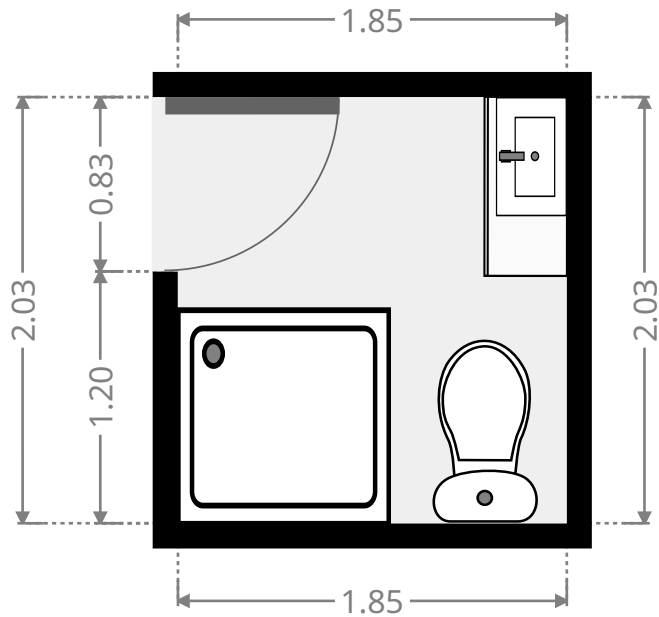
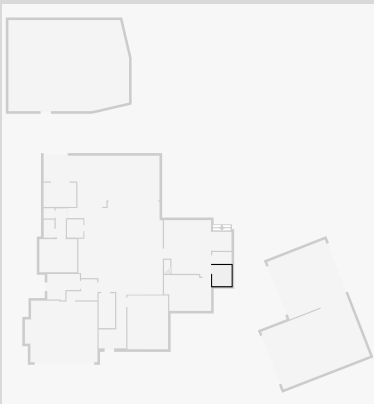

THIS FLOORPLAN IS PROVIDED WITHOUT WARRANTY OF ANY KIND. SENSOPIA DISCLAIMS ANY WARRANTY INCLUDING, WITHOUT LIMITATION, SATISFACTORY QUALITY OR ACCURACY OF DIMENSIONS.

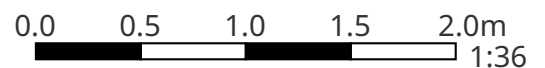



# 10 Retreat Avenue

## Closet

Width:	1.15 m
Length:	1.88 m
Area	2.16 m <sup>2</sup>
Perimeter	6.05 m

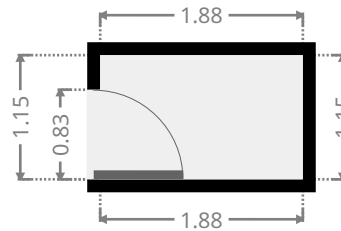

## Rumpus

Width:	4.56 m
Length:	5.48 m
Area	22.97 m <sup>2</sup>
Perimeter	20.08 m

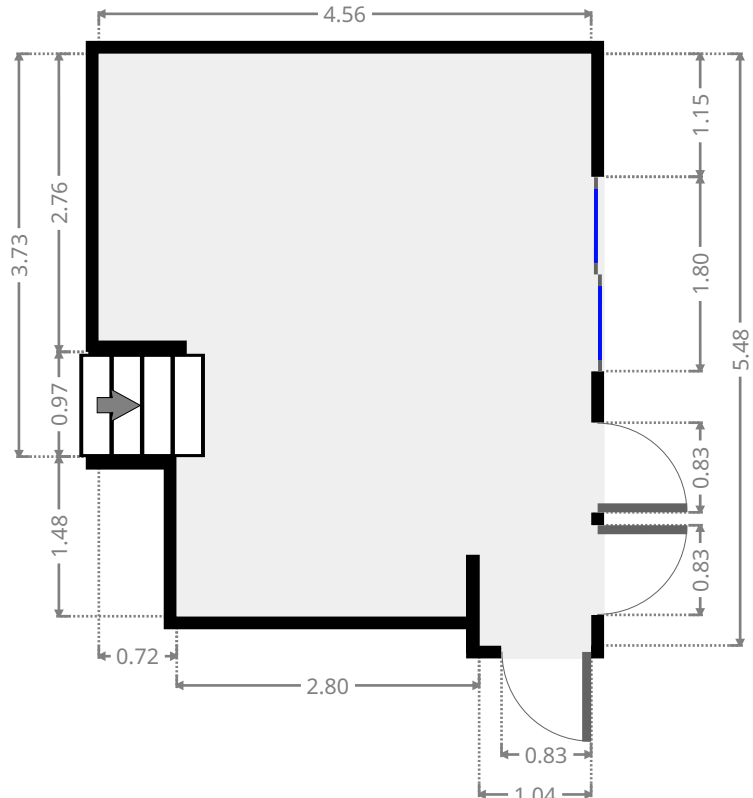

THIS FLOORPLAN IS PROVIDED WITHOUT WARRANTY OF ANY KIND. SENSOPIA DISCLAIMS ANY WARRANTY INCLUDING, WITHOUT LIMITATION, SATISFACTORY QUALITY OR ACCURACY OF DIMENSIONS.

# 10 Retreat Avenue

## Media Room

Width: 3.94 m  
Length: 5.22 m  
Area: 20.56 m<sup>2</sup>  
Perimeter: 18.32 m

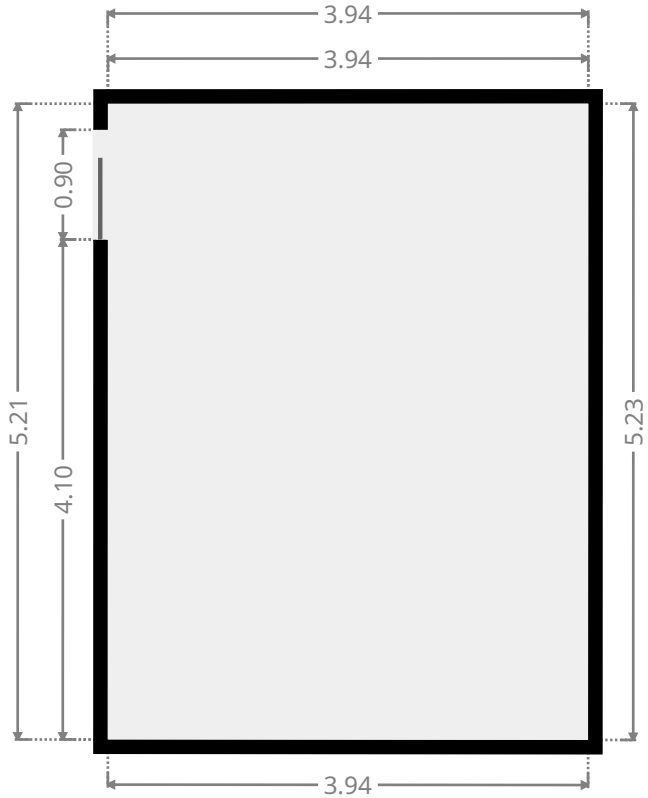
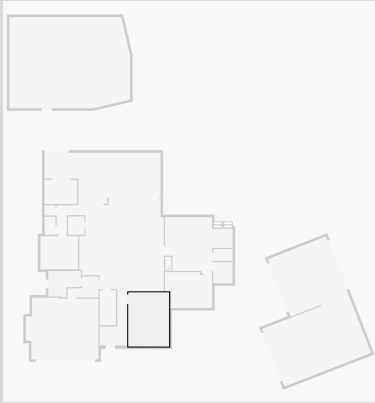

## Stairway

Width: 1.59 m  
Length: 3.38 m  
Area: 5.38 m<sup>2</sup>  
Perimeter: 9.95 m

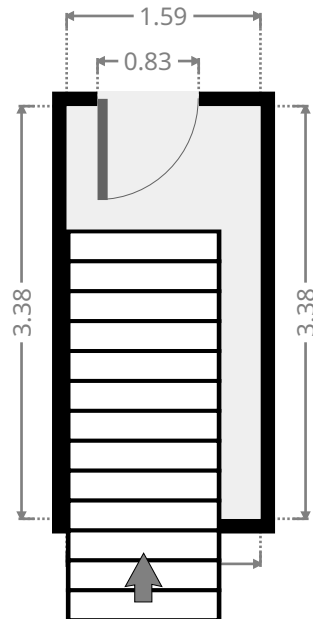
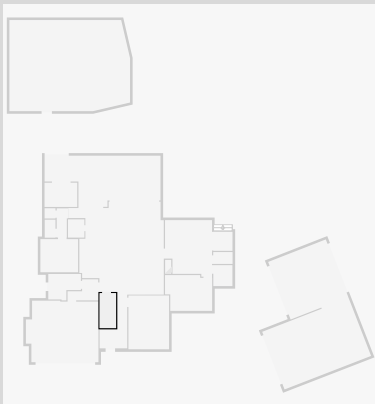

# 10 Retreat Avenue

## Garage

Width: 6.00 m  
 Length: 7.03 m  
 Area: 39.60 m<sup>2</sup>  
 Perimeter: 26.00 m

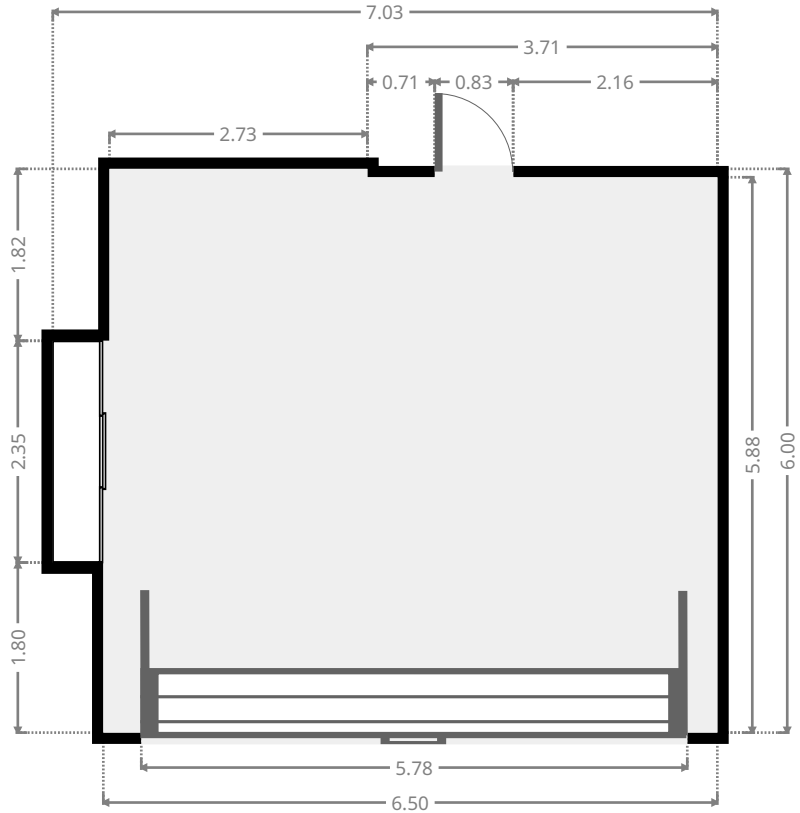
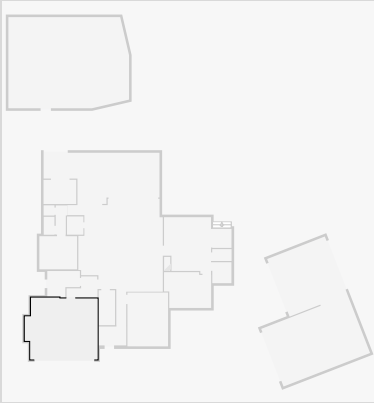

## Laundry Room

Width: 2.56 m  
 Length: 3.16 m  
 Area: 6.57 m<sup>2</sup>  
 Perimeter: 11.45 m

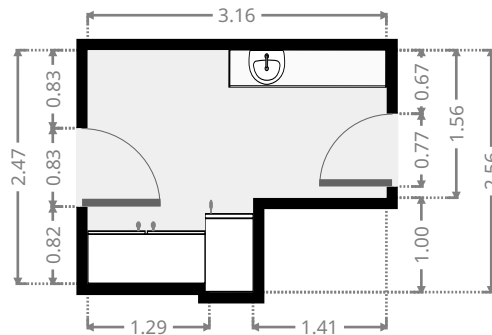
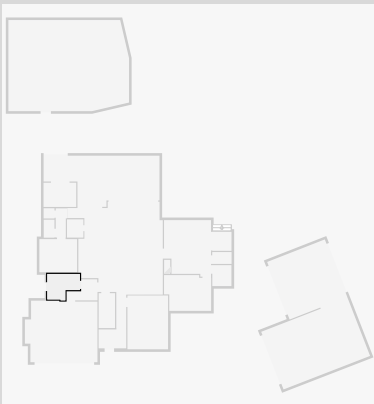

# 10 Retreat Avenue

## Hall

Width: 2.04 m  
 Length: 4.71 m  
 Area: 5.83 m<sup>2</sup>  
 Perimeter: 13.49 m

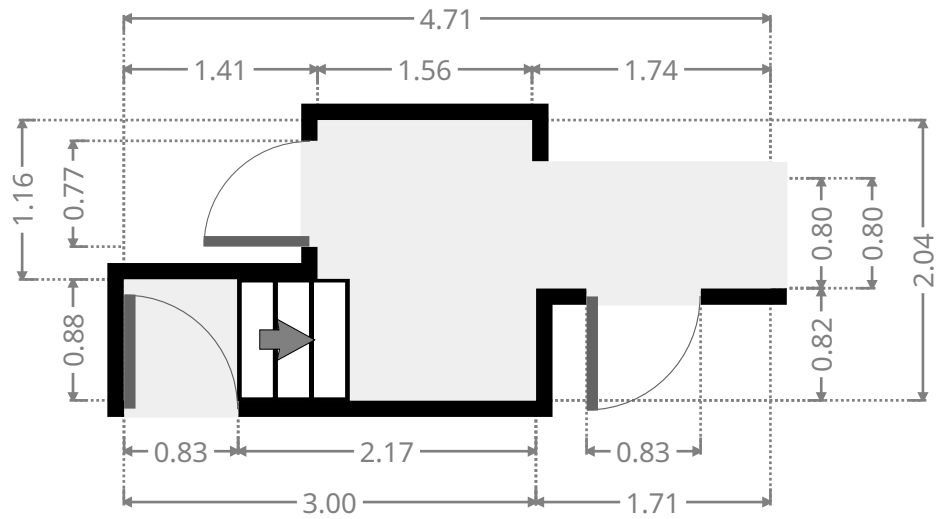
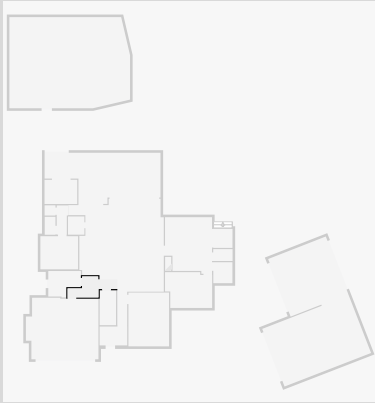

## Pantry

Width: 1.59 m  
 Length: 1.76 m  
 Area: 2.81 m<sup>2</sup>  
 Perimeter: 6.71 m

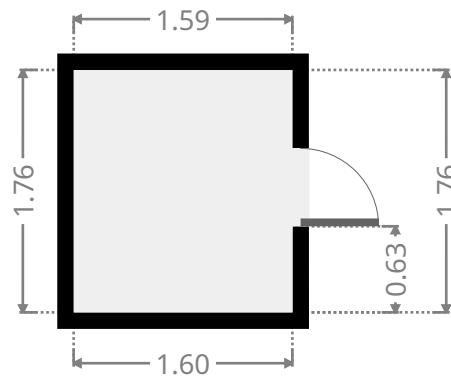
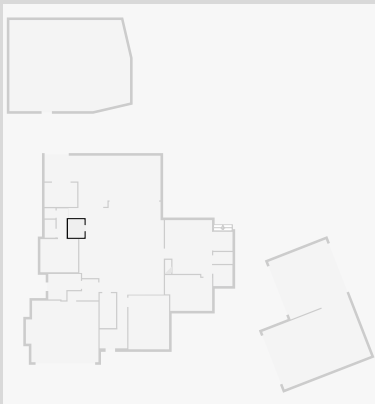

# 10 Retreat Avenue

## Kitchen/Living/Dining

Width: 9.26 m  
 Length: 12.24 m  
 Area: 69.17 m<sup>2</sup>  
 Perimeter: 44.16 m

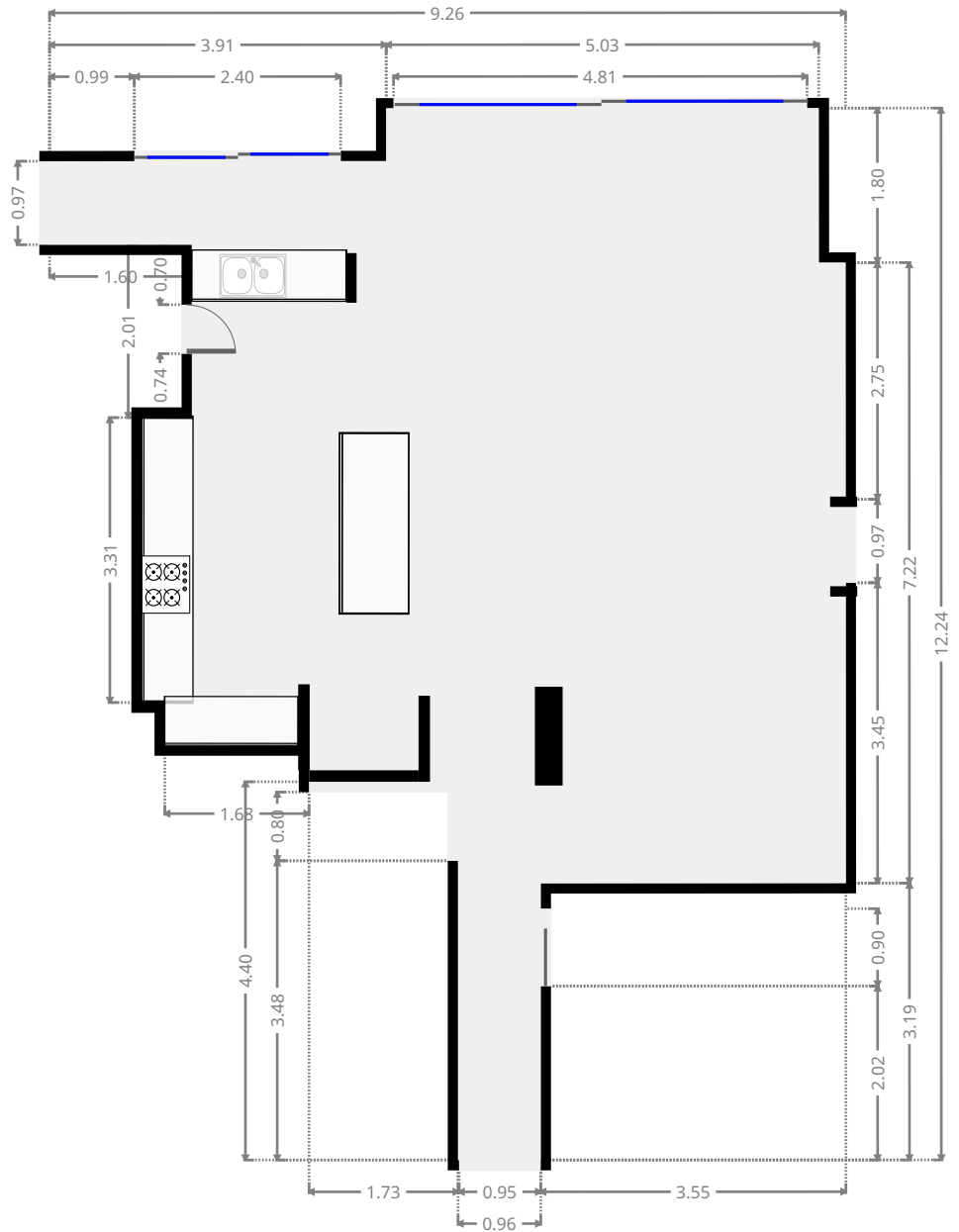
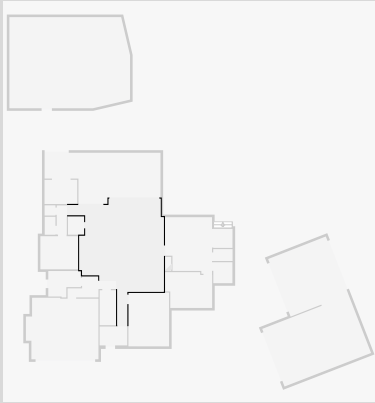

THIS FLOORPLAN IS PROVIDED WITHOUT WARRANTY OF ANY KIND. SENSOPIA DISCLAIMS ANY WARRANTY INCLUDING, WITHOUT LIMITATION, SATISFACTORY QUALITY OR ACCURACY OF DIMENSIONS.



# 10 Retreat Avenue

## 1st Floor

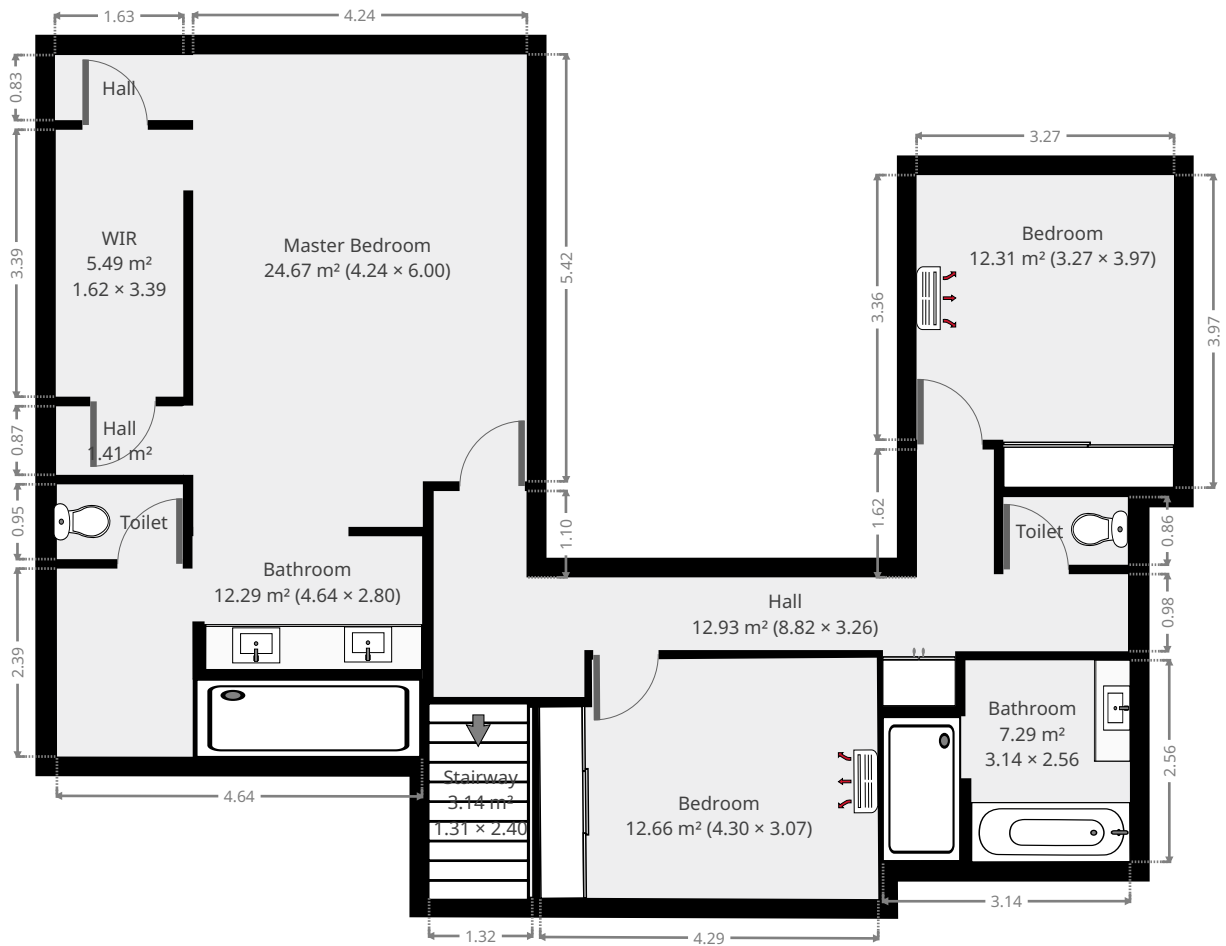

THIS FLOORPLAN IS PROVIDED WITHOUT WARRANTY OF ANY KIND. SENSOPIA DISCLAIMS ANY WARRANTY INCLUDING, WITHOUT LIMITATION, SATISFACTORY QUALITY OR ACCURACY OF DIMENSIONS.

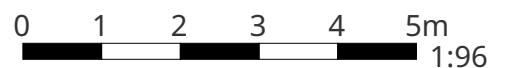

# 10 Retreat Avenue

## Hall

Width: 3.26 m  
 Length: 8.82 m  
 Area: 12.93 m<sup>2</sup>  
 Perimeter: 27.55 m

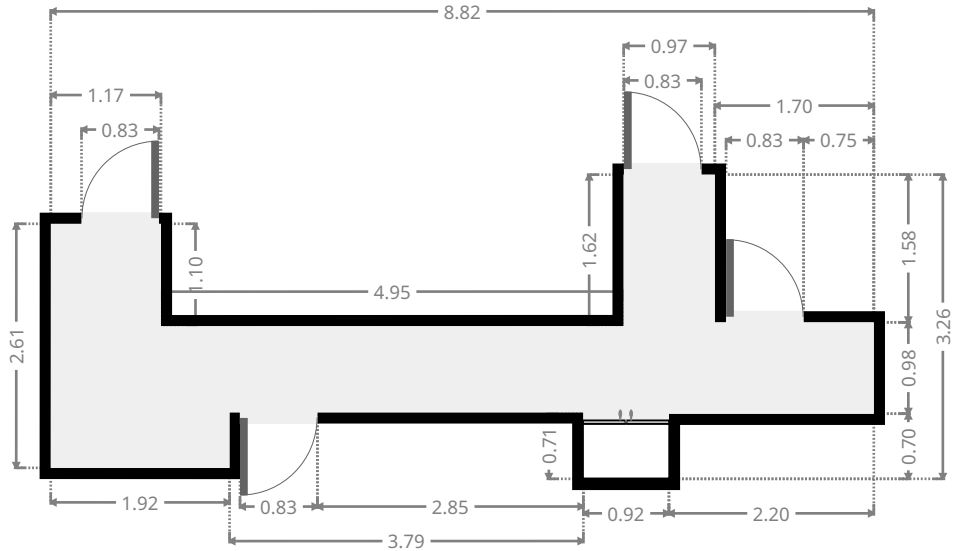
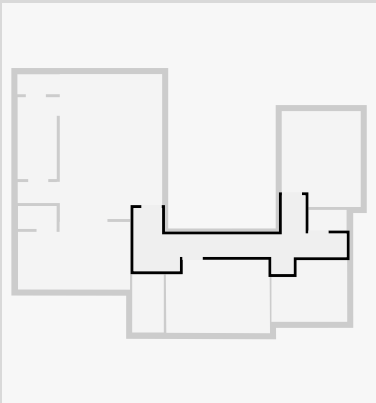

## Bedroom

Width: 3.27 m  
 Length: 3.97 m  
 Area: 12.31 m<sup>2</sup>  
 Perimeter: 14.48 m

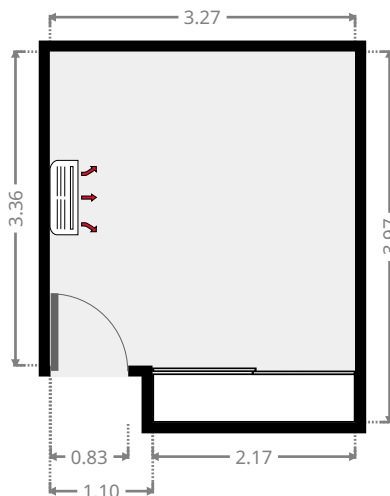
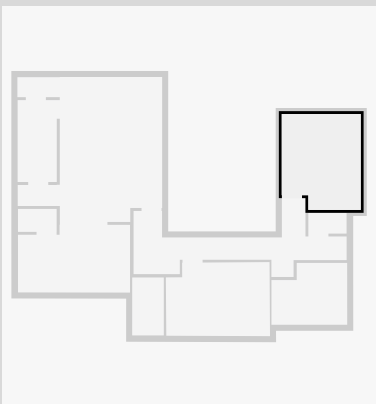

THIS FLOORPLAN IS PROVIDED WITHOUT WARRANTY OF ANY KIND. SENSOPIA DISCLAIMS ANY WARRANTY INCLUDING, WITHOUT LIMITATION, SATISFACTORY QUALITY OR ACCURACY OF DIMENSIONS.



# 10 Retreat Avenue

## Toilet / Half Bath

Width: 0.86 m  
 Length: 1.58 m  
 Area: 1.36 m<sup>2</sup>  
 Perimeter: 4.88 m

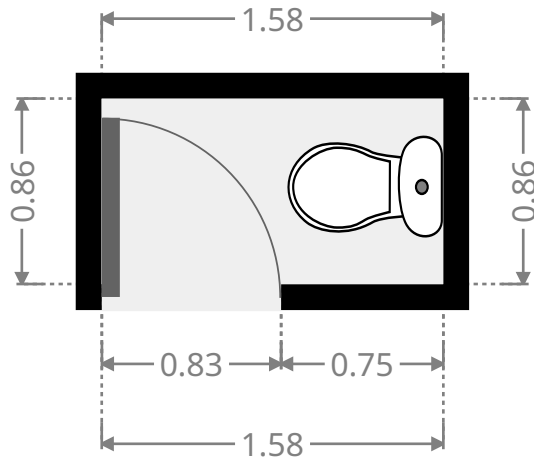
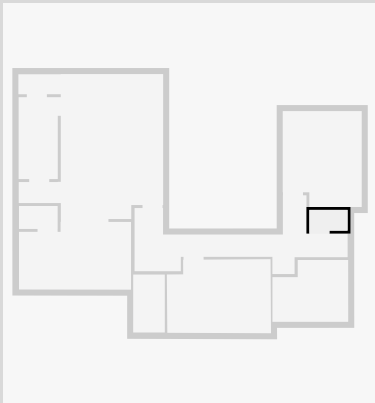

## Bathroom

Width: 2.56 m  
 Length: 3.14 m  
 Area: 7.29 m<sup>2</sup>  
 Perimeter: 11.39 m

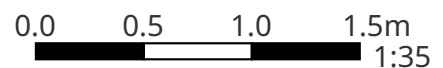
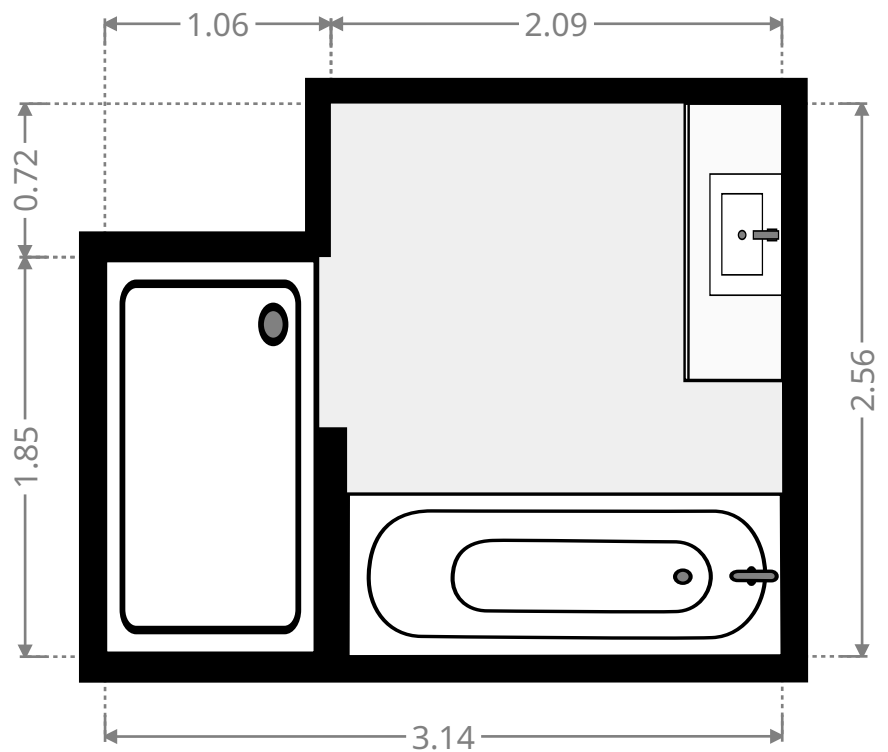
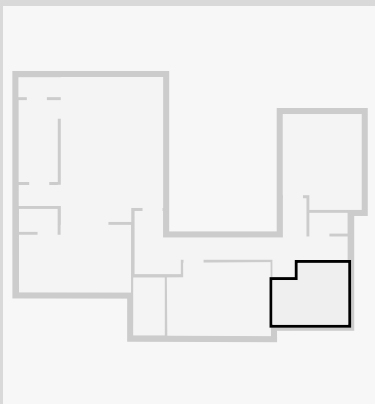

THIS FLOORPLAN IS PROVIDED WITHOUT WARRANTY OF ANY KIND. SENSOPIA DISCLAIMS ANY WARRANTY INCLUDING, WITHOUT LIMITATION, SATISFACTORY QUALITY OR ACCURACY OF DIMENSIONS.



# 10 Retreat Avenue

## Bedroom

Width: 3.07 m  
 Length: 4.30 m  
 Area: 12.66 m<sup>2</sup>  
 Perimeter: 14.68 m

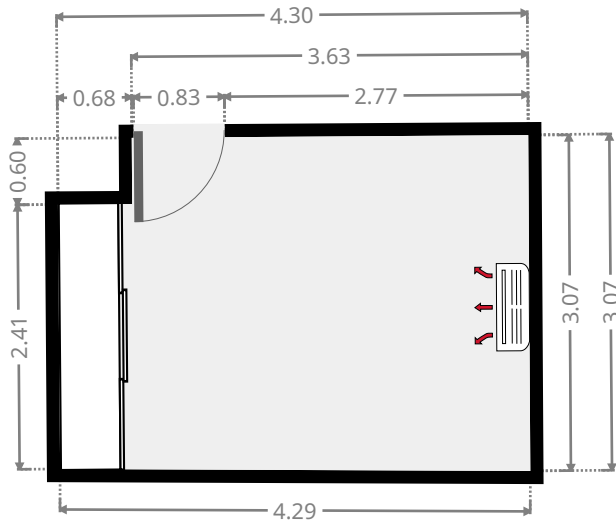
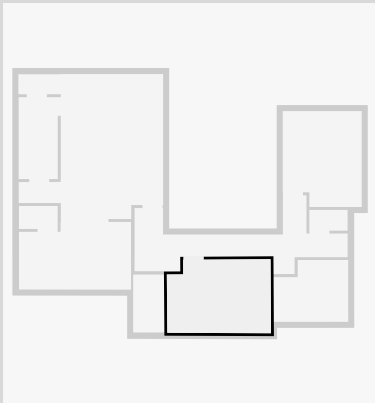

## Master Bedroom

Width: 4.24 m  
 Length: 6.00 m  
 Area: 24.67 m<sup>2</sup>  
 Perimeter: 20.48 m

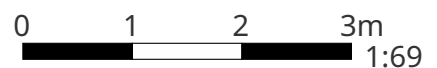
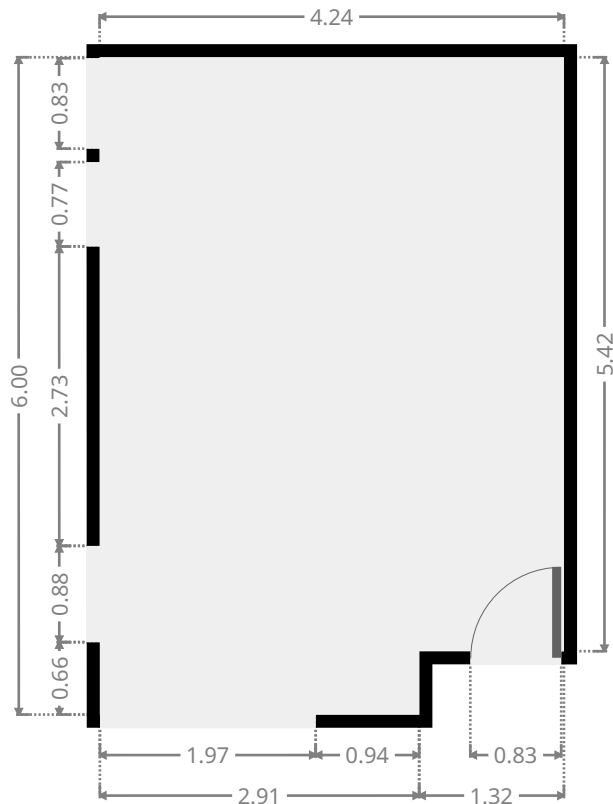
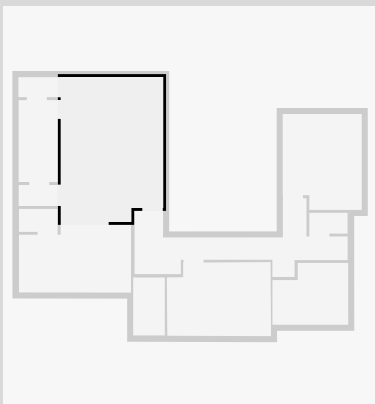

THIS FLOORPLAN IS PROVIDED WITHOUT WARRANTY OF ANY KIND. SENSOPIA DISCLAIMS ANY WARRANTY INCLUDING, WITHOUT LIMITATION, SATISFACTORY QUALITY OR ACCURACY OF DIMENSIONS.

# 10 Retreat Avenue

## Hall

Width: 0.87 m  
 Length: 1.62 m  
 Area: 1.41 m<sup>2</sup>  
 Perimeter: 4.98 m

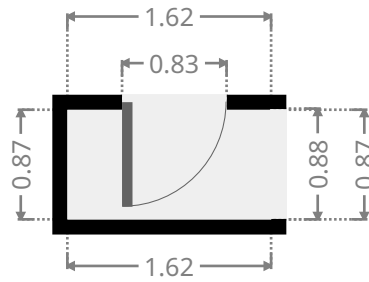
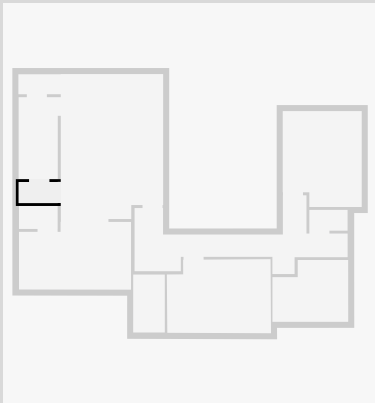

## WIR

Width: 1.62 m  
 Length: 3.39 m  
 Area: 5.49 m<sup>2</sup>  
 Perimeter: 10.02 m

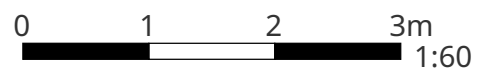
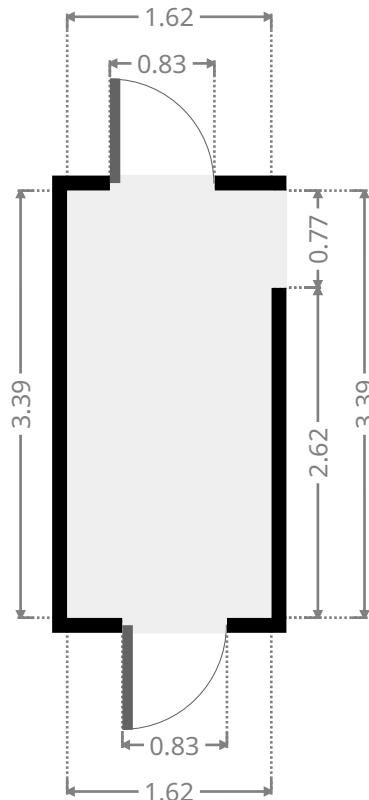
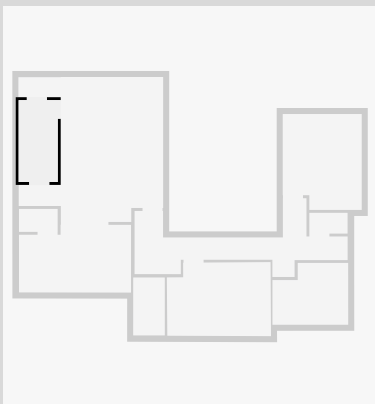

# 10 Retreat Avenue

## Hall

Width: 0.83 m  
 Length: 1.63 m  
 Area: 1.35 m<sup>2</sup>  
 Perimeter: 4.91 m

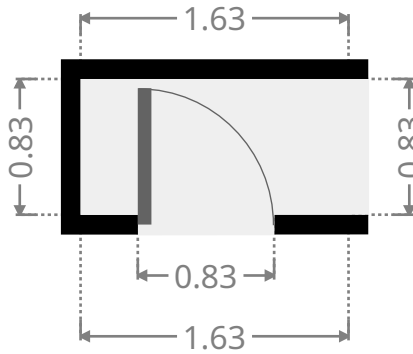
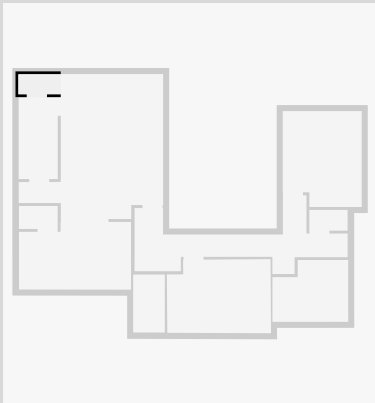

## Bathroom

Width: 2.80 m  
 Length: 4.64 m  
 Area: 12.29 m<sup>2</sup>  
 Perimeter: 14.88 m

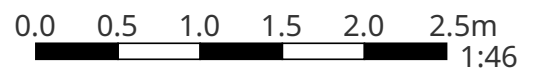
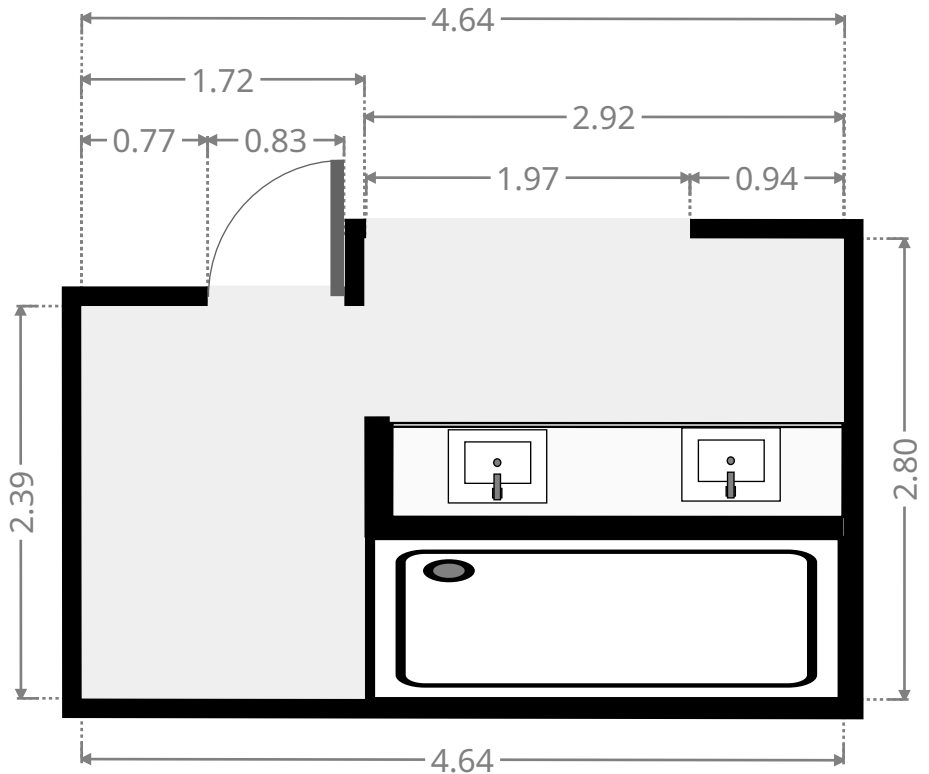
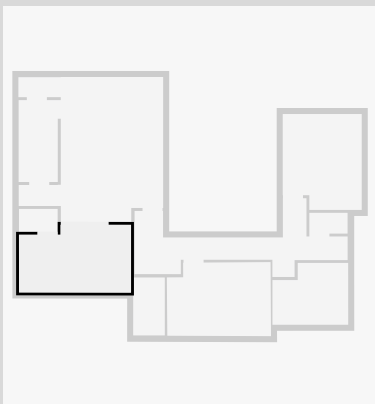

THIS FLOORPLAN IS PROVIDED WITHOUT WARRANTY OF ANY KIND. SENSOPIA DISCLAIMS ANY WARRANTY INCLUDING, WITHOUT LIMITATION, SATISFACTORY QUALITY OR ACCURACY OF DIMENSIONS.

# 10 Retreat Avenue

## Toilet / Half Bath

Width: 0.95 m  
Length: 1.60 m  
Area: 1.52 m<sup>2</sup>  
Perimeter: 5.10 m

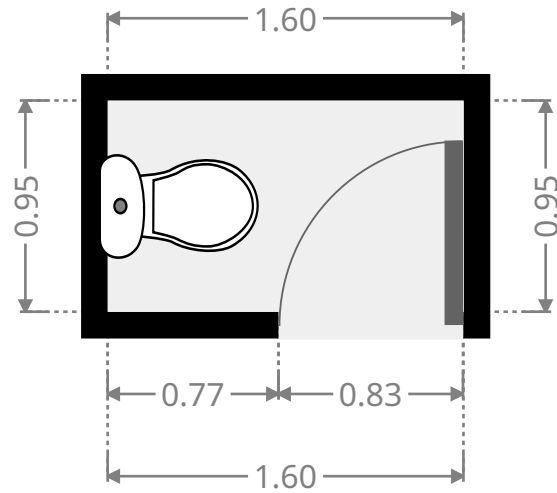
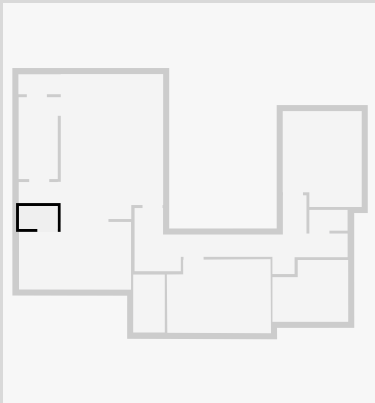

## Stairway

Width: 1.31 m  
Length: 2.40 m  
Area: 3.14 m<sup>2</sup>  
Perimeter: 7.41 m

