

# 10 Ottaway Street

**SUBMITTED BY**

Ray White Rockhampton Casey  
stockers@cqoz.com

---

**CREATED ON**

2021-11-25

---

**Floors**

2

---

▼ Ground Floor

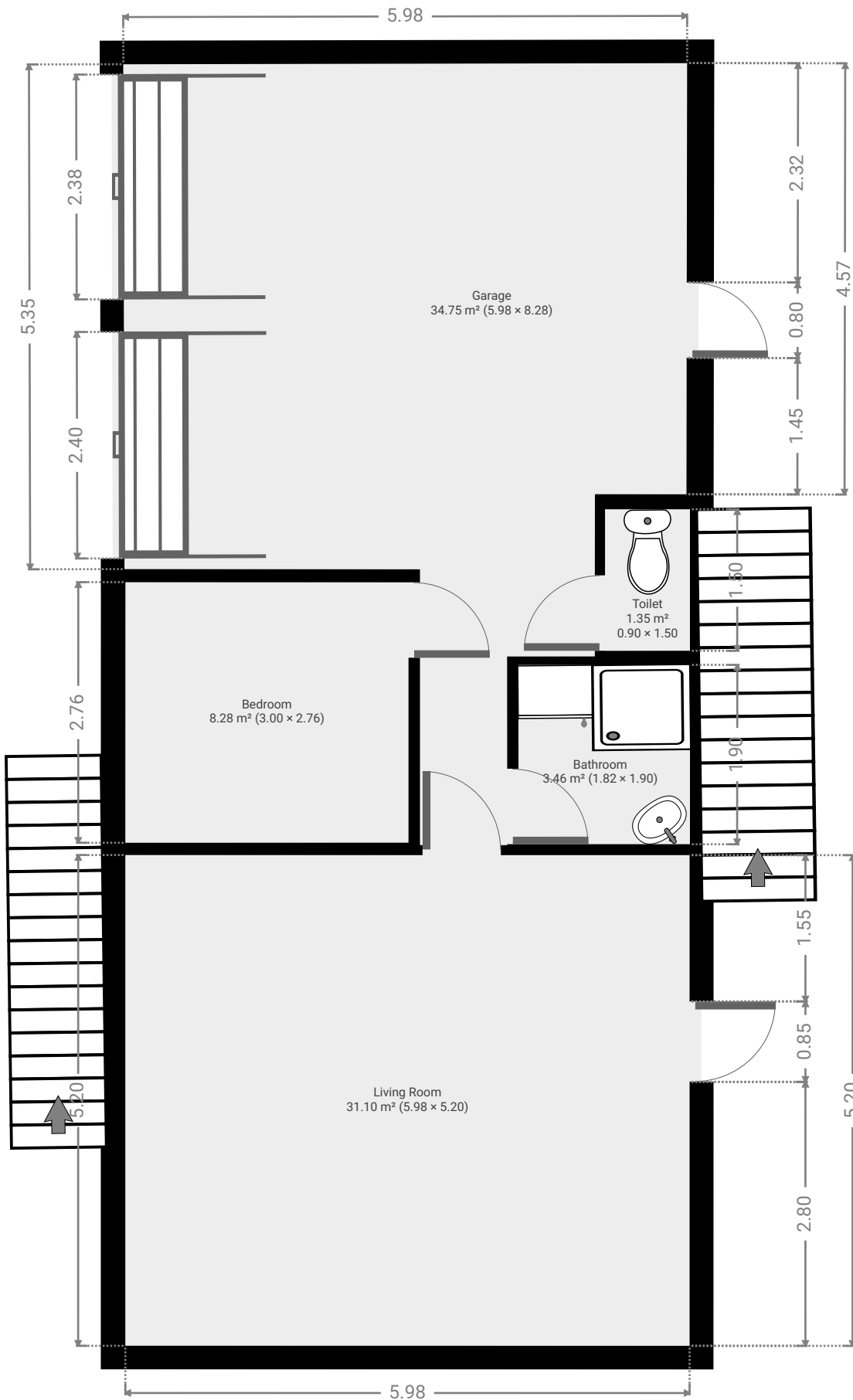

▼ **Living Room**  
Ground Floor

WIDTH: 5.20 m • LENGTH: 5.98 m  
AREA: 31.10 m<sup>2</sup> • PERIMETER: 22.36 m

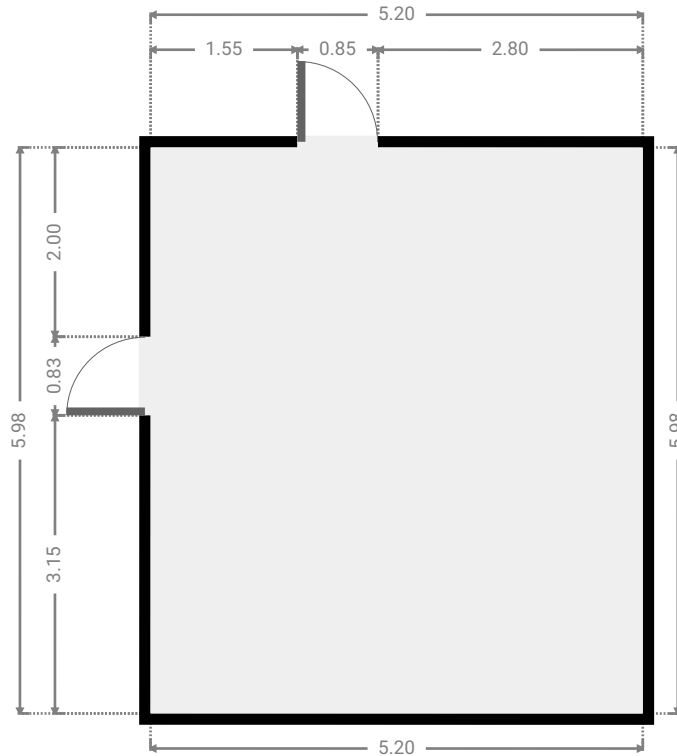
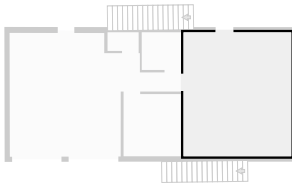

▼ **Bedroom**  
Ground Floor

WIDTH: 2.76 m • LENGTH: 3.00 m  
AREA: 8.28 m<sup>2</sup> • PERIMETER: 11.52 m

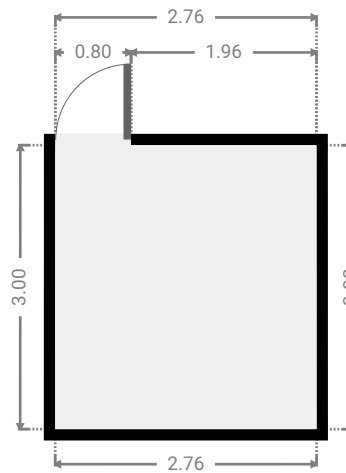
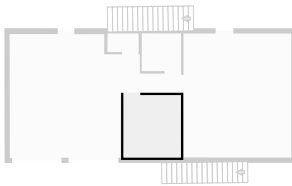

▼ **Garage**  
Ground Floor

WIDTH: 8.28 m • LENGTH: 5.98 m  
AREA: 34.75 m<sup>2</sup> • PERIMETER: 28.50 m

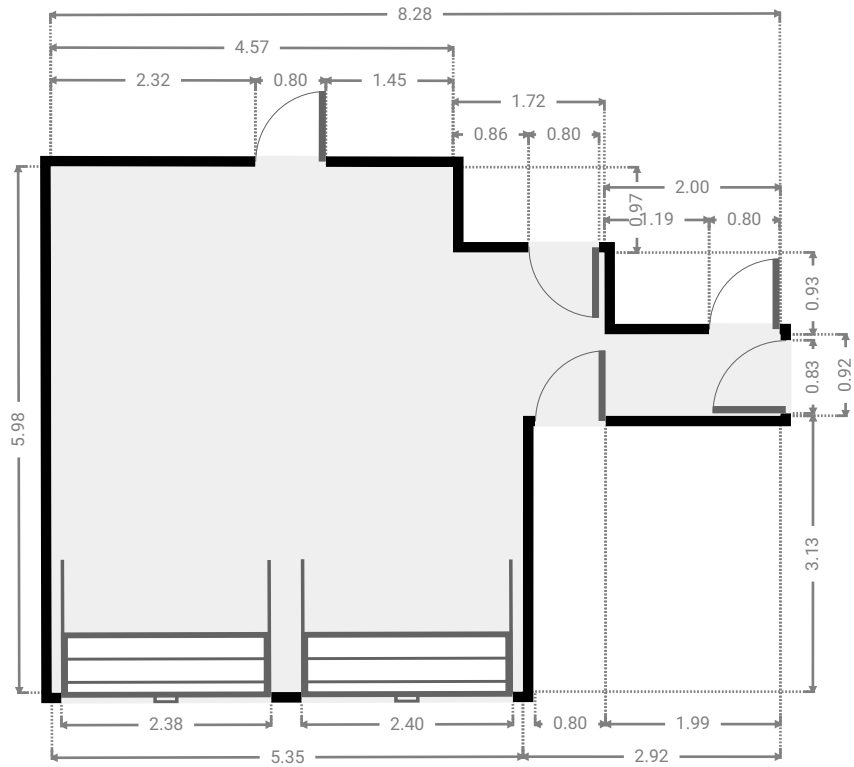
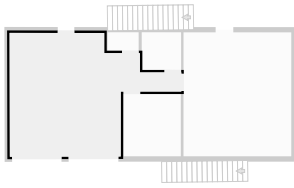

▼ **Toilet**  
Ground Floor

WIDTH: 1.50 m • LENGTH: 0.90 m  
AREA: 1.35 m<sup>2</sup> • PERIMETER: 4.80 m

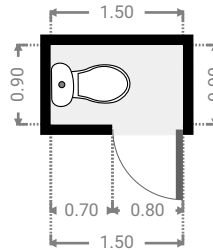
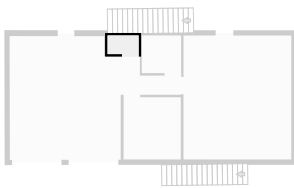

▼ **Bathroom**  
Ground Floor

WIDTH: 1.90 m • LENGTH: 1.82 m  
AREA: 3.46 m<sup>2</sup> • PERIMETER: 7.44 m

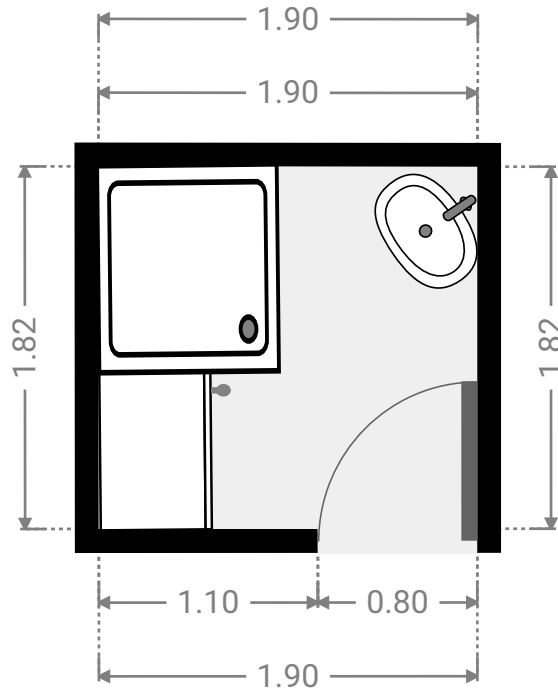
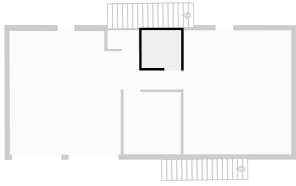

▼ 1st Floor

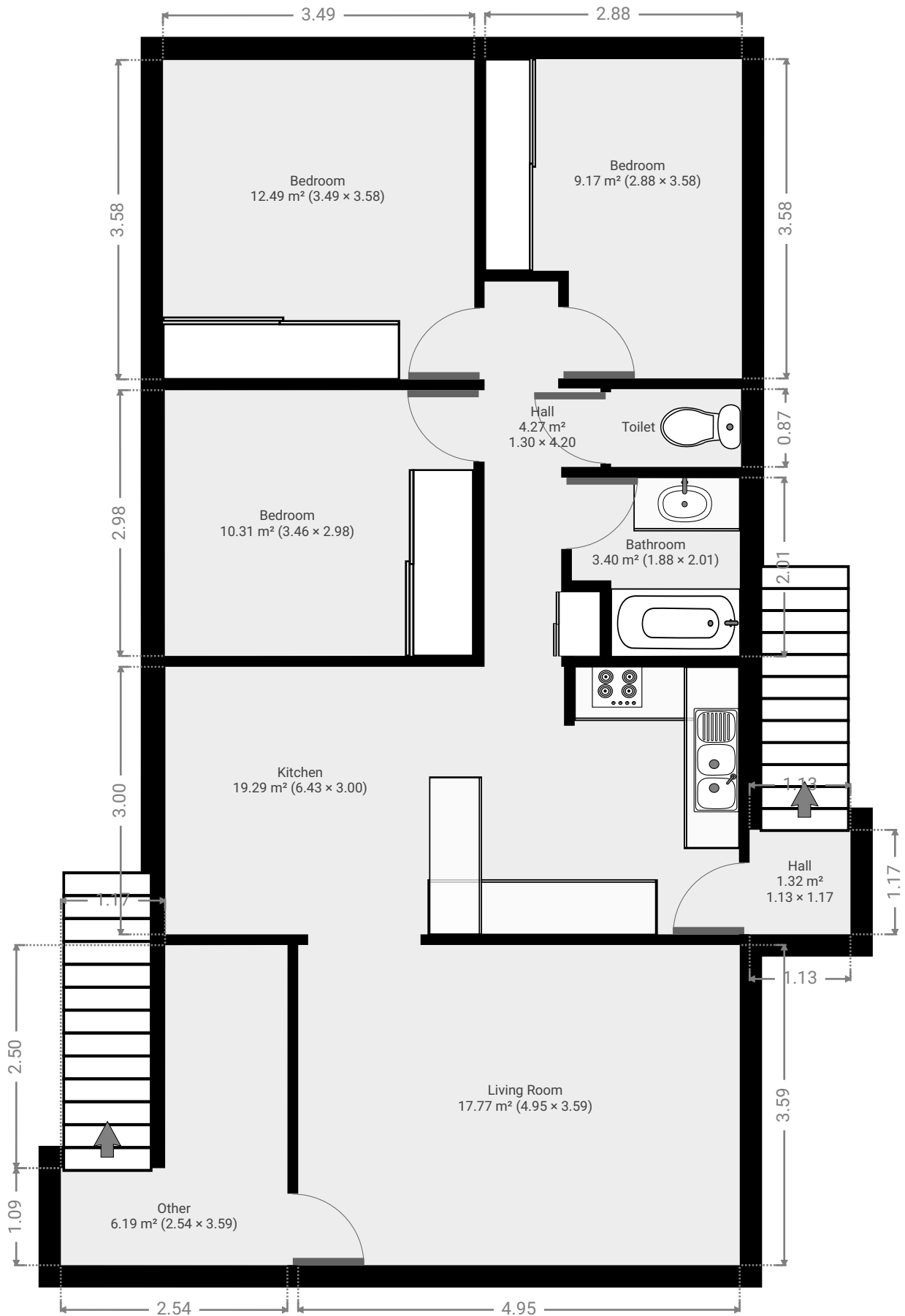

▼ Living Room  
1st Floor

WIDTH: 3.59 m • LENGTH: 4.95 m  
AREA: 17.77 m<sup>2</sup> • PERIMETER: 17.08 m

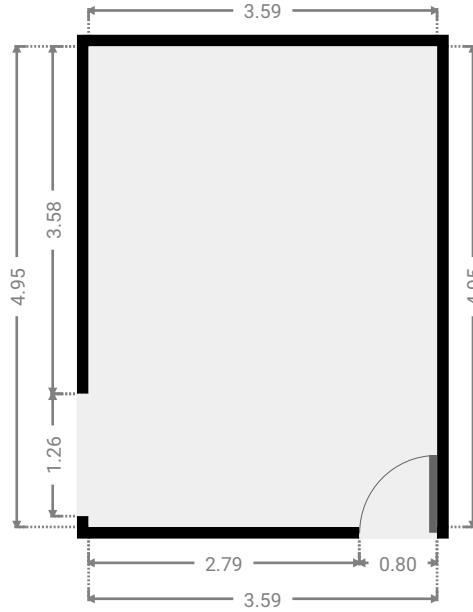
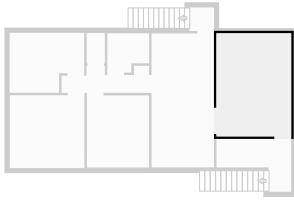

▼ Kitchen  
1st Floor

WIDTH: 3.00 m • LENGTH: 6.43 m  
AREA: 19.29 m<sup>2</sup> • PERIMETER: 18.86 m

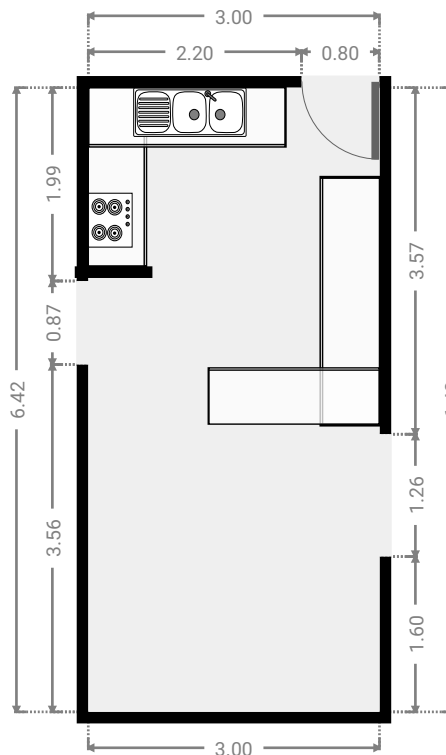
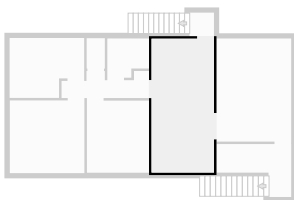

▼ **Hall**  
1st Floor

WIDTH: 4.20 m • LENGTH: 1.30 m  
AREA: 4.27 m<sup>2</sup> • PERIMETER: 11.88 m

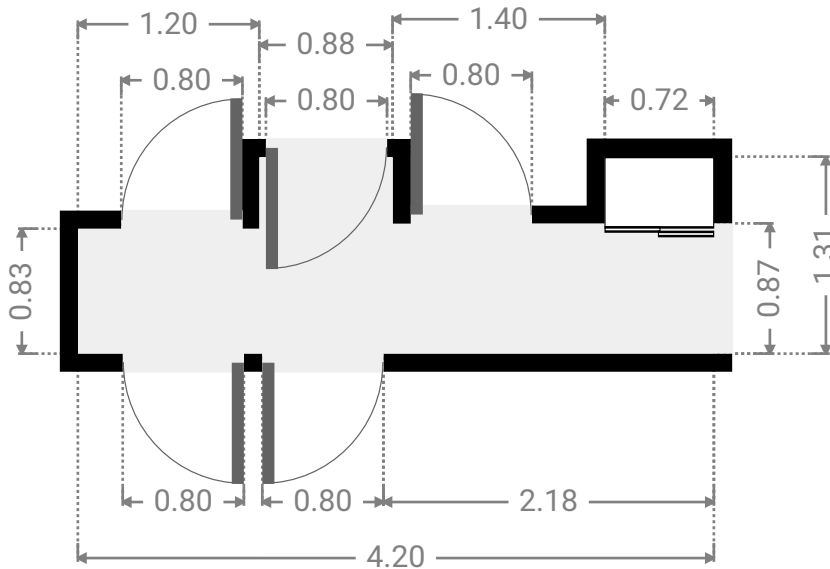
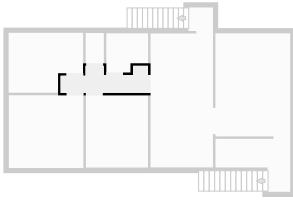

▼ **Bedroom**  
1st Floor

WIDTH: 2.98 m • LENGTH: 3.46 m  
AREA: 10.31 m<sup>2</sup> • PERIMETER: 12.88 m

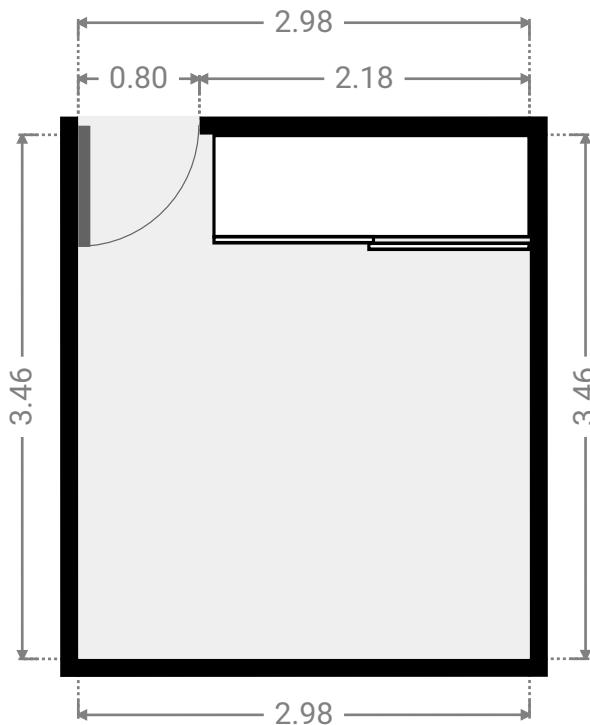
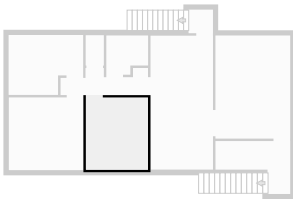



▼ **Bedroom**  
1st Floor

WIDTH: 3.58 m • LENGTH: 3.49 m  
AREA: 12.49 m<sup>2</sup> • PERIMETER: 14.14 m

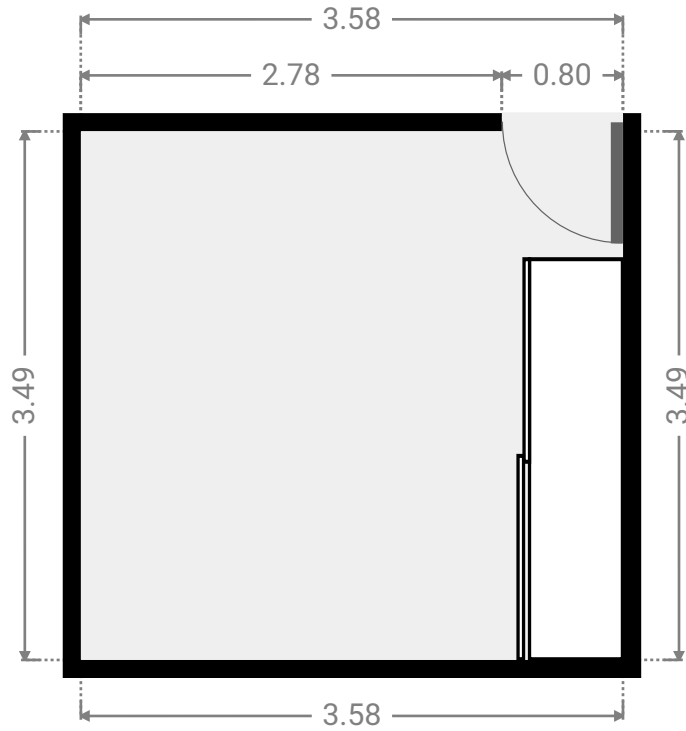
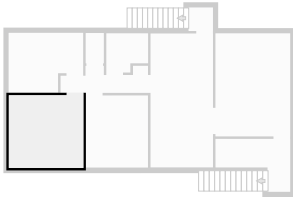

▼ **Bedroom**  
1st Floor

WIDTH: 3.58 m • LENGTH: 2.88 m  
AREA: 9.17 m<sup>2</sup> • PERIMETER: 12.92 m

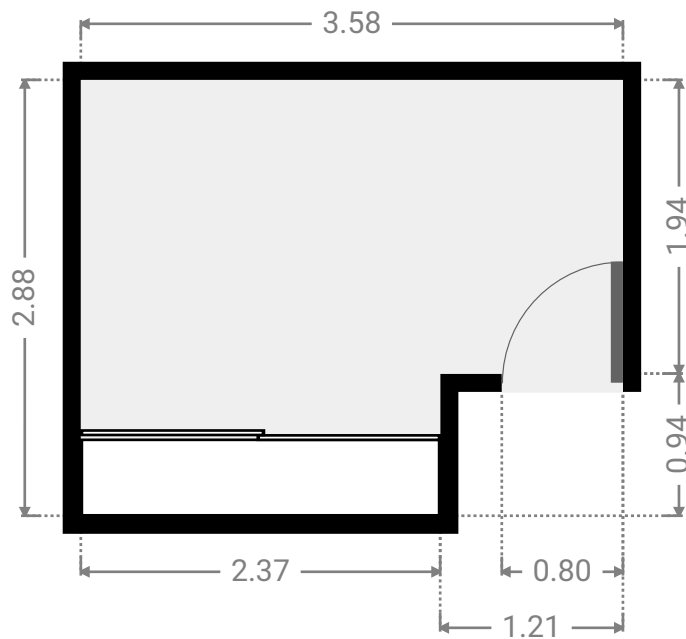
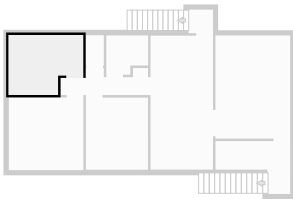

▼ **Toilet**  
1st Floor

WIDTH: 0.87 m • LENGTH: 1.46 m  
AREA: 1.27 m<sup>2</sup> • PERIMETER: 4.66 m

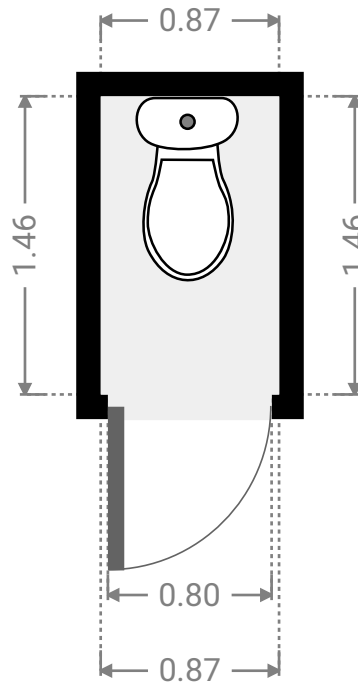
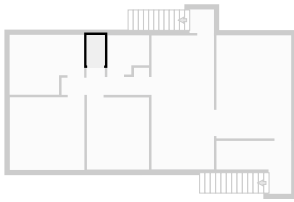

▼ **Bathroom**  
1st Floor

WIDTH: 2.01 m • LENGTH: 1.88 m  
AREA: 3.40 m<sup>2</sup> • PERIMETER: 7.78 m

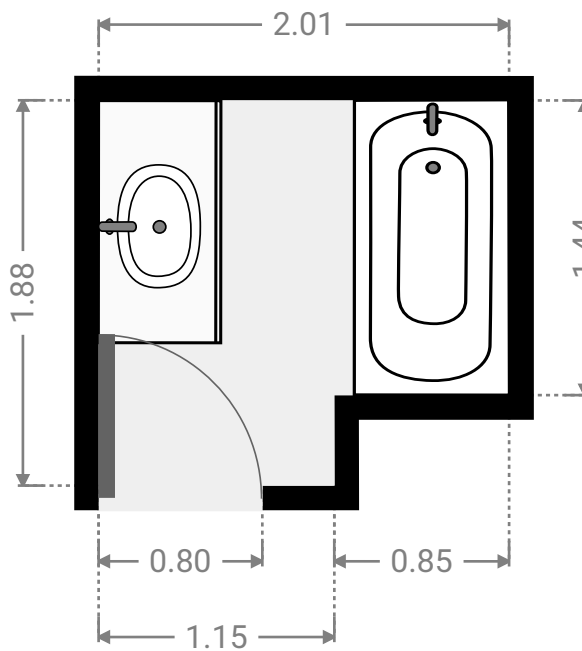
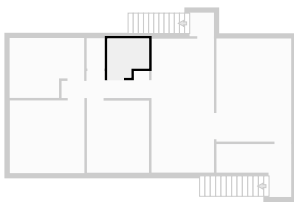

▼ **Hall**  
1st Floor

WIDTH: 1.17 m • LENGTH: 1.13 m  
AREA: 1.32 m<sup>2</sup> • PERIMETER: 4.60 m

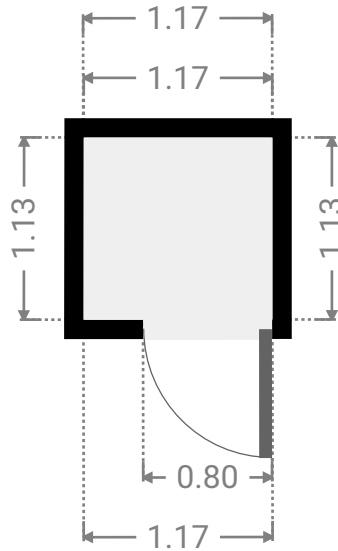
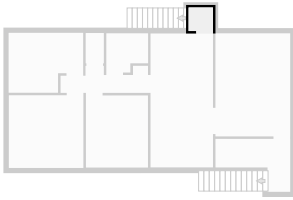

▼ **Other**  
1st Floor

WIDTH: 3.59 m • LENGTH: 2.54 m  
AREA: 6.19 m<sup>2</sup> • PERIMETER: 12.26 m

