

Ground Floor



10 Messmade Court

THIS FLOORPLAN IS PROVIDED WITHOUT WARRANTY OF ANY KIND. SENSOPIA DISCLAIMS ANY WARRANTY INCLUDING, WITHOUT LIMITATION, SATISFACTORY QUALITY OR ACCURACY OF DIMENSIONS.

Bedroom

Width: 3.08 m
 Length: 3.99 m
 Area: 10.94 m²
 Perimeter: 14.14 m
 Ceiling Height: 2.17 m

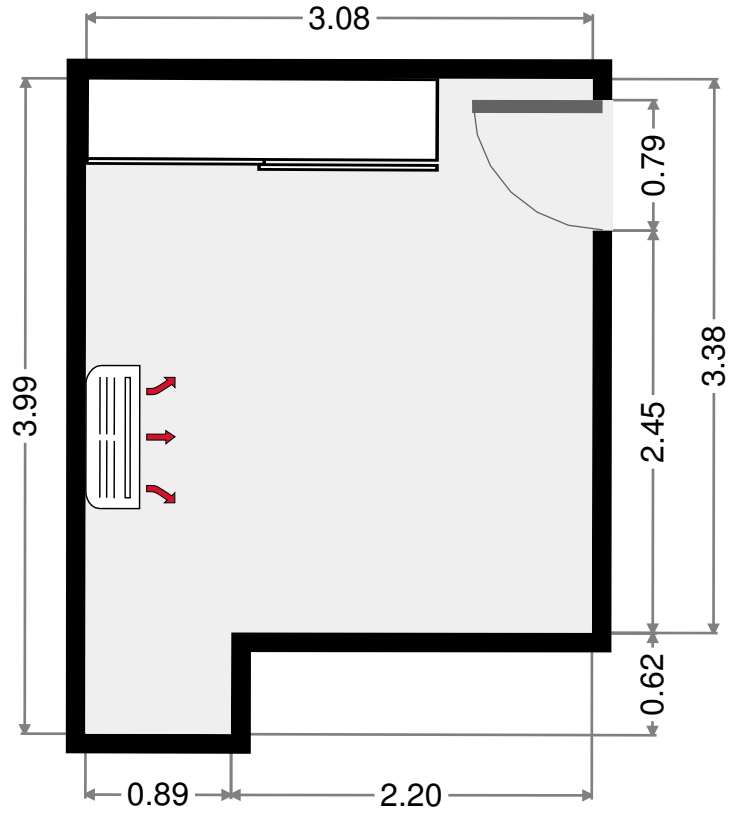
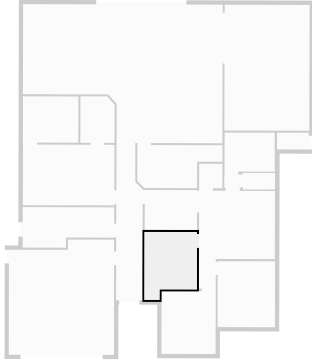

Toilet

Width: 0.98 m
 Length: 1.87 m
 Area: 1.84 m²
 Perimeter: 5.71 m

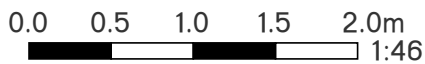
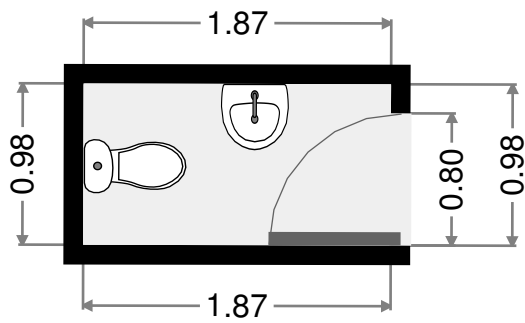
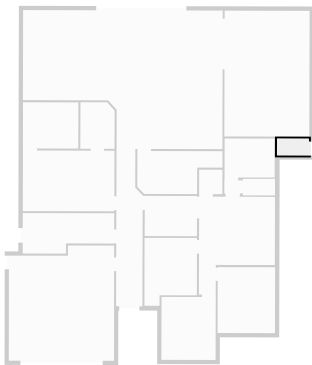

THIS FLOORPLAN IS PROVIDED WITHOUT WARRANTY OF ANY KIND. SENSOPIA DISCLAIMS ANY WARRANTY INCLUDING, WITHOUT LIMITATION, SATISFACTORY QUALITY OR ACCURACY OF DIMENSIONS.

Outdoor Area

Width: 4.99 m
 Length: 7.39 m
 Area: 36.91 m²
 Perimeter: 24.77 m

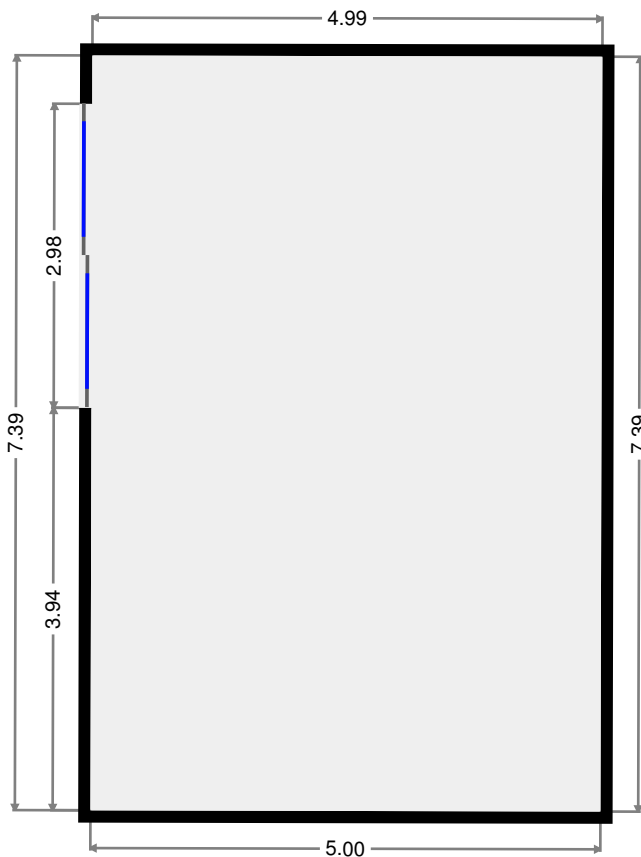
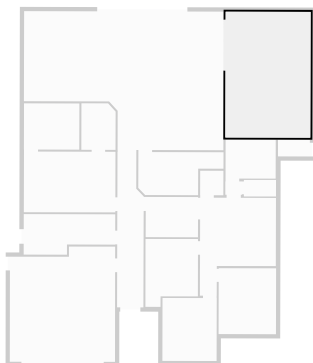

Pantry

Width: 2.53 m
 Length: 5.00 m
 Area: 10.23 m²
 Perimeter: 14.81 m

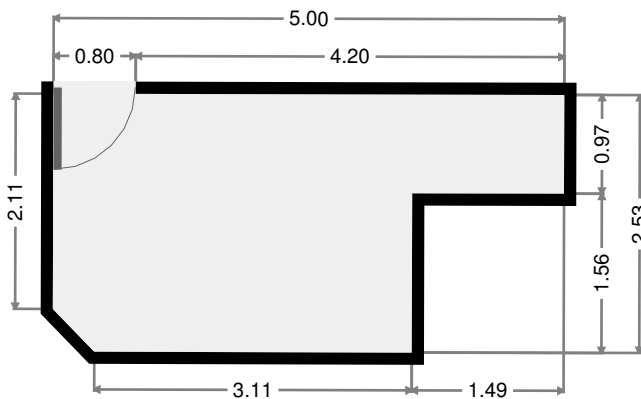
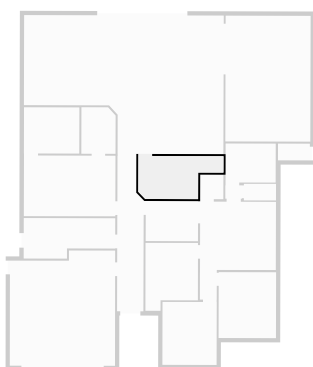

THIS FLOORPLAN IS PROVIDED WITHOUT WARRANTY OF ANY KIND. SENSOPIA DISCLAIMS ANY WARRANTY INCLUDING, WITHOUT LIMITATION, SATISFACTORY QUALITY OR ACCURACY OF DIMENSIONS.

Dining Room

Width: 8.14 m
Length: 11.73 m
Area: 79.95 m²
Perimeter: 39.44 m
Ceiling Height: 2.17 m

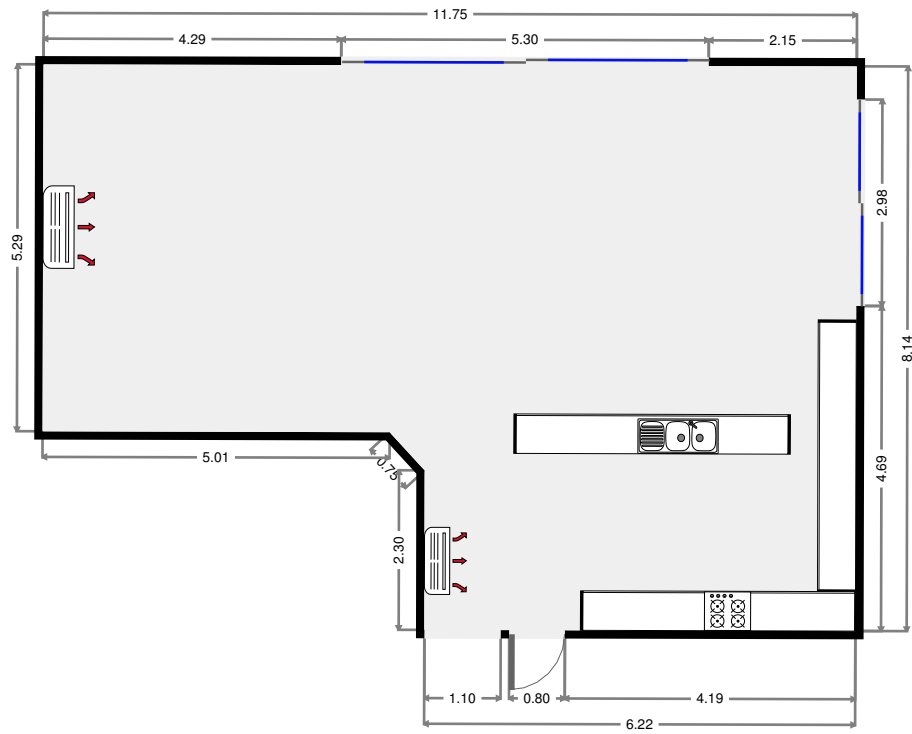
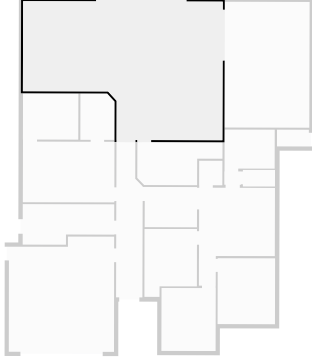

THIS FLOORPLAN IS PROVIDED WITHOUT WARRANTY OF ANY KIND. SENSOPIA DISCLAIMS ANY WARRANTY INCLUDING, WITHOUT LIMITATION, SATISFACTORY QUALITY OR ACCURACY OF DIMENSIONS.

Bathroom

Width: 2.29 m
 Length: 2.94 m
 Area: 6.74 m²
 Perimeter: 10.47 m

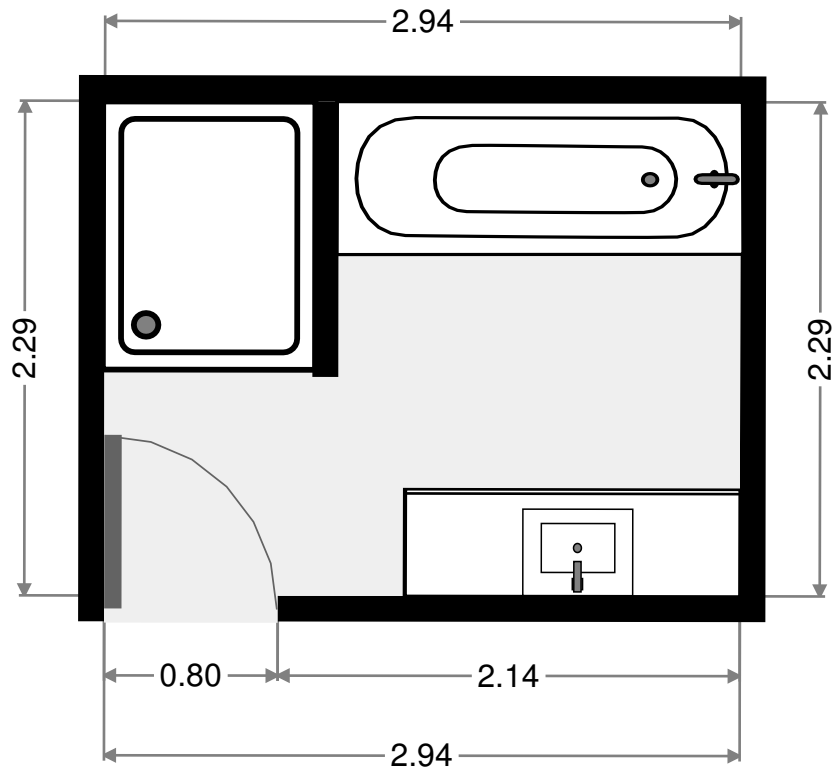
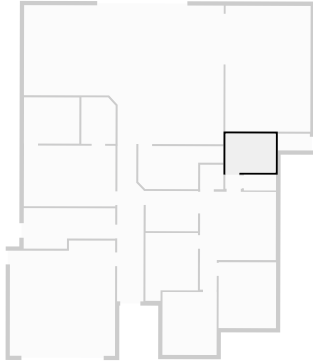

Toilet

Width: 0.99 m
 Length: 1.89 m
 Area: 1.84 m²
 Perimeter: 5.72 m

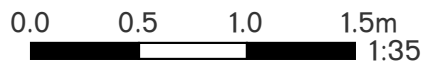
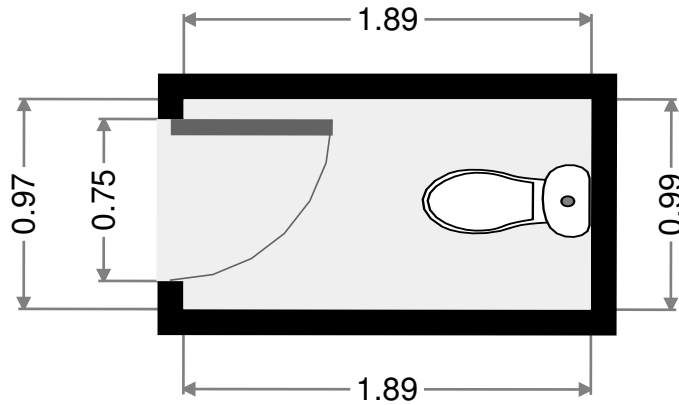
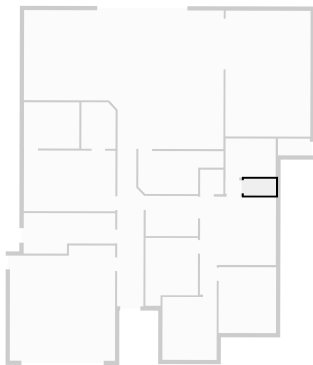

THIS FLOORPLAN IS PROVIDED WITHOUT WARRANTY OF ANY KIND. SENSOPIA DISCLAIMS ANY WARRANTY INCLUDING, WITHOUT LIMITATION, SATISFACTORY QUALITY OR ACCURACY OF DIMENSIONS.

Hall

Width: 0.78 m
 Length: 0.98 m
 Area: 0.76 m²
 Perimeter: 3.52 m

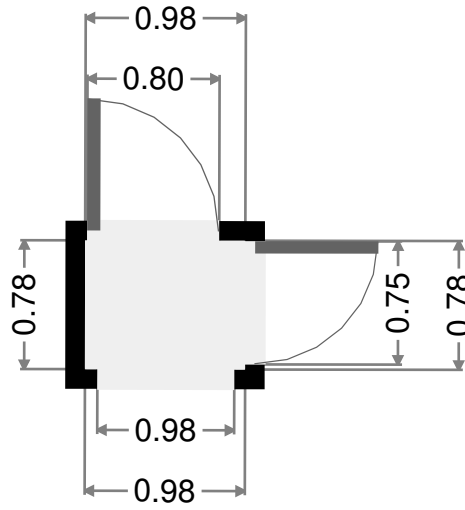
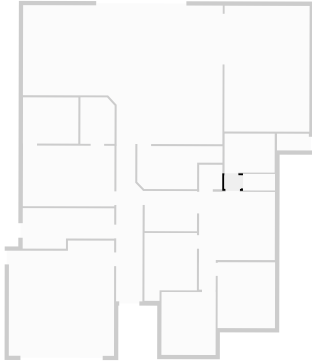

Bedroom

Width: 3.18 m
 Length: 3.70 m
 Area: 11.77 m²
 Perimeter: 13.76 m

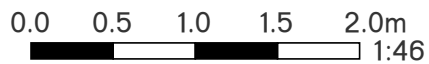
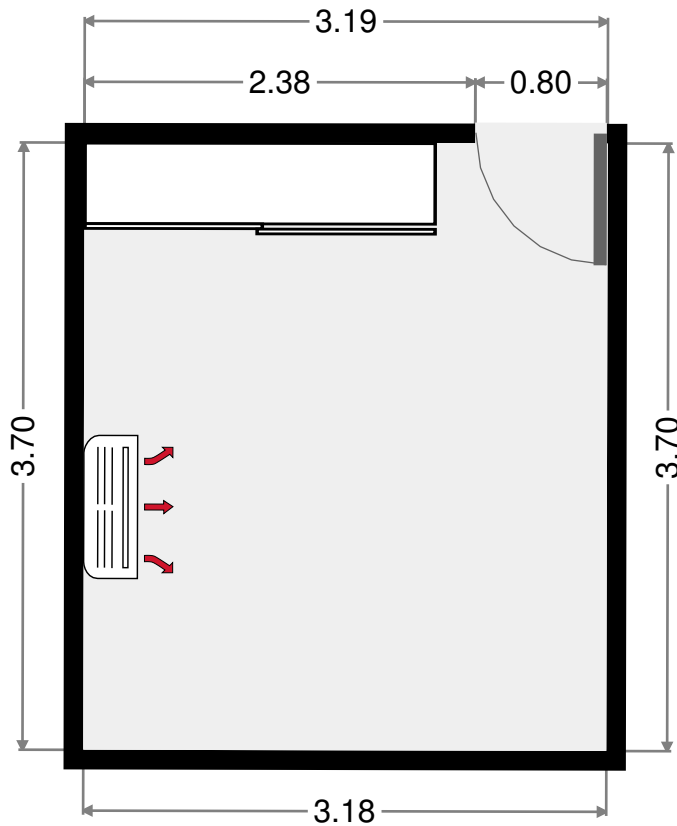
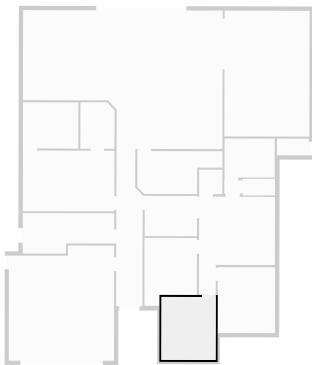

THIS FLOORPLAN IS PROVIDED WITHOUT WARRANTY OF ANY KIND. SENSOPIA DISCLAIMS ANY WARRANTY INCLUDING, WITHOUT LIMITATION, SATISFACTORY QUALITY OR ACCURACY OF DIMENSIONS.

Bedroom

Width: 3.37 m
 Length: 3.87 m
 Area: 13.05 m²
 Perimeter: 14.48 m

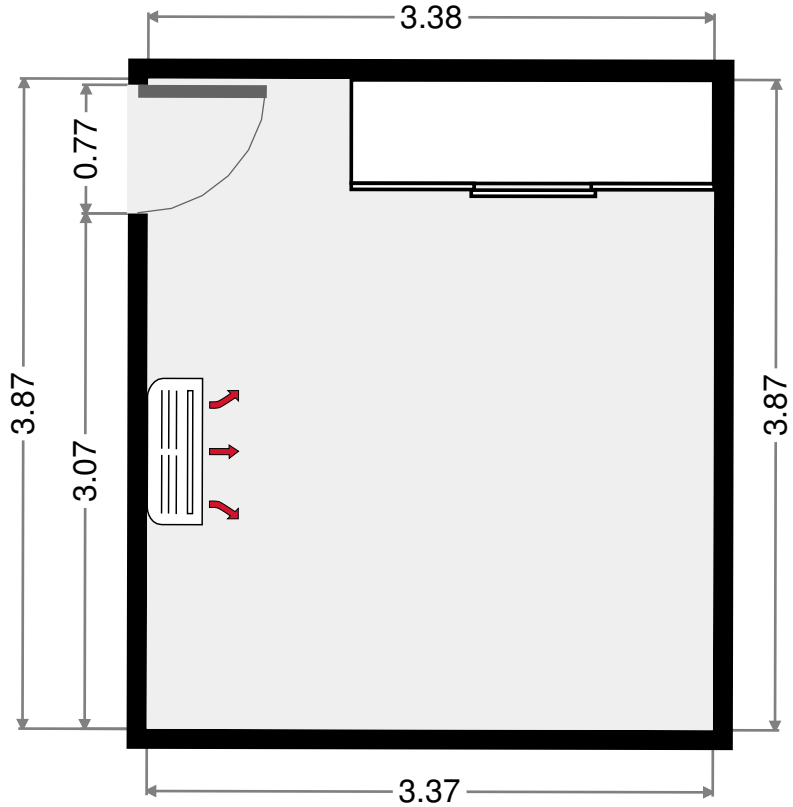
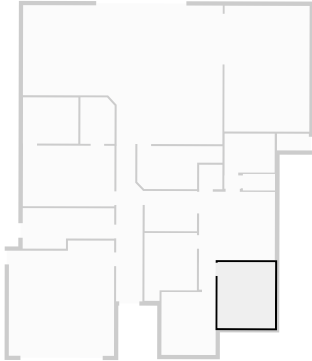

Hall

Width: 0.99 m
 Length: 1.58 m
 Area: 1.57 m²
 Perimeter: 5.16 m

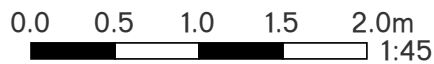
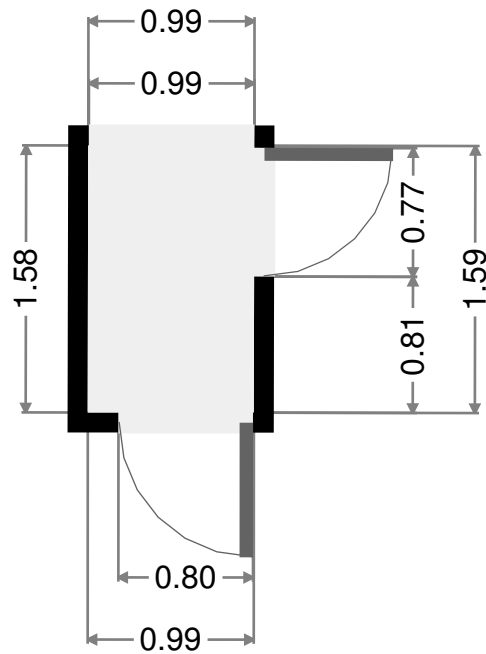
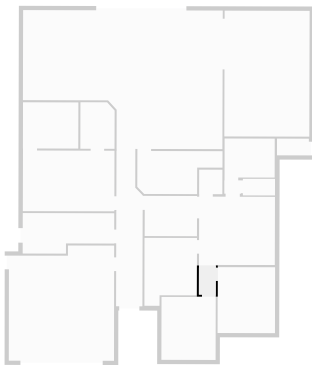

THIS FLOORPLAN IS PROVIDED WITHOUT WARRANTY OF ANY KIND. SENSOPIA DISCLAIMS ANY WARRANTY INCLUDING, WITHOUT LIMITATION, SATISFACTORY QUALITY OR ACCURACY OF DIMENSIONS.

Hall

Width: 1.55 m
 Length: 5.48 m
 Area: 8.47 m²
 Perimeter: 14.04 m

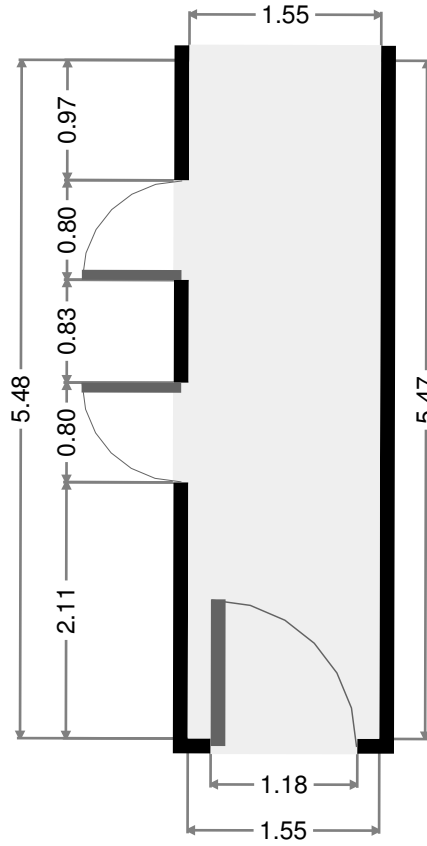
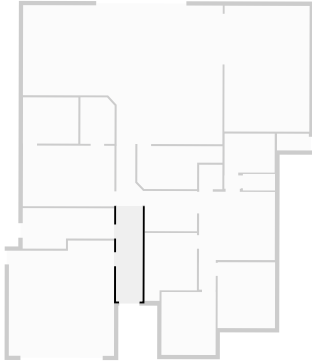

Closet

Width: 1.36 m
 Length: 1.44 m
 Area: 1.96 m²
 Perimeter: 5.60 m

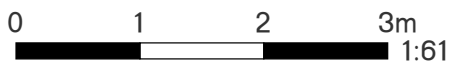
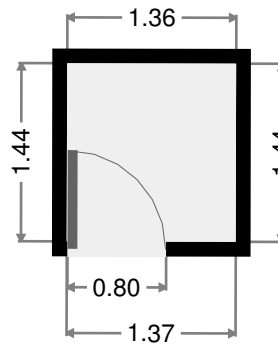
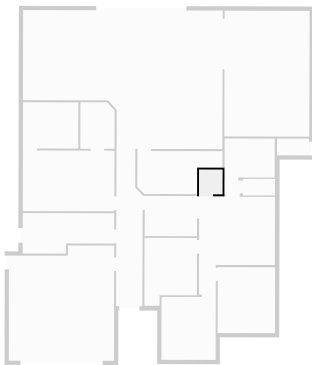

THIS FLOORPLAN IS PROVIDED WITHOUT WARRANTY OF ANY KIND. SENSOPIA DISCLAIMS ANY WARRANTY INCLUDING, WITHOUT LIMITATION, SATISFACTORY QUALITY OR ACCURACY OF DIMENSIONS.

Living Room

Width: 4.02 m
 Length: 4.45 m
 Area: 17.87 m²
 Perimeter: 16.93 m

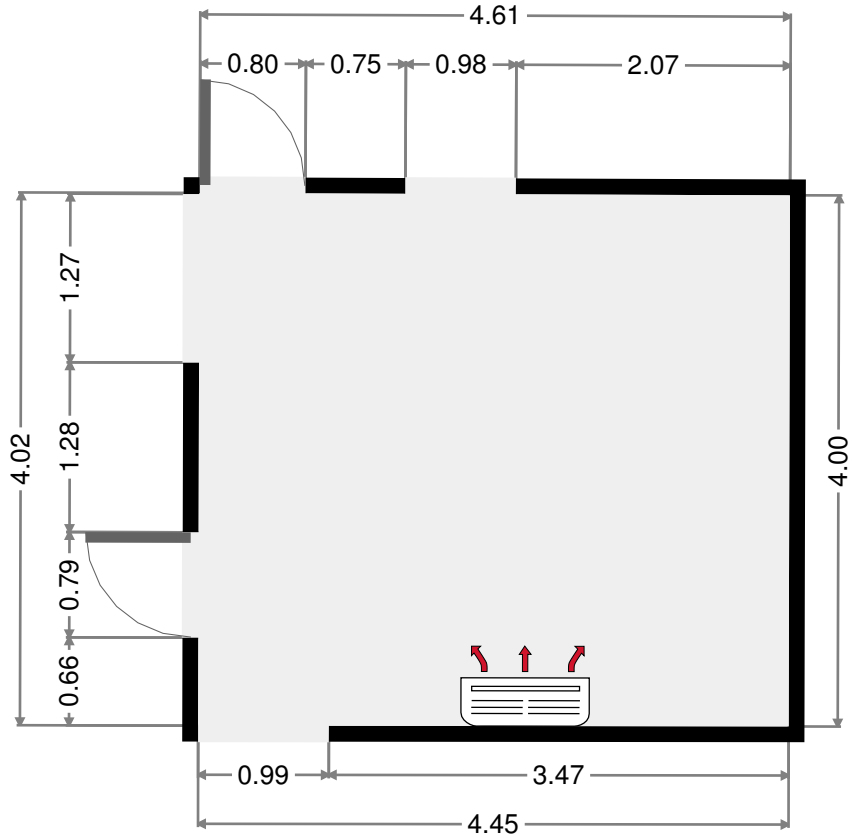
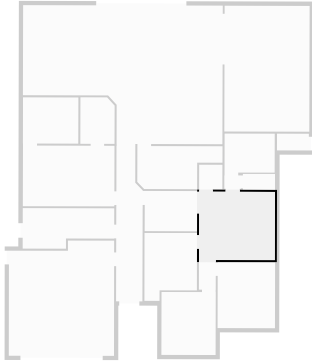

Hall

Width: 2.37 m
 Length: 3.07 m
 Area: 7.26 m²
 Perimeter: 10.87 m

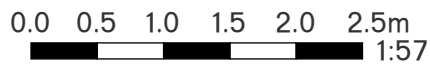
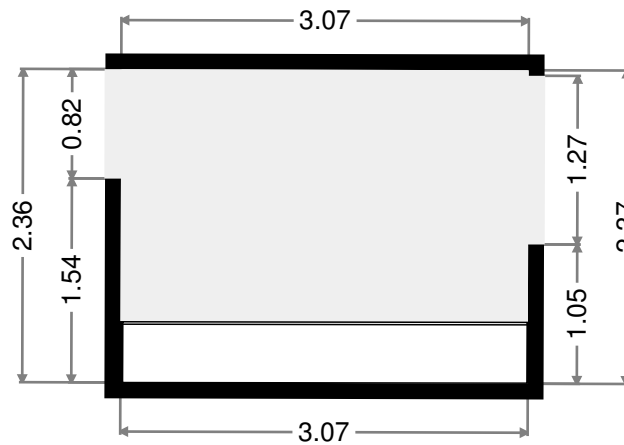
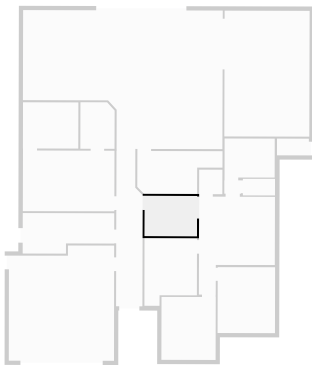

THIS FLOORPLAN IS PROVIDED WITHOUT WARRANTY OF ANY KIND. SENSOPIA DISCLAIMS ANY WARRANTY INCLUDING, WITHOUT LIMITATION, SATISFACTORY QUALITY OR ACCURACY OF DIMENSIONS.

WIR

Width: 2.01 m
 Length: 2.74 m
 Area: 5.38 m²
 Perimeter: 9.21 m
 Ceiling Height: 2.17 m

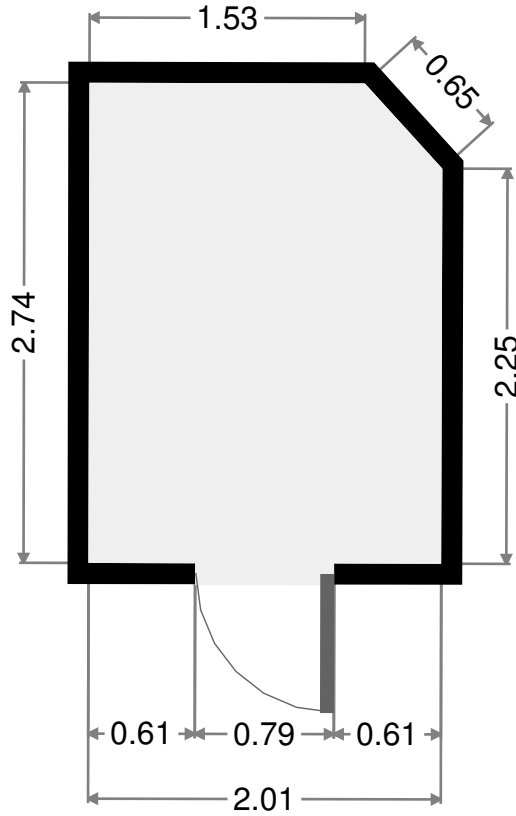
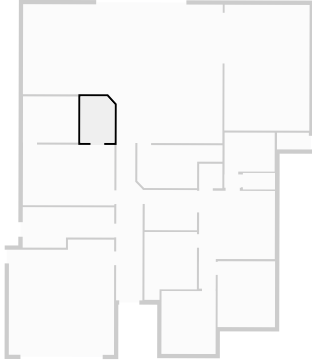

Bathroom

Width: 2.71 m
 Length: 3.25 m
 Area: 8.82 m²
 Perimeter: 11.93 m

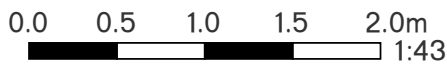
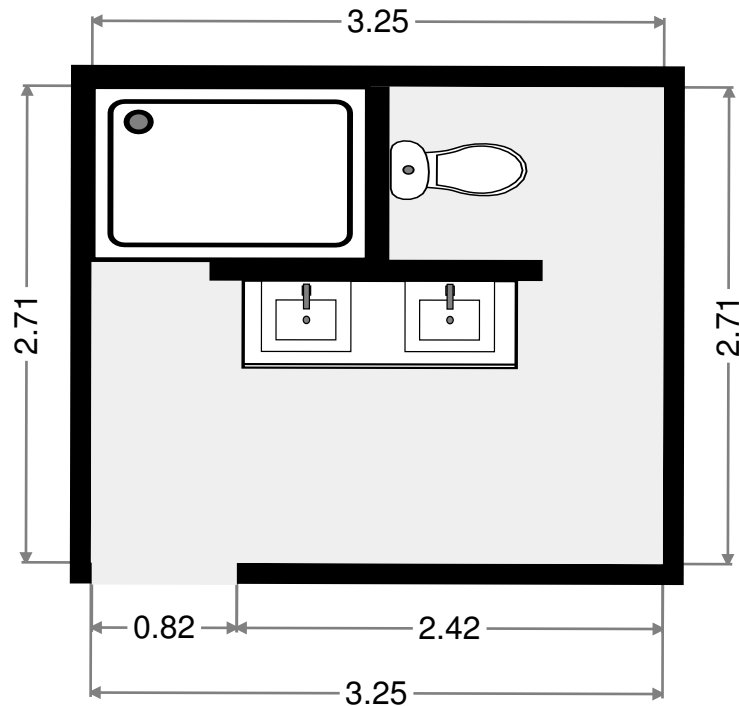
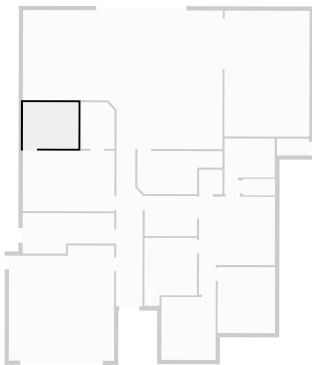

THIS FLOORPLAN IS PROVIDED WITHOUT WARRANTY OF ANY KIND. SENSOPIA DISCLAIMS ANY WARRANTY INCLUDING, WITHOUT LIMITATION, SATISFACTORY QUALITY OR ACCURACY OF DIMENSIONS.

Master Bedroom

Width: 3.57 m
 Length: 5.38 m
 Area: 19.16 m²
 Perimeter: 17.88 m

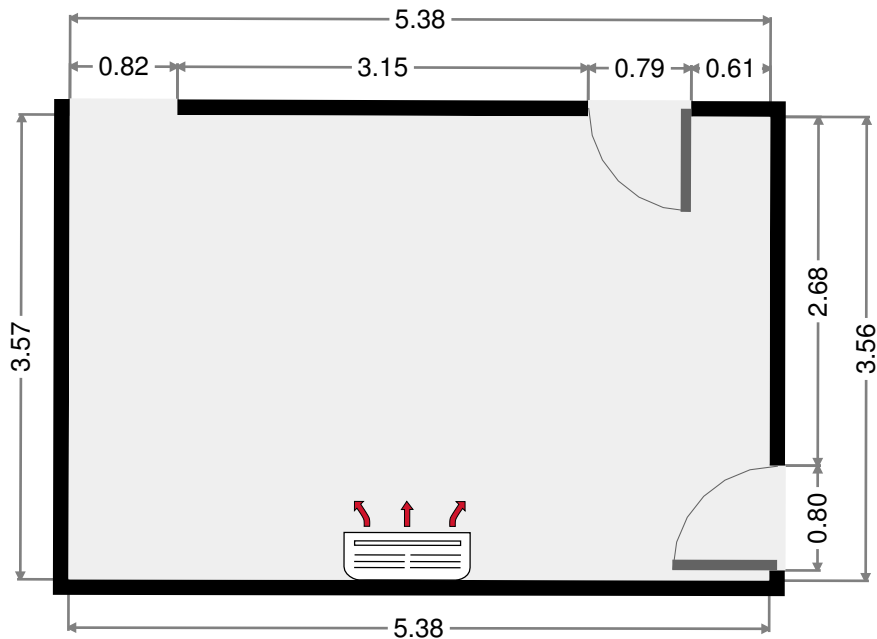
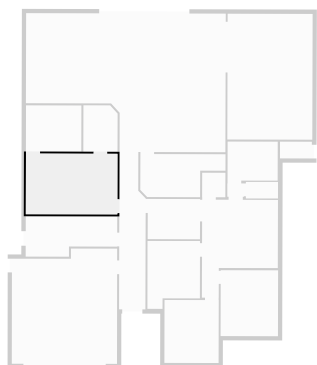

Hall

Width: 1.55 m
 Length: 3.54 m
 Area: 4.43 m²
 Perimeter: 9.91 m
 Ceiling Height: 2.17 m

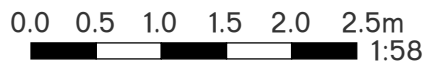
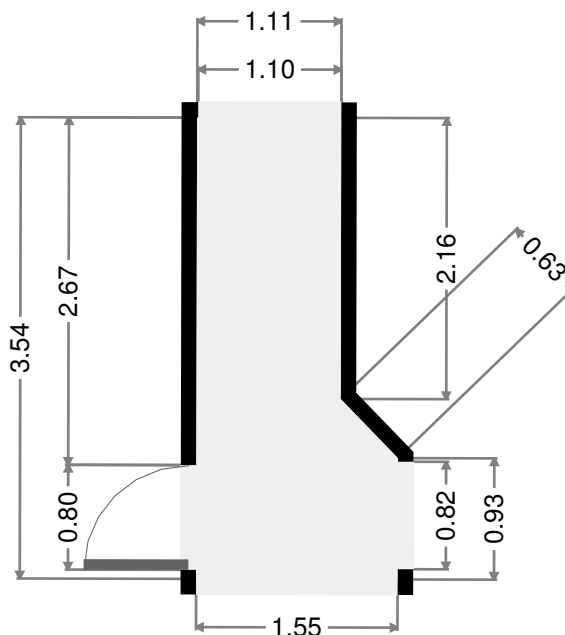
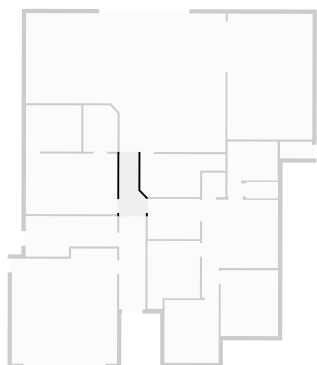

THIS FLOORPLAN IS PROVIDED WITHOUT WARRANTY OF ANY KIND. SENSOPIA DISCLAIMS ANY WARRANTY INCLUDING, WITHOUT LIMITATION, SATISFACTORY QUALITY OR ACCURACY OF DIMENSIONS.

- Width: 2.38 m
 Length: 5.38 m
 Area: 11.09 m²
 Perimeter: 15.51 m
 Ceiling Height: 2.17 m

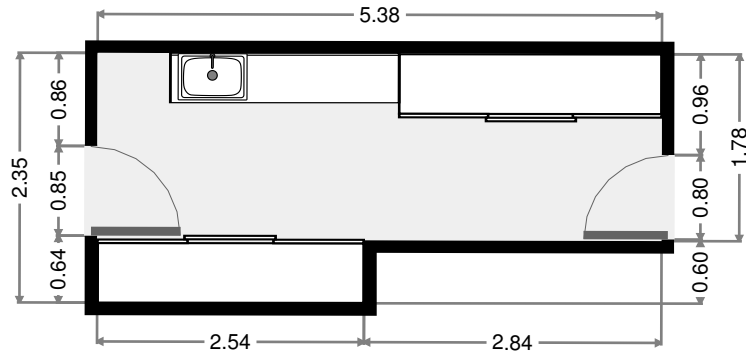
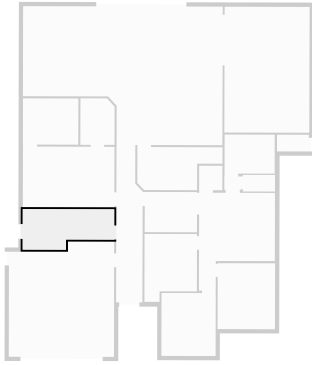

Garage

- Width: 6.18 m
 Length: 6.77 m
 Area: 39.78 m²
 Perimeter: 25.91 m
 Ceiling Height: 2.17 m

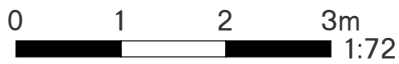
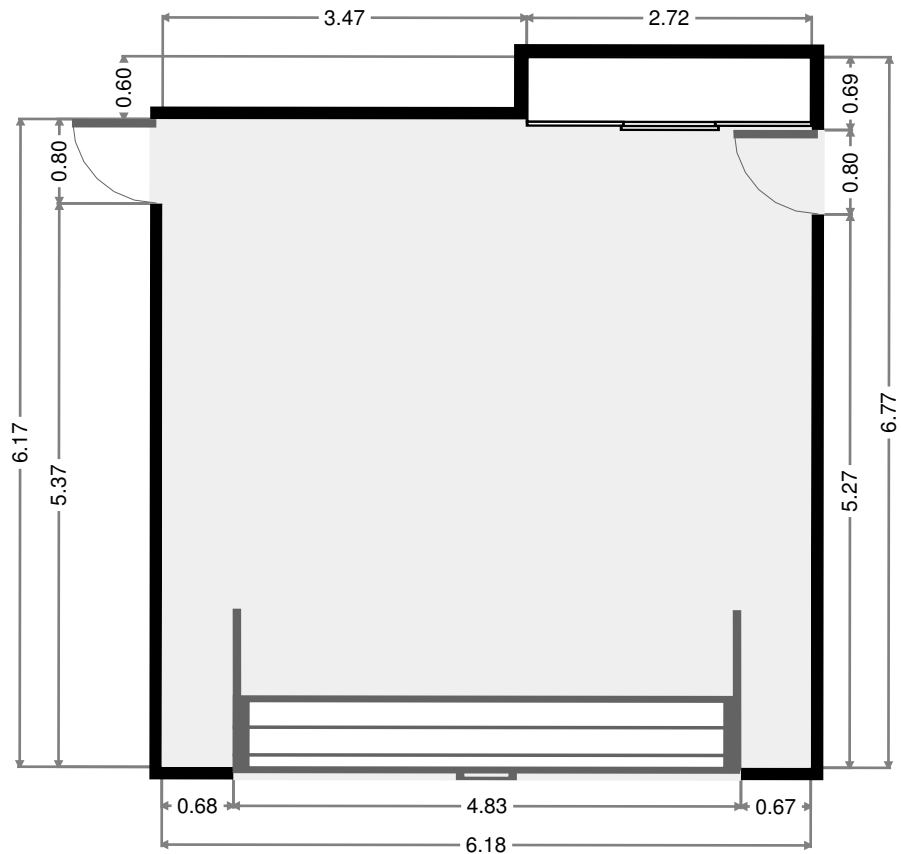
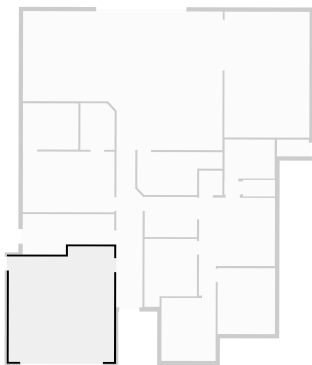

THIS FLOORPLAN IS PROVIDED WITHOUT WARRANTY OF ANY KIND. SENSOPIA DISCLAIMS ANY WARRANTY INCLUDING, WITHOUT LIMITATION, SATISFACTORY QUALITY OR ACCURACY OF DIMENSIONS.