

# 10 Kilkenny Court

## Ground Floor

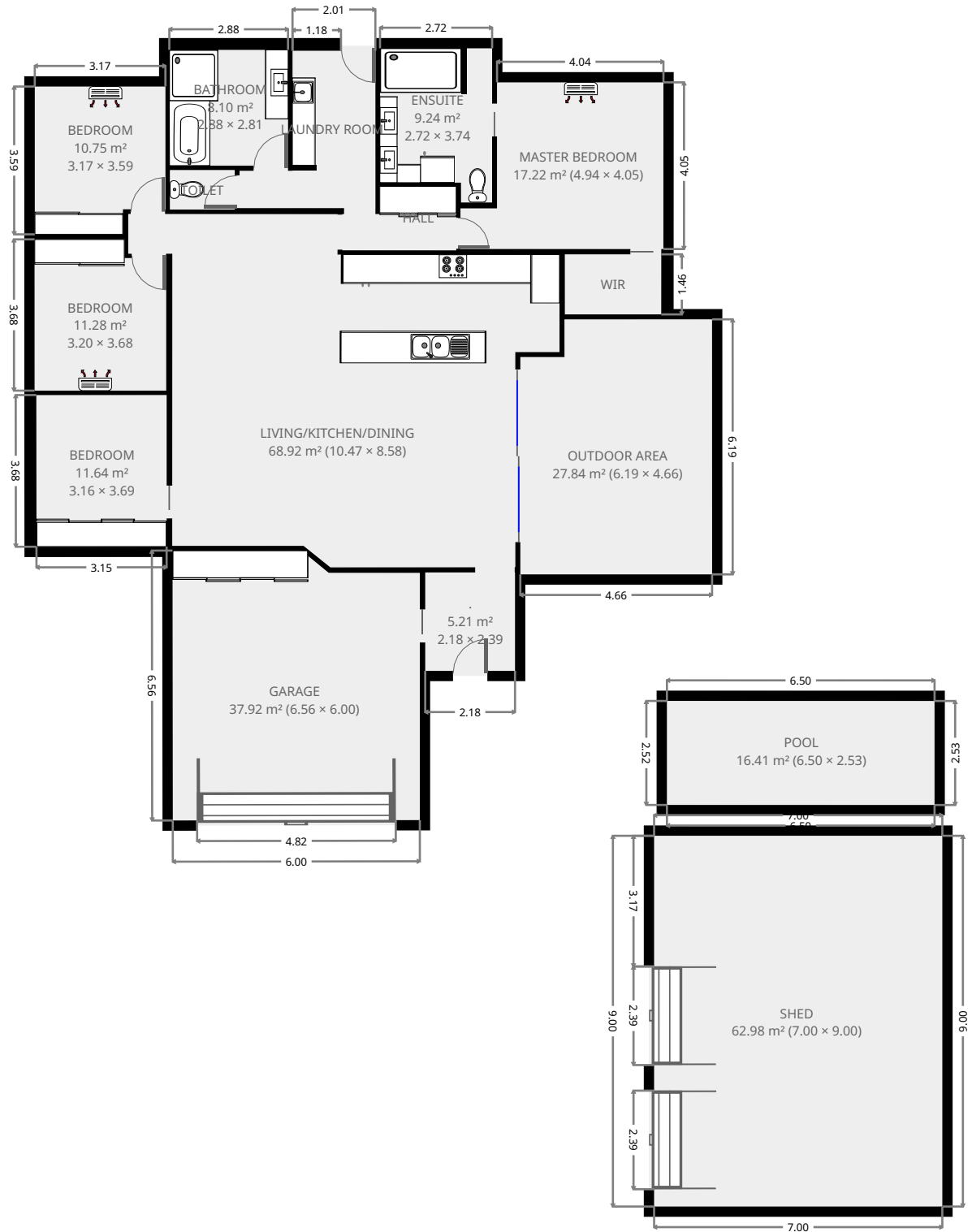

THIS FLOORPLAN IS PROVIDED WITHOUT WARRANTY OF ANY KIND. SENSOPIA DISCLAIMS ANY WARRANTY INCLUDING, WITHOUT LIMITATION, SATISFACTORY QUALITY OR ACCURACY OF DIMENSIONS.



# 10 Kilkenny Court

•  
 Width: 2.18 m  
 Length: 2.39 m  
 Area: 5.21 m<sup>2</sup>  
 Perimeter: 9.14 m

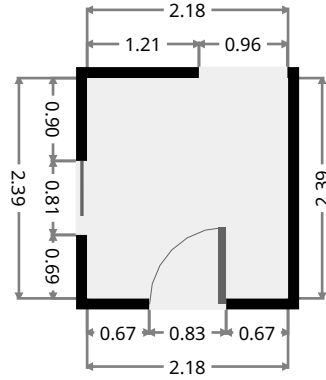
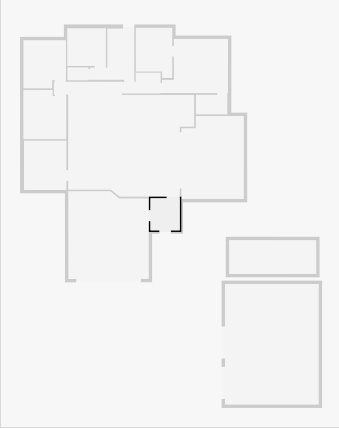

## Garage

Width: 6.00 m  
 Length: 6.56 m  
 Area: 37.92 m<sup>2</sup>  
 Perimeter: 24.75 m

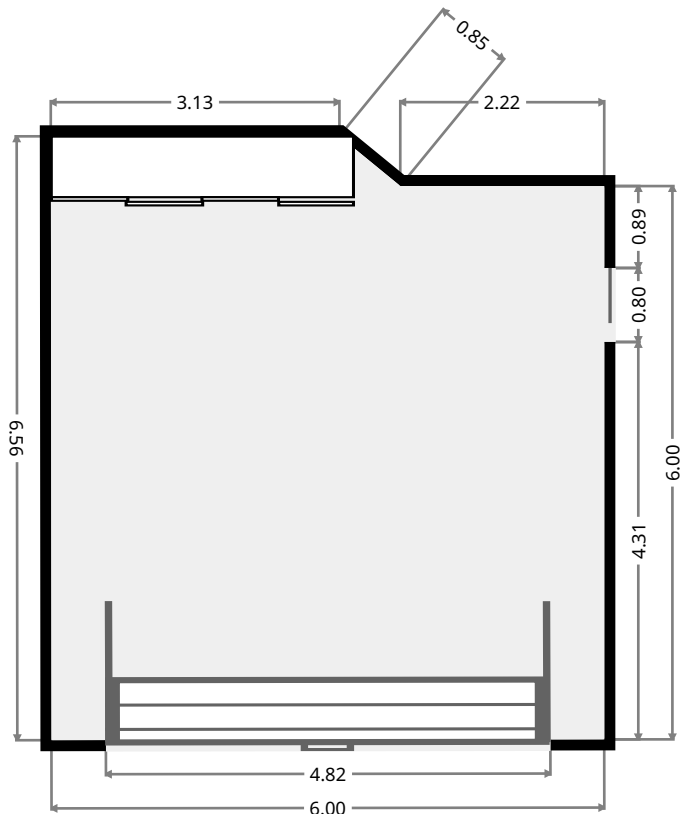
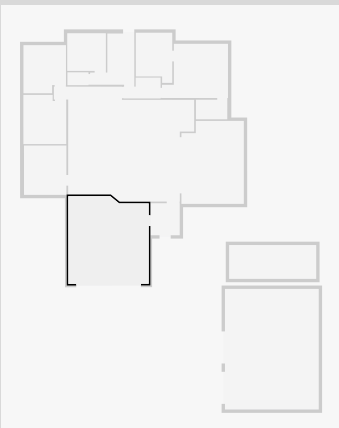

THIS FLOORPLAN IS PROVIDED WITHOUT WARRANTY OF ANY KIND. SENSOPIA DISCLAIMS ANY WARRANTY INCLUDING, WITHOUT LIMITATION, SATISFACTORY QUALITY OR ACCURACY OF DIMENSIONS.



# 10 Kilkenny Court

## Bedroom

Width: 3.16 m  
 Length: 3.69 m  
 Area: 11.64 m<sup>2</sup>  
 Perimeter: 13.69 m

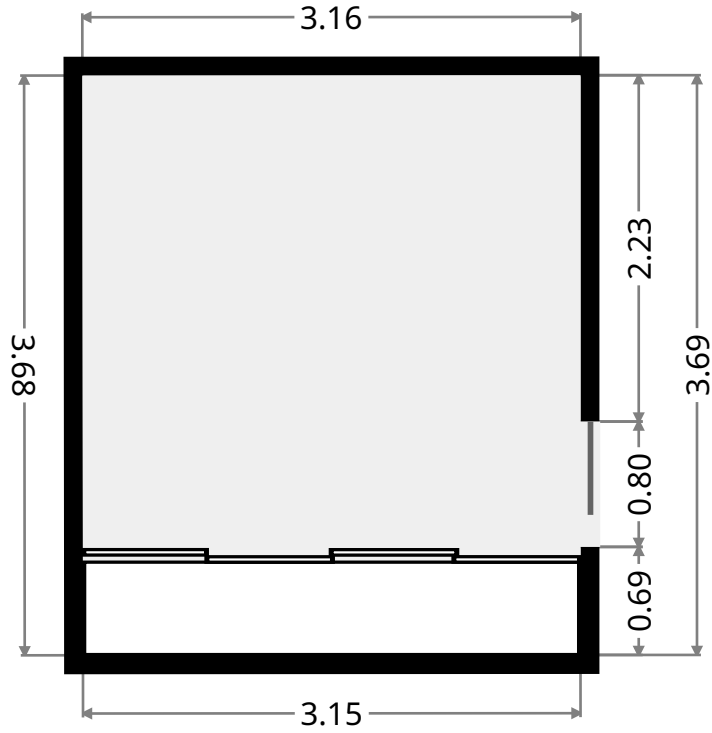
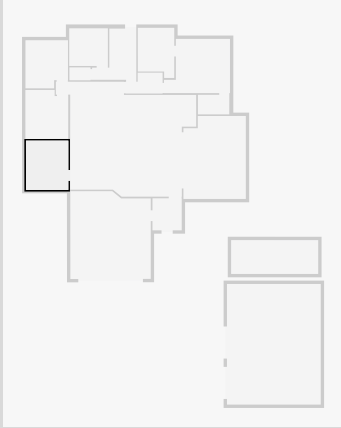

## Bedroom

Width: 3.17 m  
 Length: 3.59 m  
 Area: 10.75 m<sup>2</sup>  
 Perimeter: 13.52 m

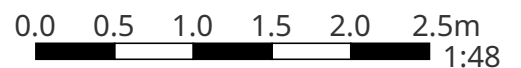
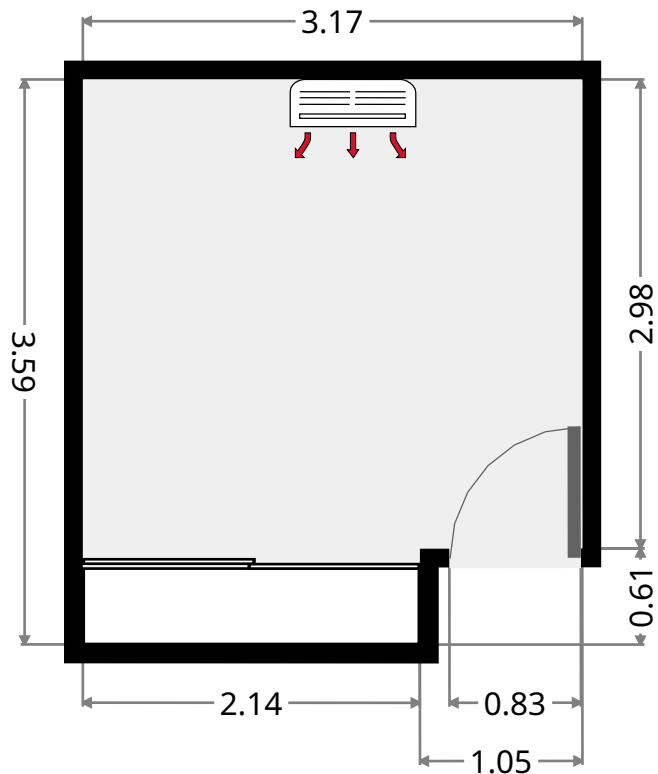
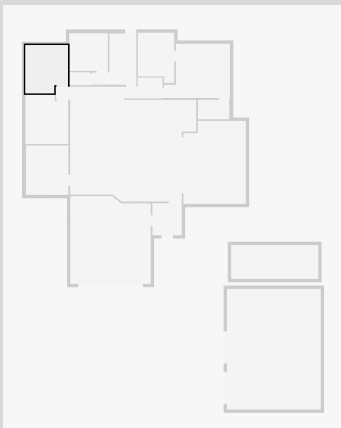

THIS FLOORPLAN IS PROVIDED WITHOUT WARRANTY OF ANY KIND. SENSOPIA DISCLAIMS ANY WARRANTY INCLUDING, WITHOUT LIMITATION, SATISFACTORY QUALITY OR ACCURACY OF DIMENSIONS.

# 10 Kilkenny Court

## Bedroom

Width: 3.20 m  
 Length: 3.68 m  
 Area: 11.28 m<sup>2</sup>  
 Perimeter: 13.74 m

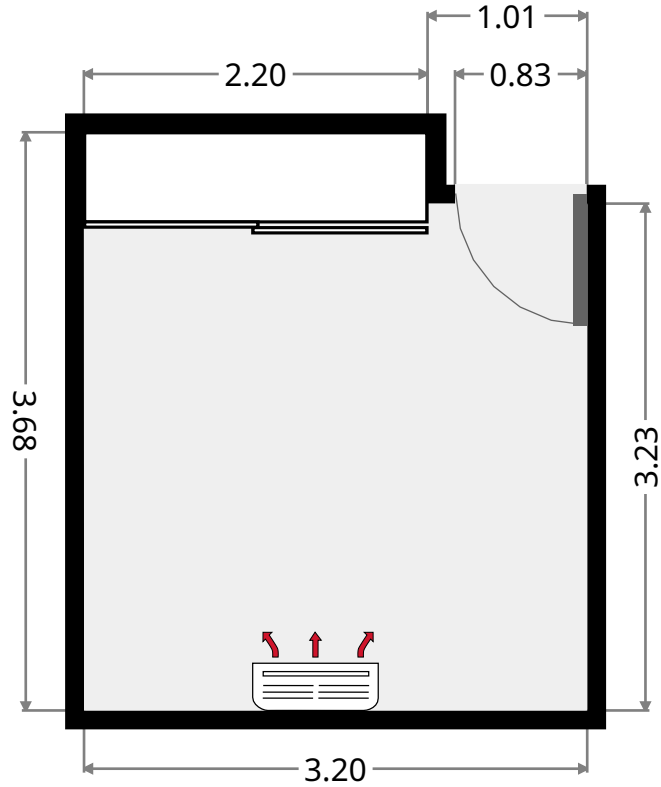
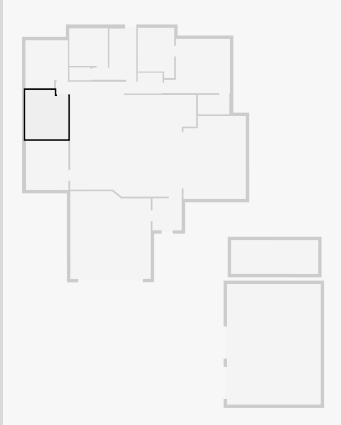

## Hall

Width: 1.57 m  
 Length: 2.77 m  
 Area: 3.69 m<sup>2</sup>  
 Perimeter: 8.64 m

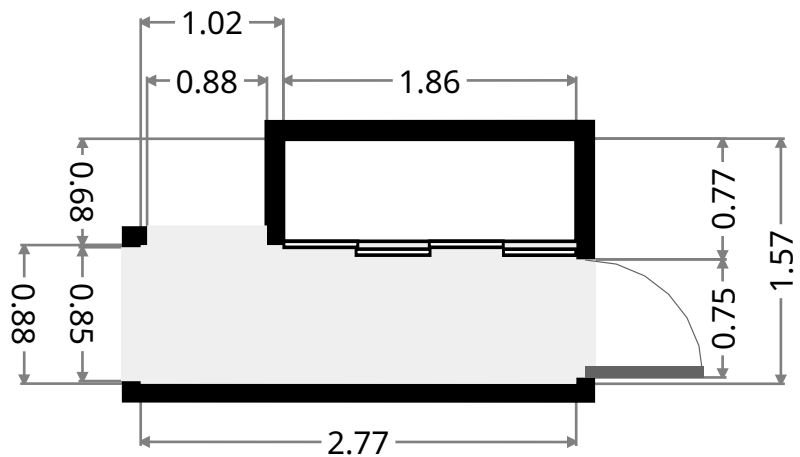
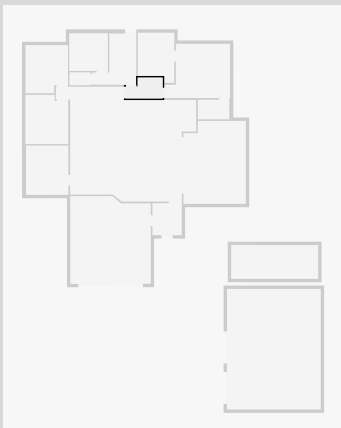

# 10 Kilkenny Court

## Master Bedroom

Width: 4.05 m  
 Length: 4.94 m  
 Area: 17.22 m<sup>2</sup>  
 Perimeter: 17.95 m

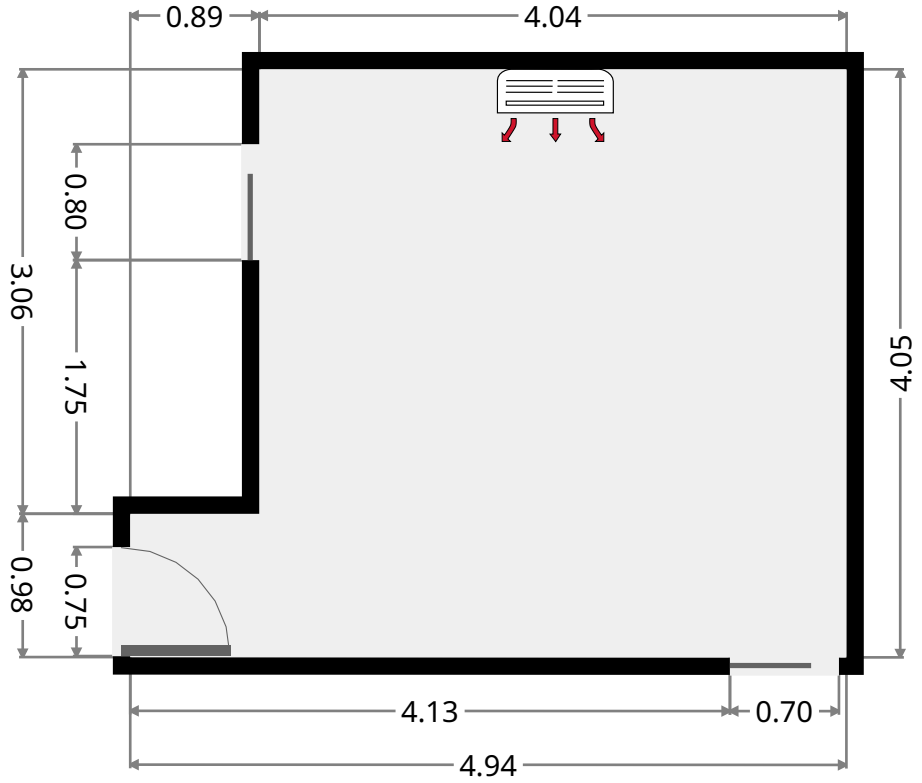
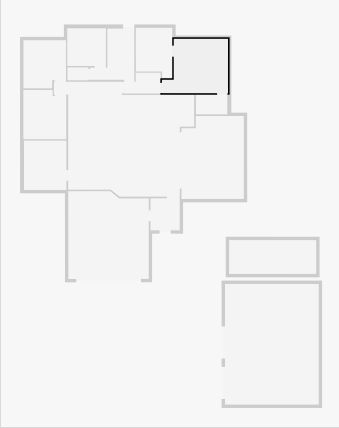

## WIR

Width: 1.46 m  
 Length: 2.34 m  
 Area: 3.41 m<sup>2</sup>  
 Perimeter: 7.60 m

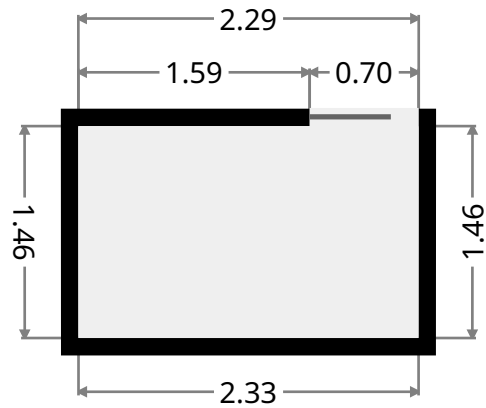
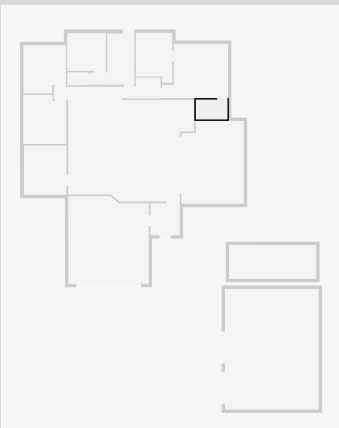

# 10 Kilkenny Court

## Ensuite

Width: 2.72 m  
 Length: 3.74 m  
 Area: 9.24 m<sup>2</sup>  
 Perimeter: 12.93 m

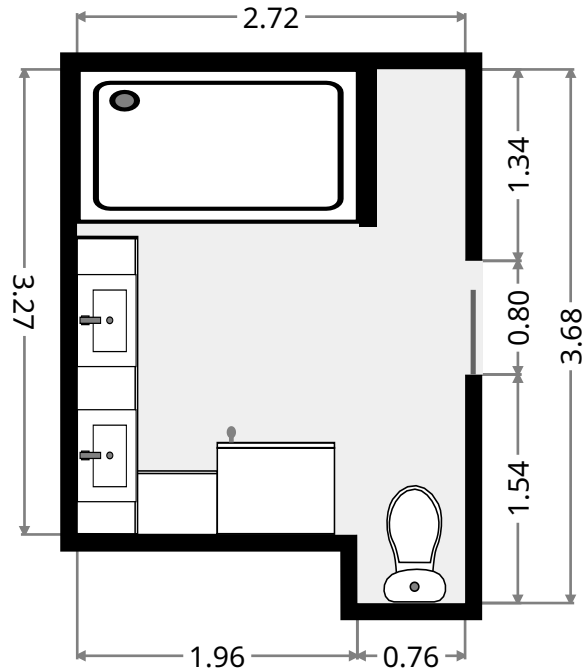
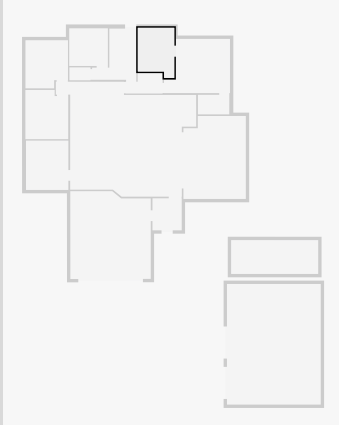

## Laundry Room

Width: 3.31 m  
 Length: 3.81 m  
 Area: 8.85 m<sup>2</sup>  
 Perimeter: 14.24 m

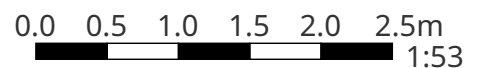
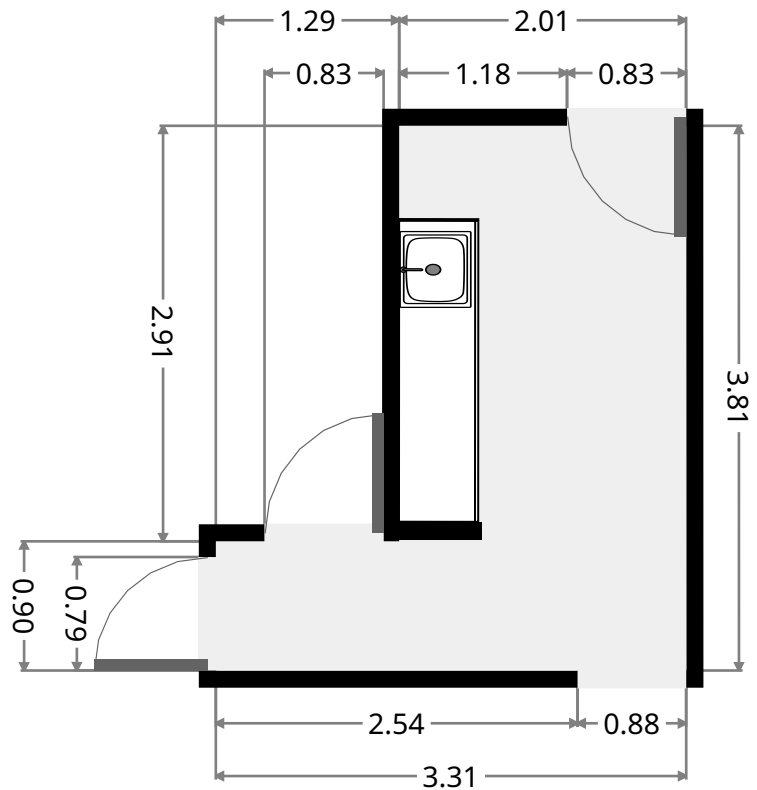
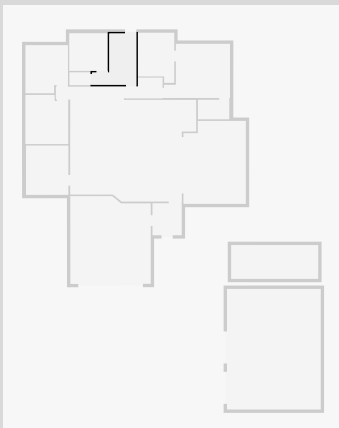

THIS FLOORPLAN IS PROVIDED WITHOUT WARRANTY OF ANY KIND. SENSOPIA DISCLAIMS ANY WARRANTY INCLUDING, WITHOUT LIMITATION, SATISFACTORY QUALITY OR ACCURACY OF DIMENSIONS.

# 10 Kilkenny Court

## Toilet

Width: 0.97 m  
Length: 1.57 m  
Area: 1.51 m<sup>2</sup>  
Perimeter: 5.07 m

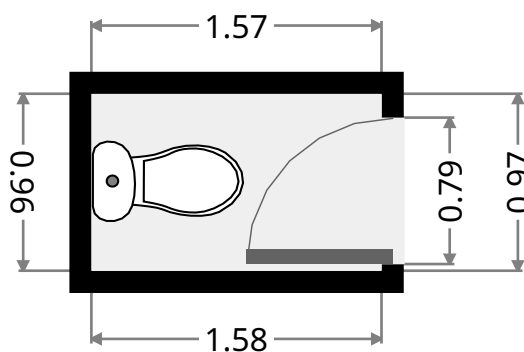
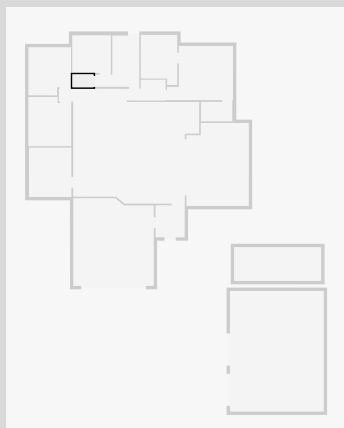

## Bathroom

Width: 2.81 m  
Length: 2.88 m  
Area: 8.10 m<sup>2</sup>  
Perimeter: 11.38 m

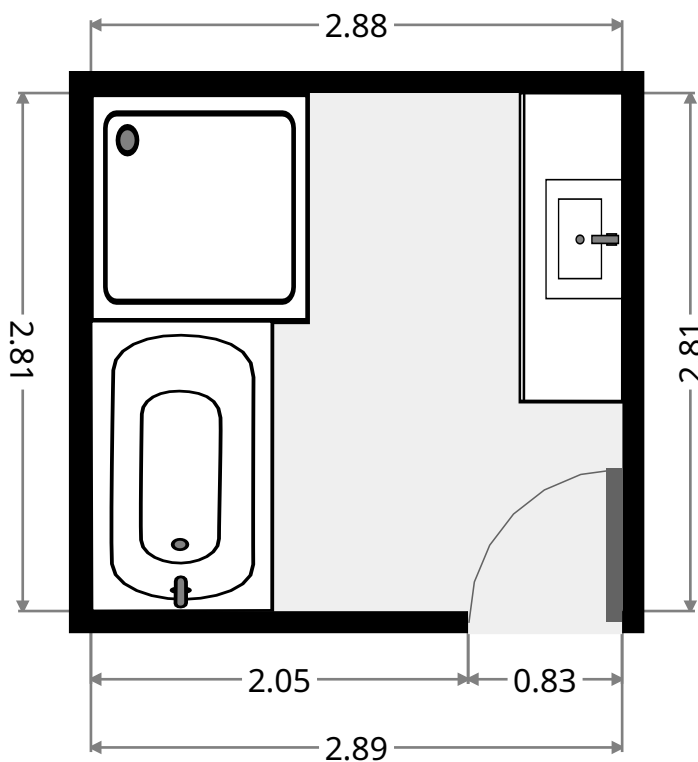
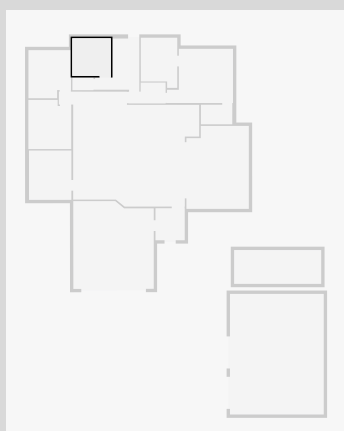



# 10 Kilkenny Court

## Outdoor Area

Width: 4.66 m  
Length: 6.19 m  
Area: 27.84 m<sup>2</sup>  
Perimeter: 21.69 m

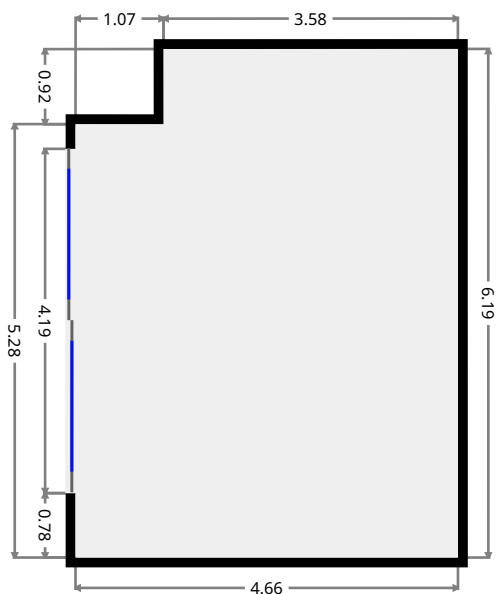
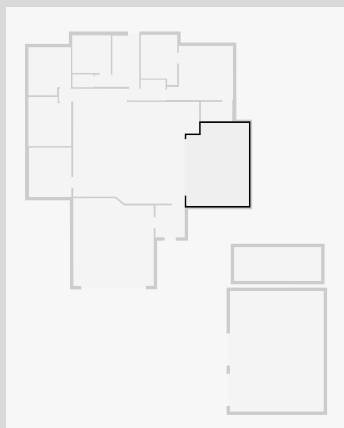

## Shed

Width: 7.00 m  
Length: 9.00 m  
Area: 62.98 m<sup>2</sup>  
Perimeter: 32.00 m

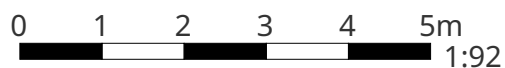
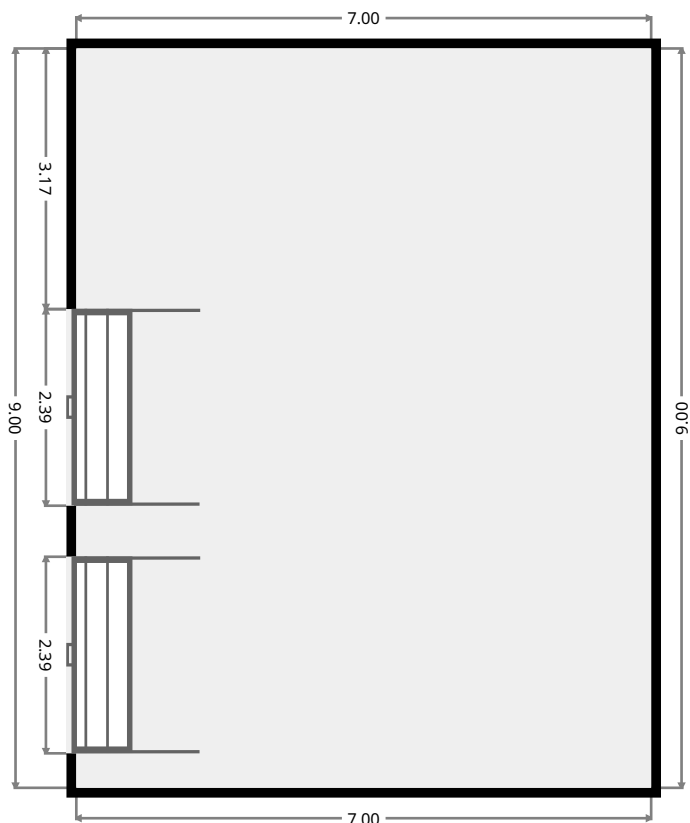
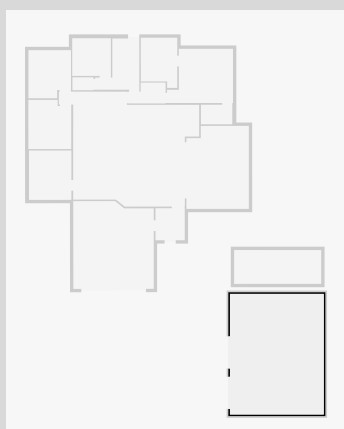

THIS FLOORPLAN IS PROVIDED WITHOUT WARRANTY OF ANY KIND. SENSOPIA DISCLAIMS ANY WARRANTY INCLUDING, WITHOUT LIMITATION, SATISFACTORY QUALITY OR ACCURACY OF DIMENSIONS.

# 10 Kilkenny Court

## Pool

Width: 2.53 m  
Length: 6.50 m  
Area: 16.41 m<sup>2</sup>  
Perimeter: 18.05 m

