

# Ground Floor

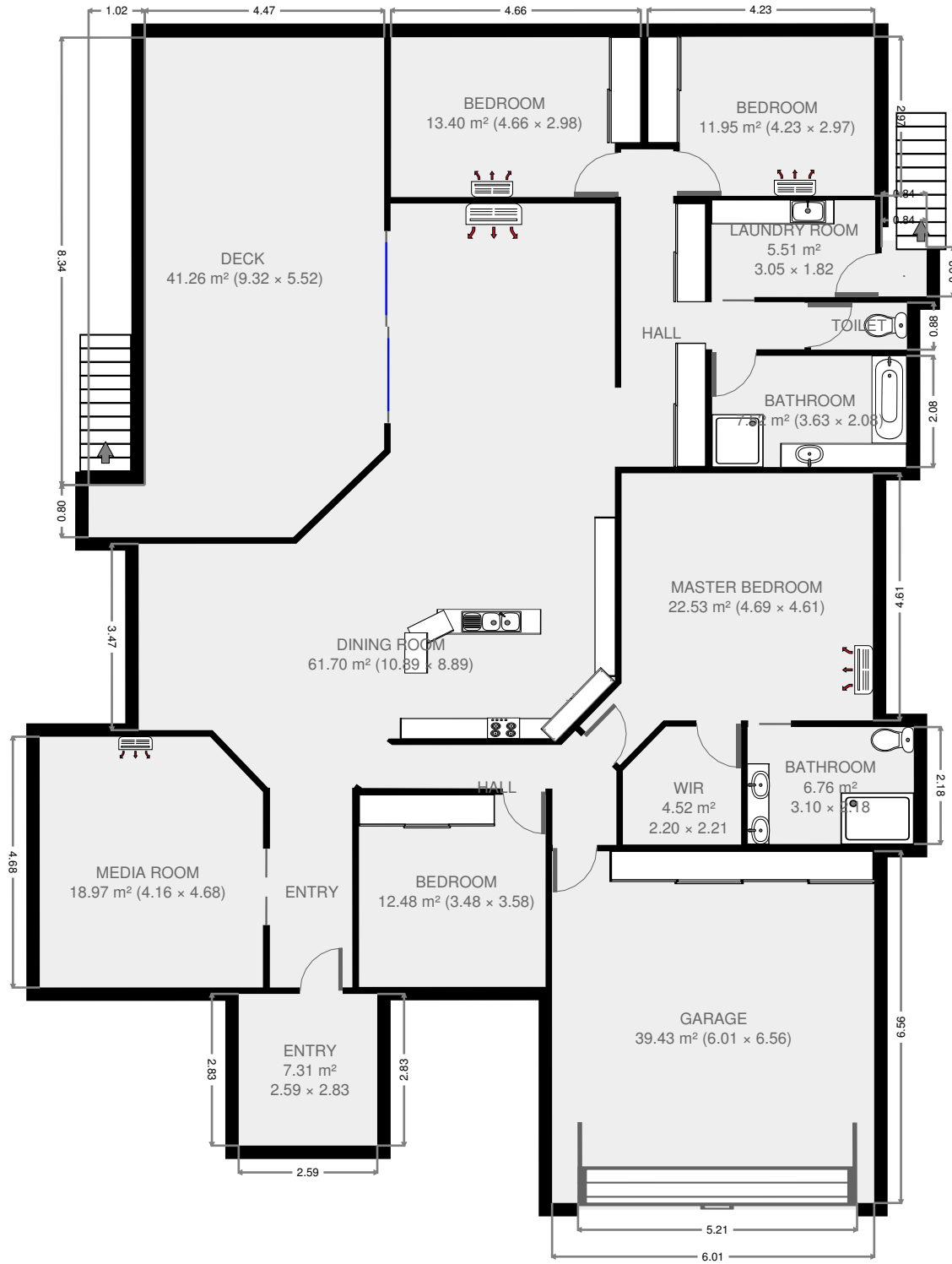

THIS FLOORPLAN IS PROVIDED WITHOUT WARRANTY OF ANY KIND. SENSOPIA DISCLAIMS ANY WARRANTY INCLUDING, WITHOUT LIMITATION, SATISFACTORY QUALITY OR ACCURACY OF DIMENSIONS.

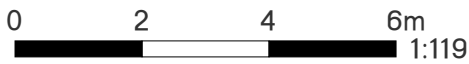

## 10 Haven Close

# Hall

Width: 3.42 m  
 Length: 5.92 m  
 Area: 10.34 m<sup>2</sup>  
 Perimeter: 18.68 m

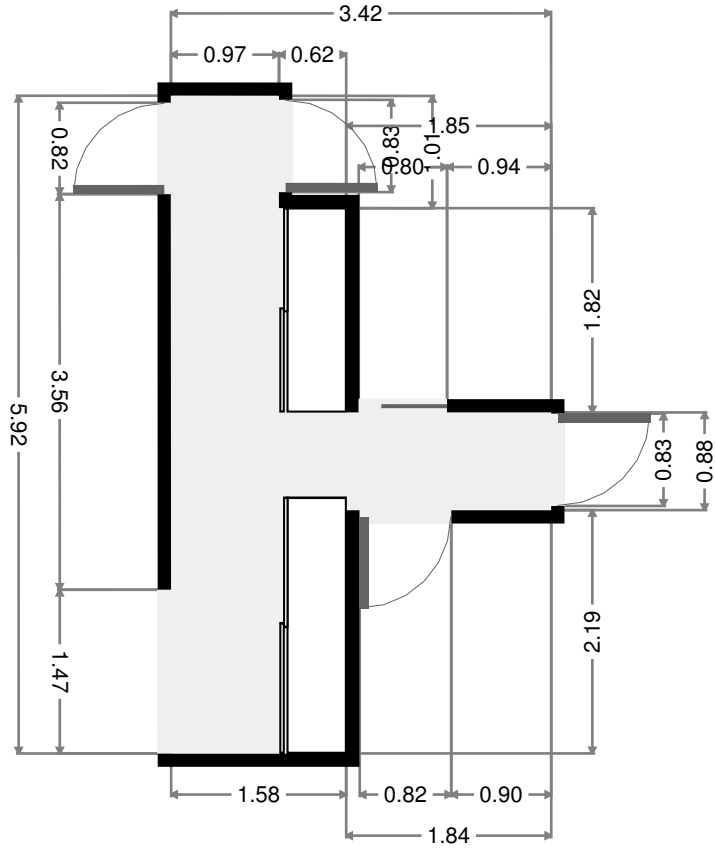
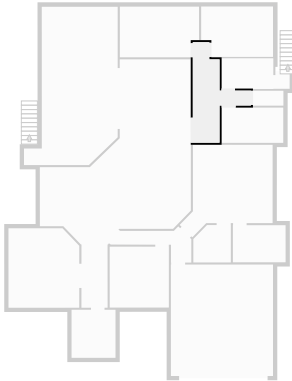

# Entry

Width: 2.59 m  
 Length: 2.83 m  
 Area: 7.31 m<sup>2</sup>  
 Perimeter: 10.83 m

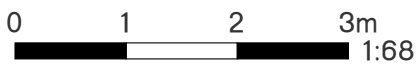
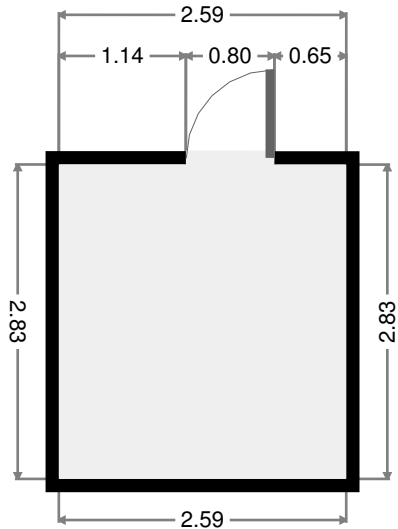
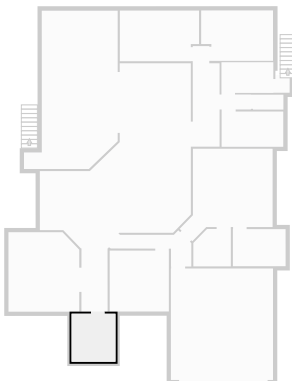

THIS FLOORPLAN IS PROVIDED WITHOUT WARRANTY OF ANY KIND. SENSOPIA DISCLAIMS ANY WARRANTY INCLUDING, WITHOUT LIMITATION, SATISFACTORY QUALITY OR ACCURACY OF DIMENSIONS.

# Deck

Width: 5.52 m  
 Length: 9.32 m  
 Area: 41.26 m<sup>2</sup>  
 Perimeter: 28.69 m

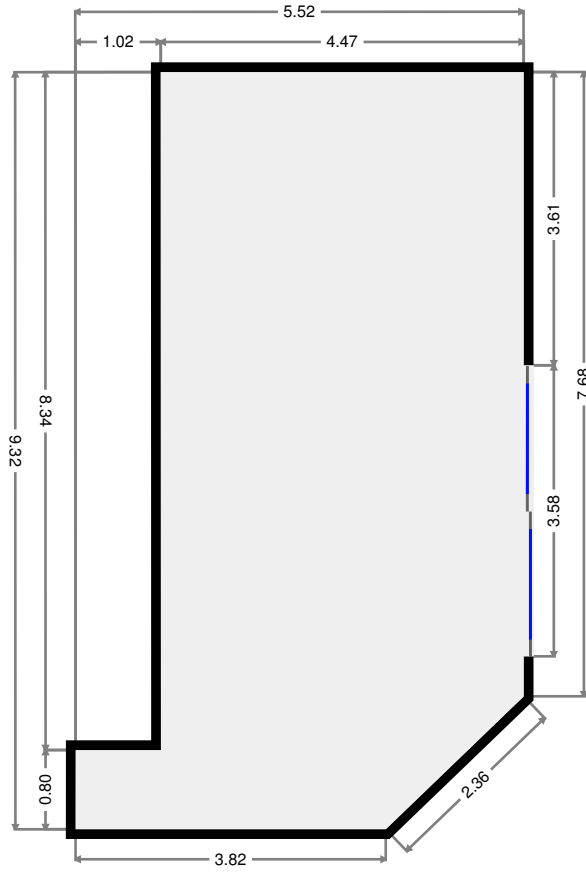
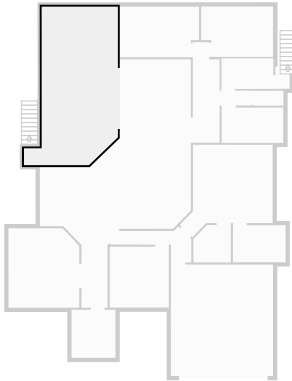

# Bedroom

Width: 2.97 m  
 Length: 4.23 m  
 Area: 11.95 m<sup>2</sup>  
 Perimeter: 14.39 m

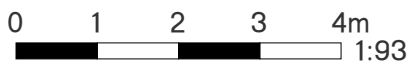
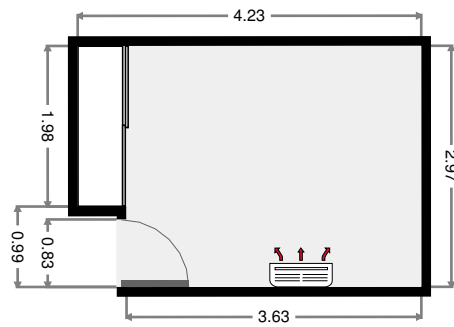
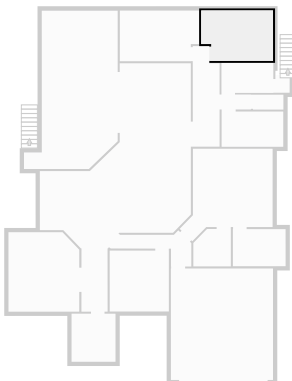

THIS FLOORPLAN IS PROVIDED WITHOUT WARRANTY OF ANY KIND. SENSOPIA DISCLAIMS ANY WARRANTY INCLUDING, WITHOUT LIMITATION, SATISFACTORY QUALITY OR ACCURACY OF DIMENSIONS.

# Bedroom

Width: 2.98 m  
 Length: 4.66 m  
 Area: 13.40 m<sup>2</sup>  
 Perimeter: 15.28 m

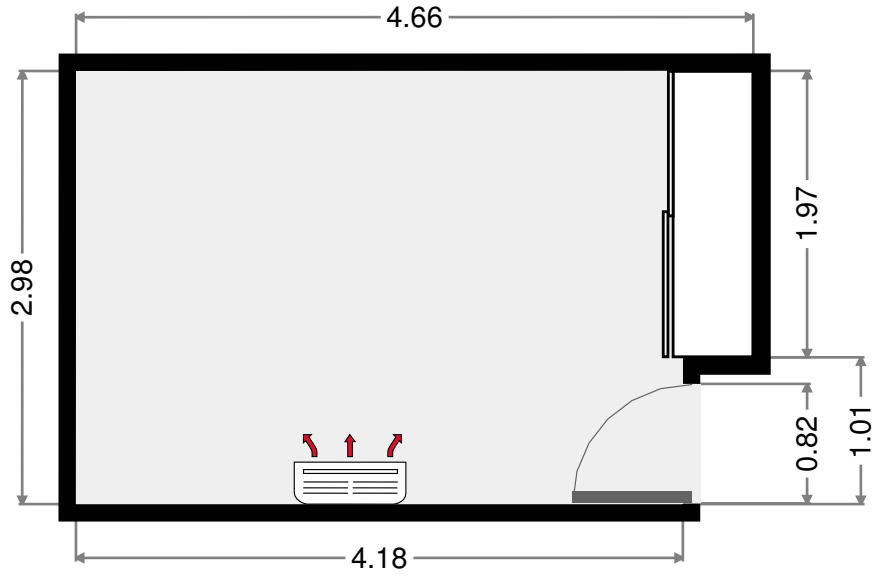
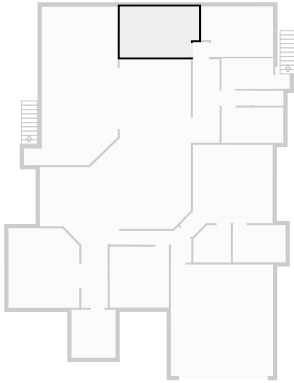

•  
 Width: 0.84 m  
 Length: 0.92 m  
 Area: 0.77 m<sup>2</sup>  
 Perimeter: 3.52 m

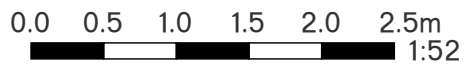
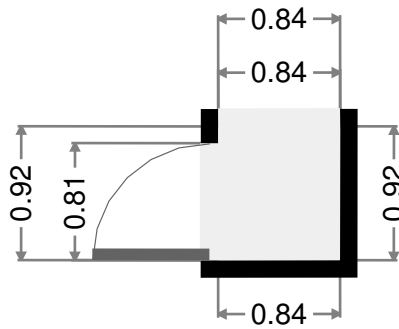
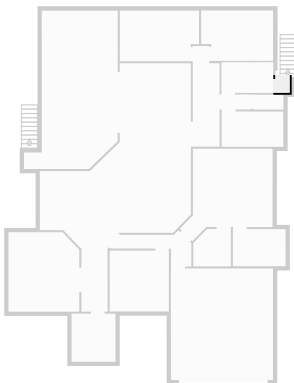

THIS FLOORPLAN IS PROVIDED WITHOUT WARRANTY OF ANY KIND. SENSOPIA DISCLAIMS ANY WARRANTY INCLUDING, WITHOUT LIMITATION, SATISFACTORY QUALITY OR ACCURACY OF DIMENSIONS.

# Laundry Room

Width: 1.82 m  
 Length: 3.05 m  
 Area: 5.51 m<sup>2</sup>  
 Perimeter: 9.71 m

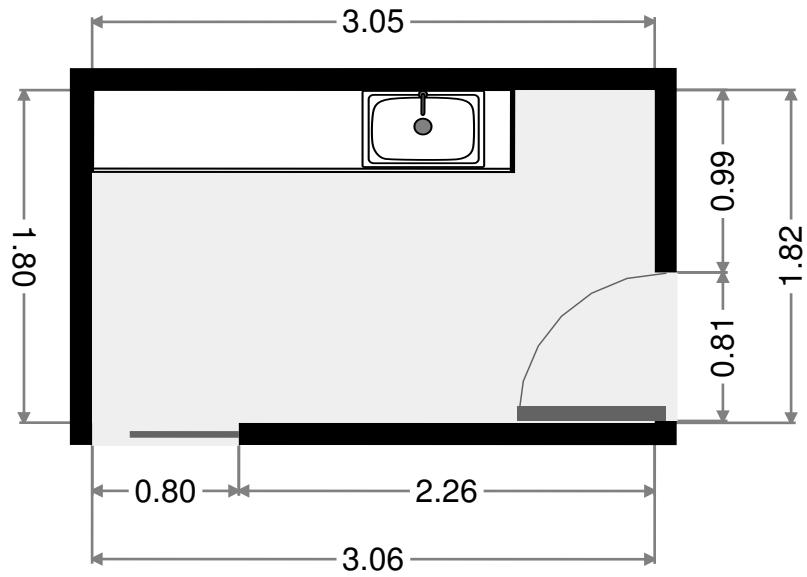

# Bathroom

Width: 2.08 m  
 Length: 3.63 m  
 Area: 7.52 m<sup>2</sup>  
 Perimeter: 11.40 m

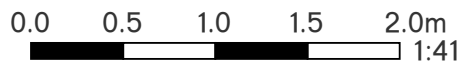
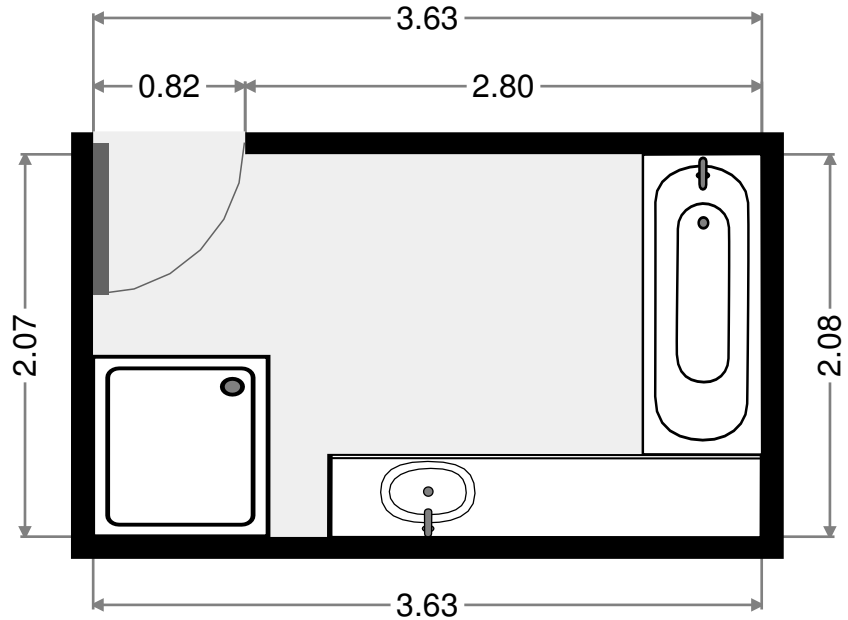
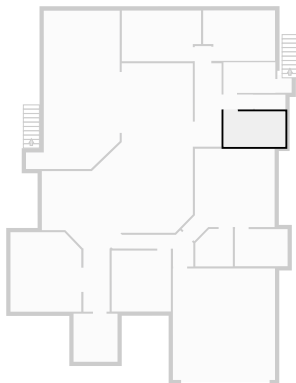

THIS FLOORPLAN IS PROVIDED WITHOUT WARRANTY OF ANY KIND. SENSOPIA DISCLAIMS ANY WARRANTY INCLUDING, WITHOUT LIMITATION, SATISFACTORY QUALITY OR ACCURACY OF DIMENSIONS.

# Toilet

Width: 0.88 m  
Length: 1.79 m  
Area: 1.57 m<sup>2</sup>  
Perimeter: 5.33 m

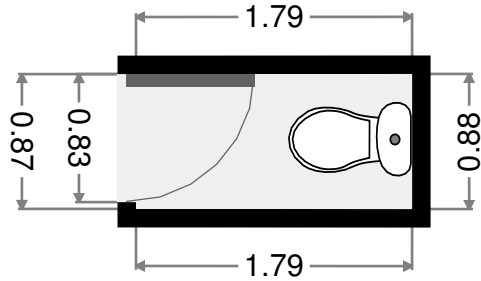
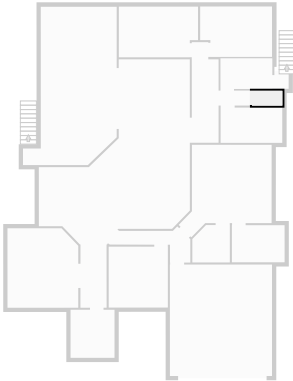

# Entry

Width: 1.53 m  
Length: 3.60 m  
Area: 5.54 m<sup>2</sup>  
Perimeter: 10.28 m

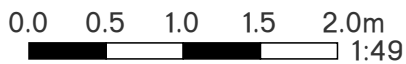
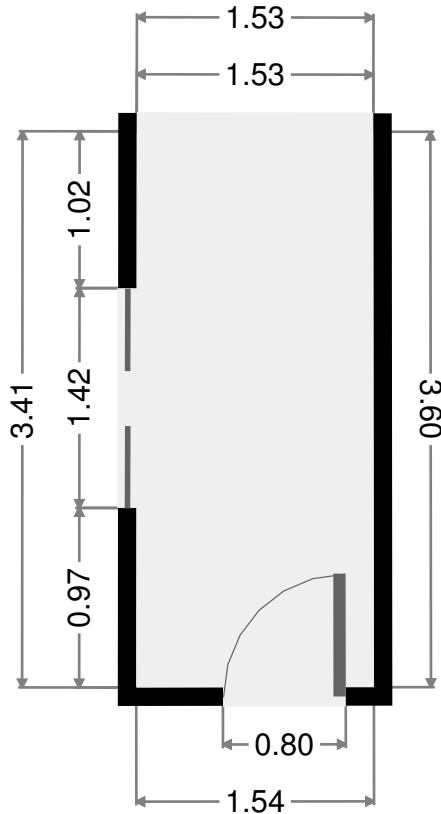
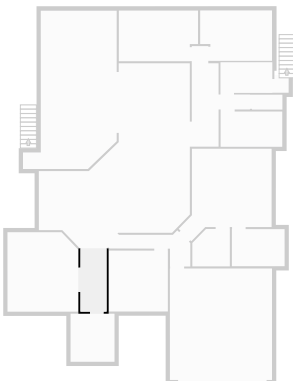

THIS FLOORPLAN IS PROVIDED WITHOUT WARRANTY OF ANY KIND. SENSOPIA DISCLAIMS ANY WARRANTY INCLUDING, WITHOUT LIMITATION, SATISFACTORY QUALITY OR ACCURACY OF DIMENSIONS.

# Dining Room

Width: 8.89 m  
 Length: 10.89 m  
 Area: 61.70 m<sup>2</sup>  
 Perimeter: 36.87 m  
 Ceiling Height: 2.17 m

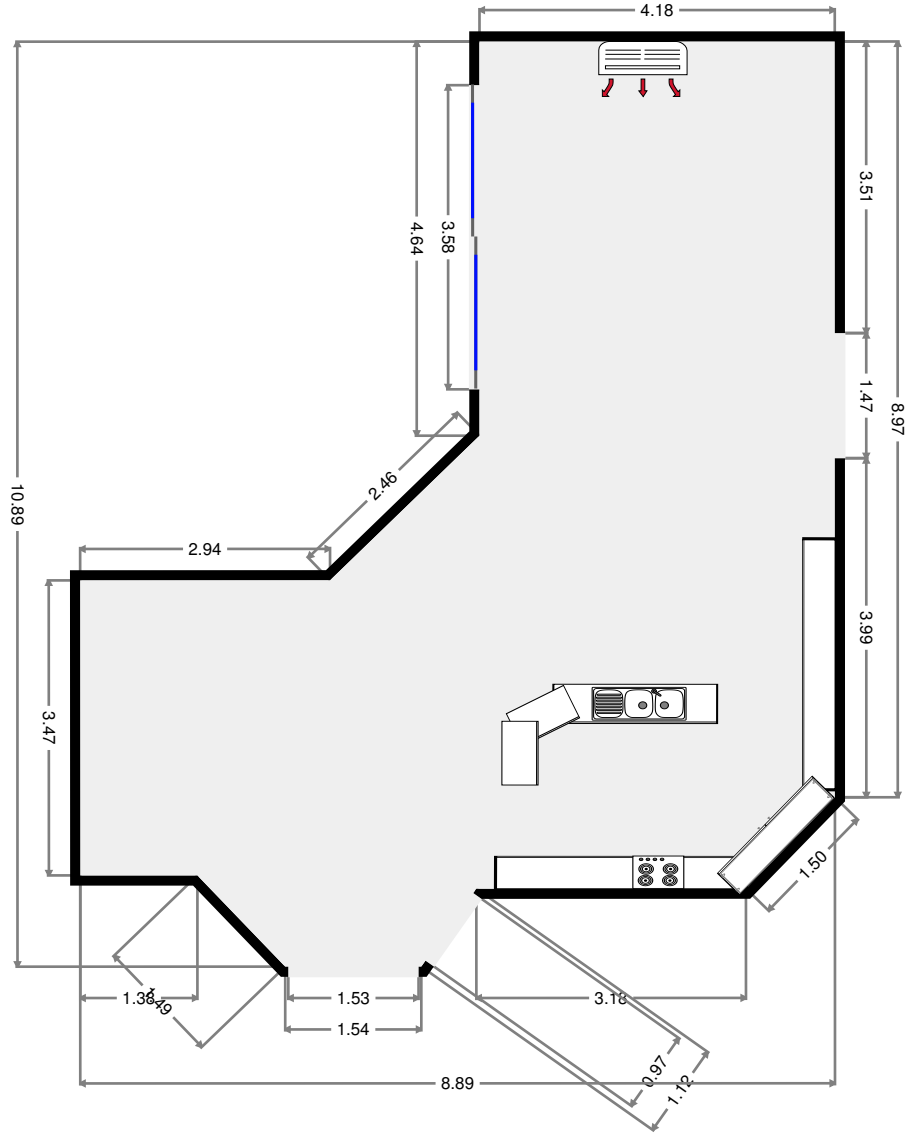
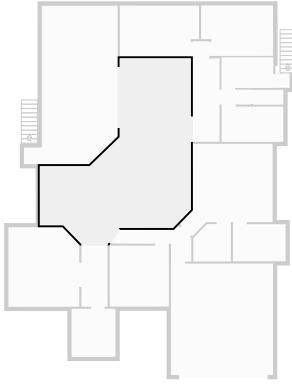

THIS FLOORPLAN IS PROVIDED WITHOUT WARRANTY OF ANY KIND. SENSOPIA DISCLAIMS ANY WARRANTY INCLUDING, WITHOUT LIMITATION, SATISFACTORY QUALITY OR ACCURACY OF DIMENSIONS.

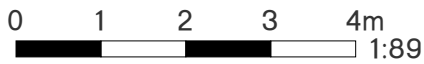

# Garage

Width: 6.01 m  
 Length: 6.56 m  
 Area: 39.43 m<sup>2</sup>  
 Perimeter: 25.14 m

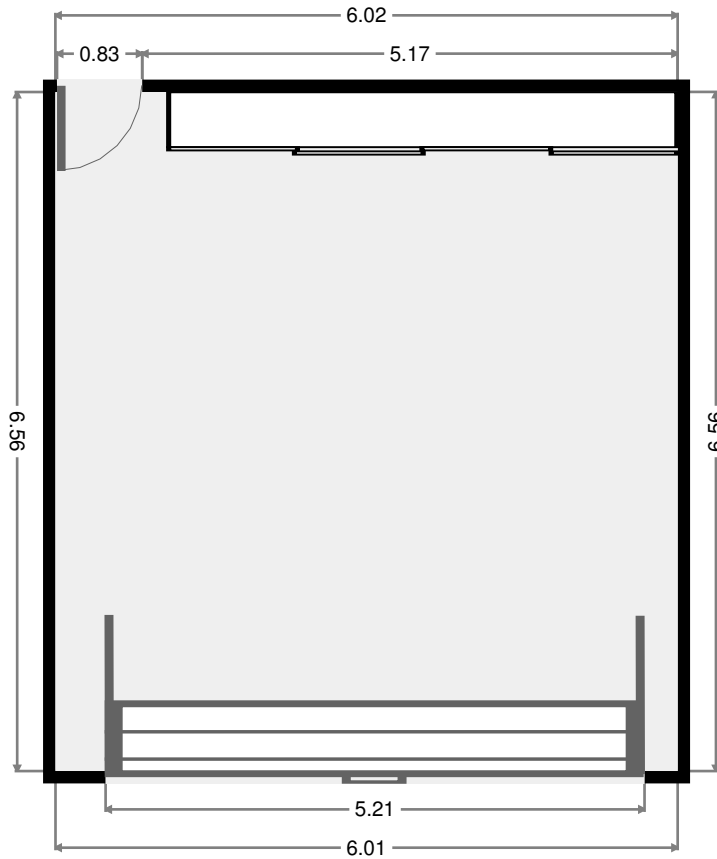
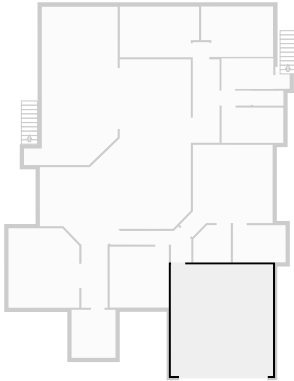

# WIR

Width: 2.20 m  
 Length: 2.21 m  
 Area: 4.52 m<sup>2</sup>  
 Perimeter: 8.33 m

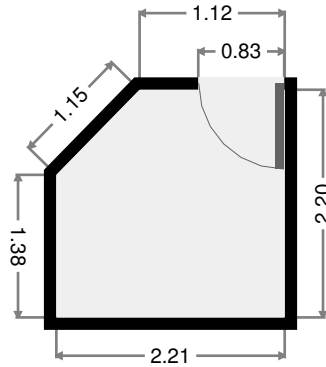
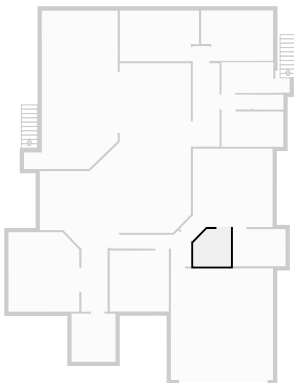

THIS FLOORPLAN IS PROVIDED WITHOUT WARRANTY OF ANY KIND. SENSOPIA DISCLAIMS ANY WARRANTY INCLUDING, WITHOUT LIMITATION, SATISFACTORY QUALITY OR ACCURACY OF DIMENSIONS.



# Bathroom

Width: 2.18 m  
 Length: 3.10 m  
 Area: 6.76 m<sup>2</sup>  
 Perimeter: 10.57 m

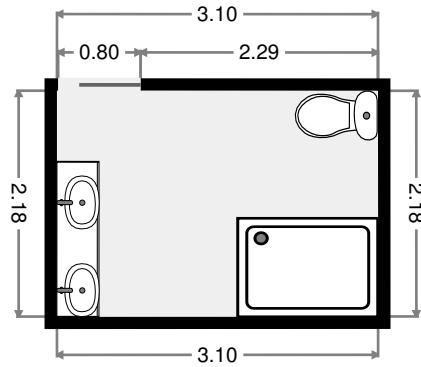
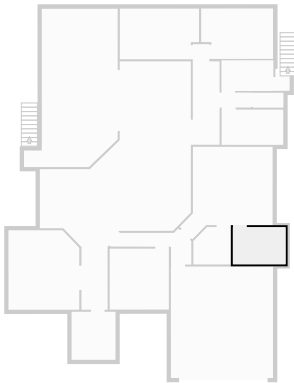

# Master Bedroom

Width: 4.61 m  
 Length: 4.69 m  
 Area: 22.53 m<sup>2</sup>  
 Perimeter: 20.44 m  
 Ceiling Height: 2.17 m

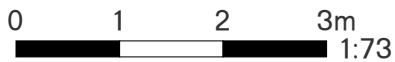
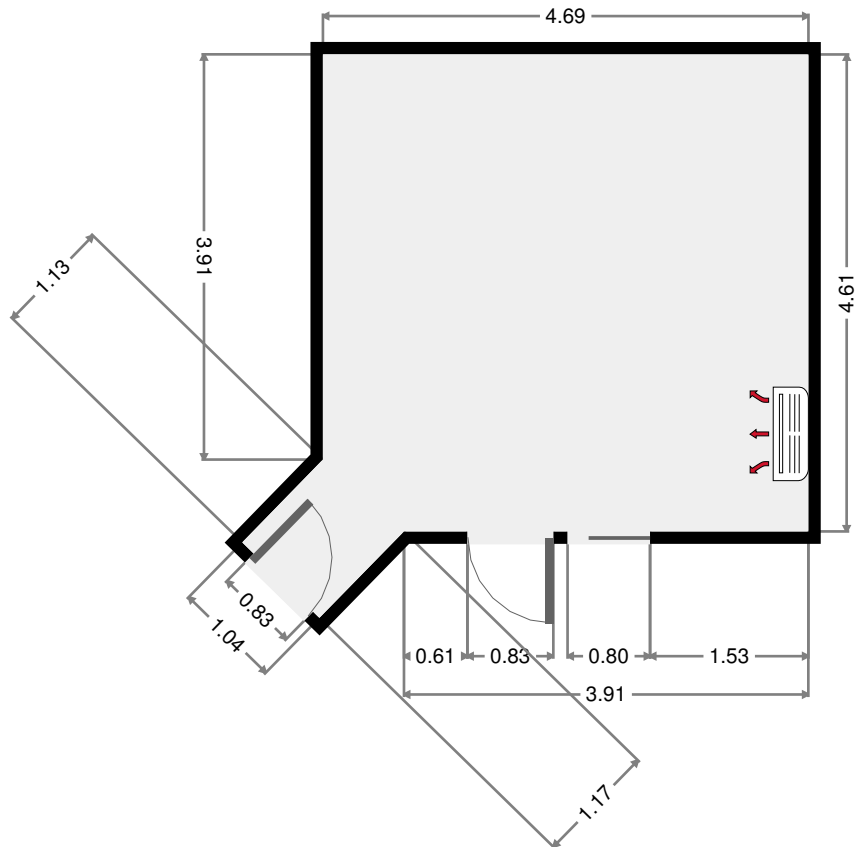
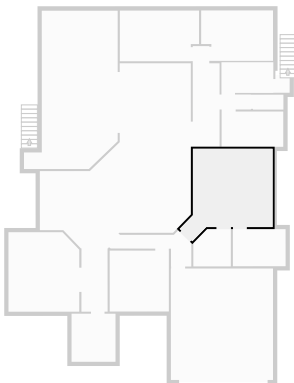

THIS FLOORPLAN IS PROVIDED WITHOUT WARRANTY OF ANY KIND. SENSOPIA DISCLAIMS ANY WARRANTY INCLUDING, WITHOUT LIMITATION, SATISFACTORY QUALITY OR ACCURACY OF DIMENSIONS.

# Bedroom

Width: 3.48 m  
 Length: 3.58 m  
 Area: 12.48 m<sup>2</sup>  
 Perimeter: 14.13 m

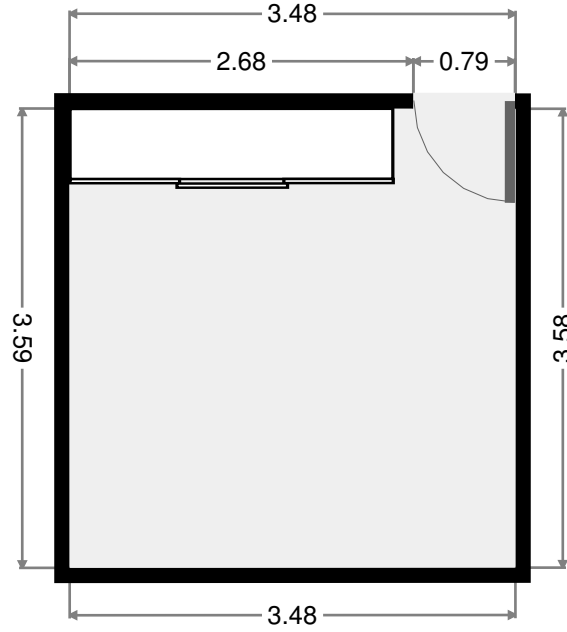
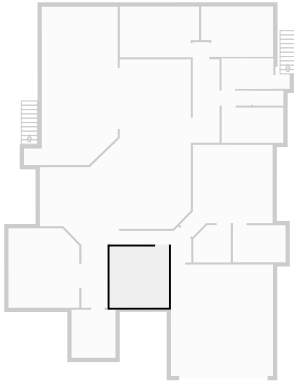

# Hall

Width: 1.86 m  
 Length: 4.76 m  
 Area: 4.82 m<sup>2</sup>  
 Perimeter: 12.77 m

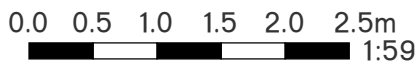
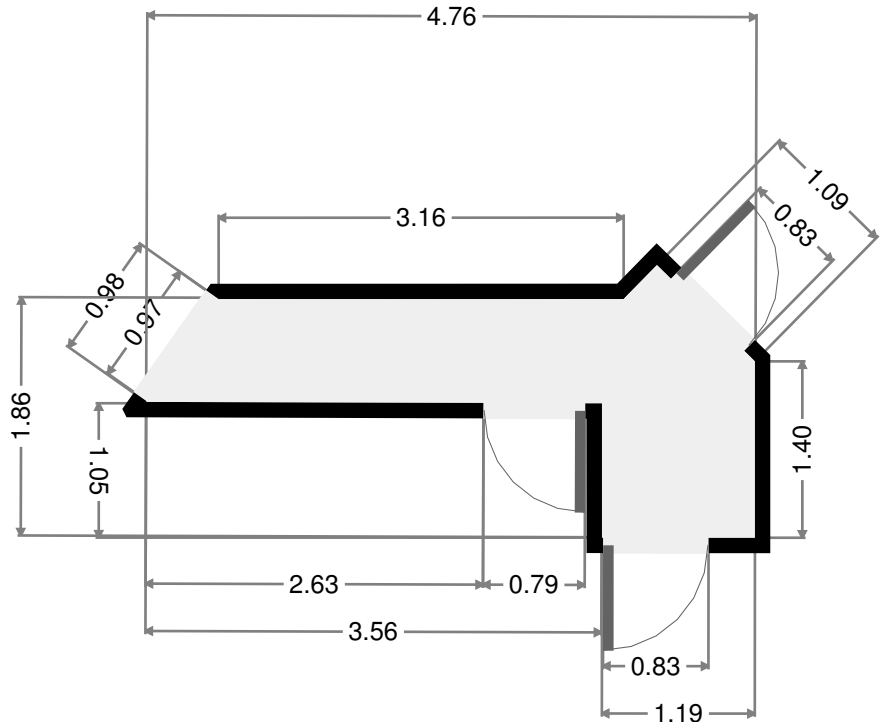
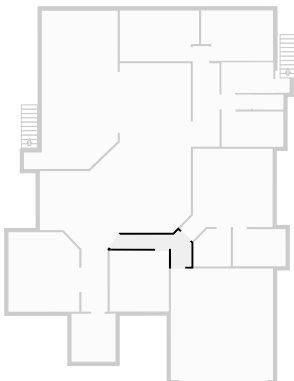

THIS FLOORPLAN IS PROVIDED WITHOUT WARRANTY OF ANY KIND. SENSOPIA DISCLAIMS ANY WARRANTY INCLUDING, WITHOUT LIMITATION, SATISFACTORY QUALITY OR ACCURACY OF DIMENSIONS.

# Media Room

Width: 4.16 m  
Length: 4.68 m  
Area: 18.97 m<sup>2</sup>  
Perimeter: 17.09 m  
Ceiling Height: 2.17 m

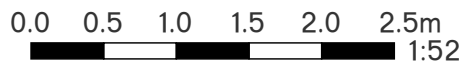
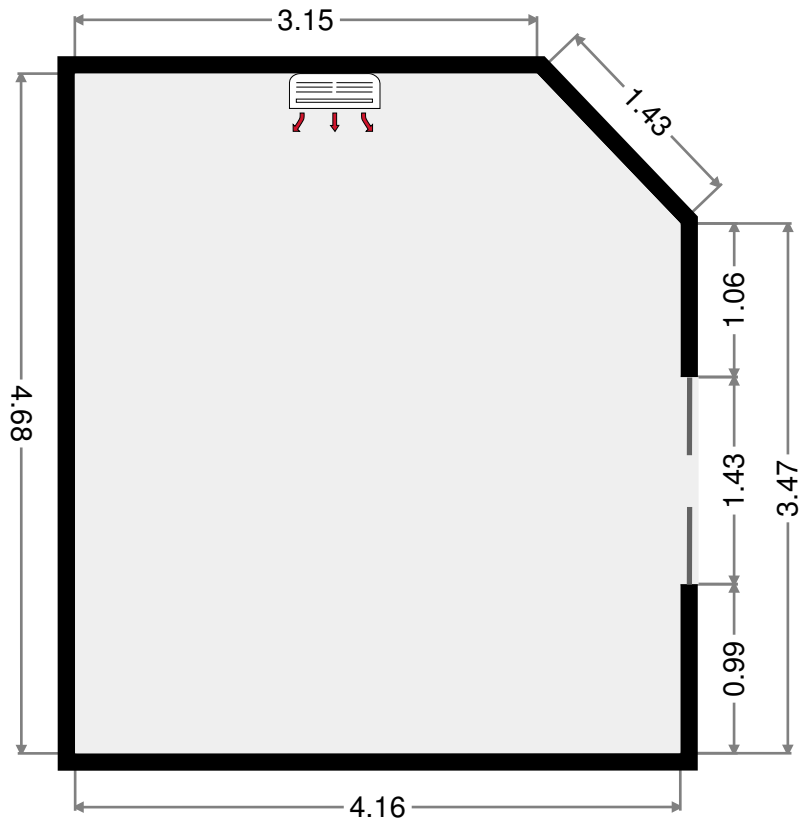
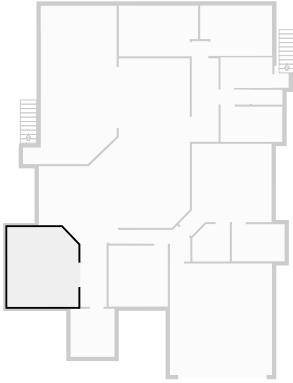

THIS FLOORPLAN IS PROVIDED WITHOUT WARRANTY OF ANY KIND. SENSOPIA DISCLAIMS ANY WARRANTY INCLUDING, WITHOUT LIMITATION, SATISFACTORY QUALITY OR ACCURACY OF DIMENSIONS.

# Basement

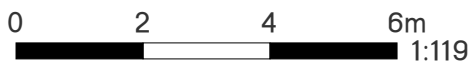
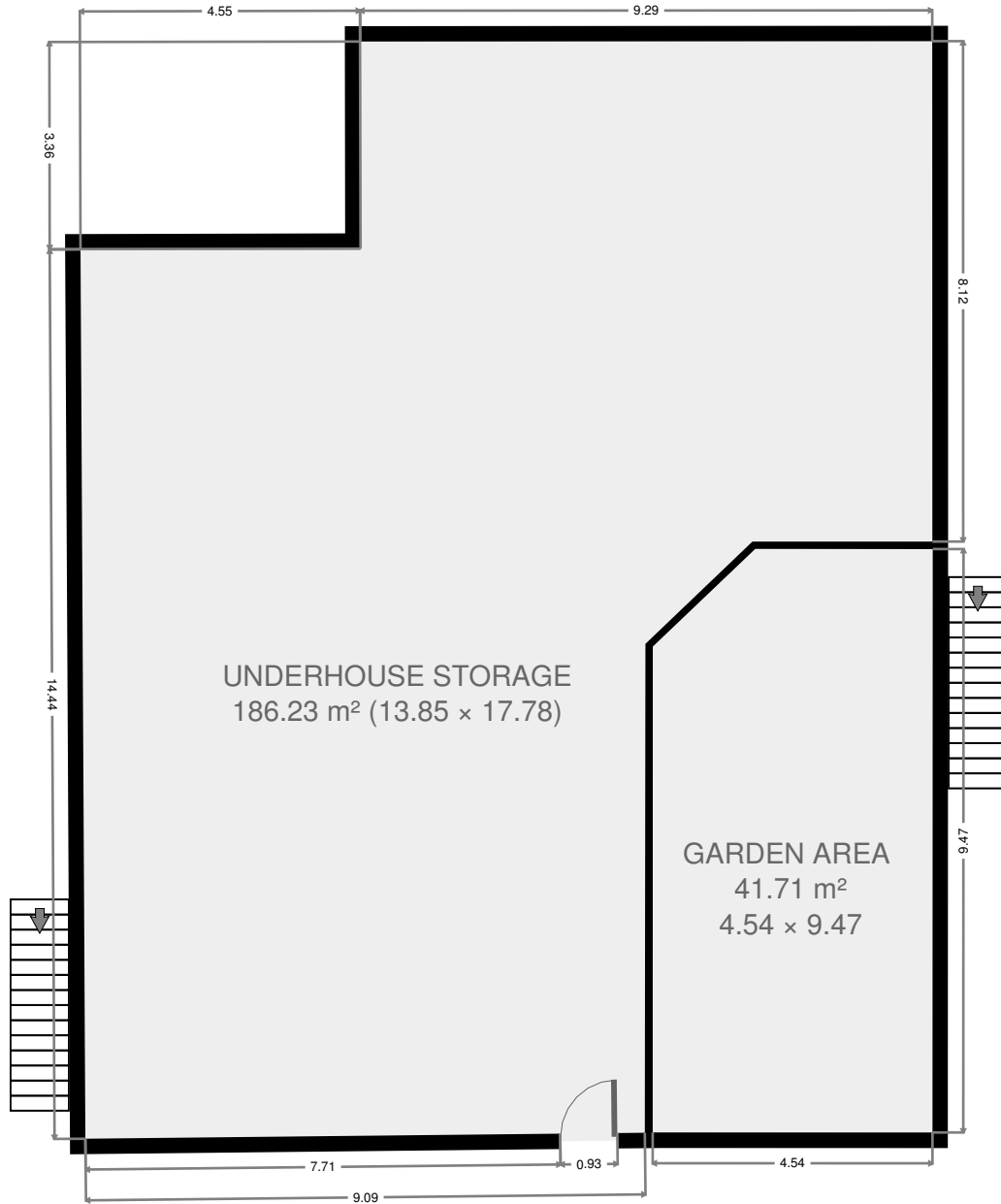

THIS FLOORPLAN IS PROVIDED WITHOUT WARRANTY OF ANY KIND. SENSOPIA DISCLAIMS ANY WARRANTY INCLUDING, WITHOUT LIMITATION, SATISFACTORY QUALITY OR ACCURACY OF DIMENSIONS.

## 10 Haven Close

# Underhouse Storage

Width: 13.85 m  
Length: 17.78 m  
Area: 186.23 m<sup>2</sup>  
Perimeter: 62.09 m

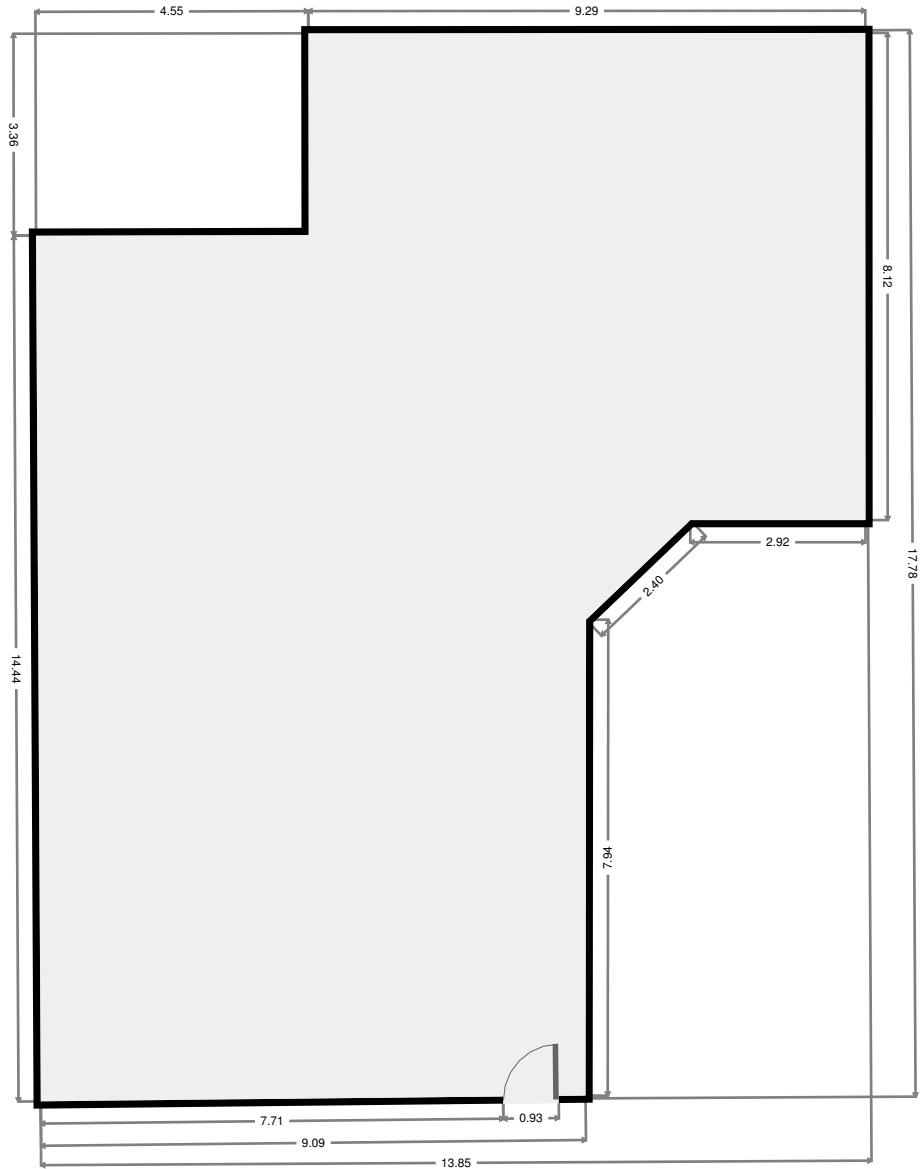
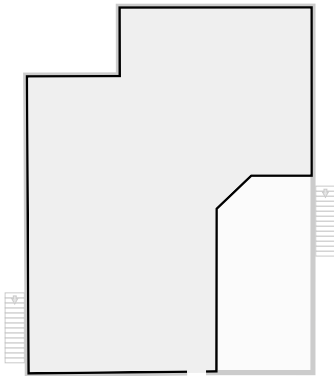

THIS FLOORPLAN IS PROVIDED WITHOUT WARRANTY OF ANY KIND. SENSOPIA DISCLAIMS ANY WARRANTY INCLUDING, WITHOUT LIMITATION, SATISFACTORY QUALITY OR ACCURACY OF DIMENSIONS.



## 10 Haven Close

2017-04-13

# Garden Area

Width: 4.54 m  
Length: 9.47 m  
Area: 41.71 m<sup>2</sup>  
Perimeter: 27.08 m  
Ceiling Height: 2.17 m

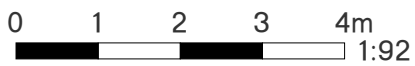
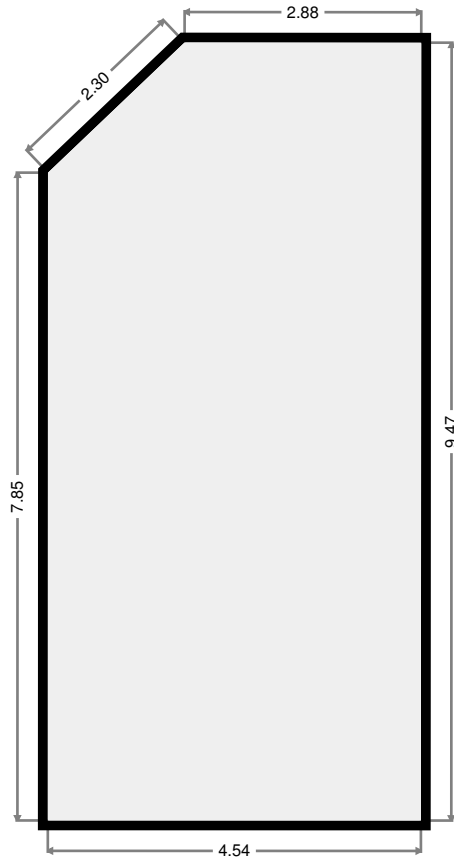
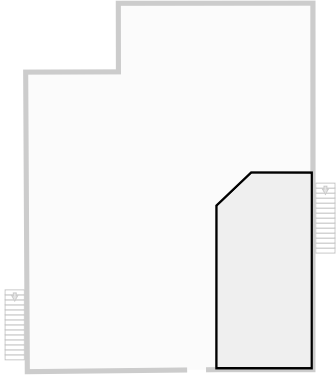

THIS FLOORPLAN IS PROVIDED WITHOUT WARRANTY OF ANY KIND. SENSOPIA DISCLAIMS ANY WARRANTY INCLUDING, WITHOUT LIMITATION, SATISFACTORY QUALITY OR ACCURACY OF DIMENSIONS.