

10 Felhaber Street

Ground Floor

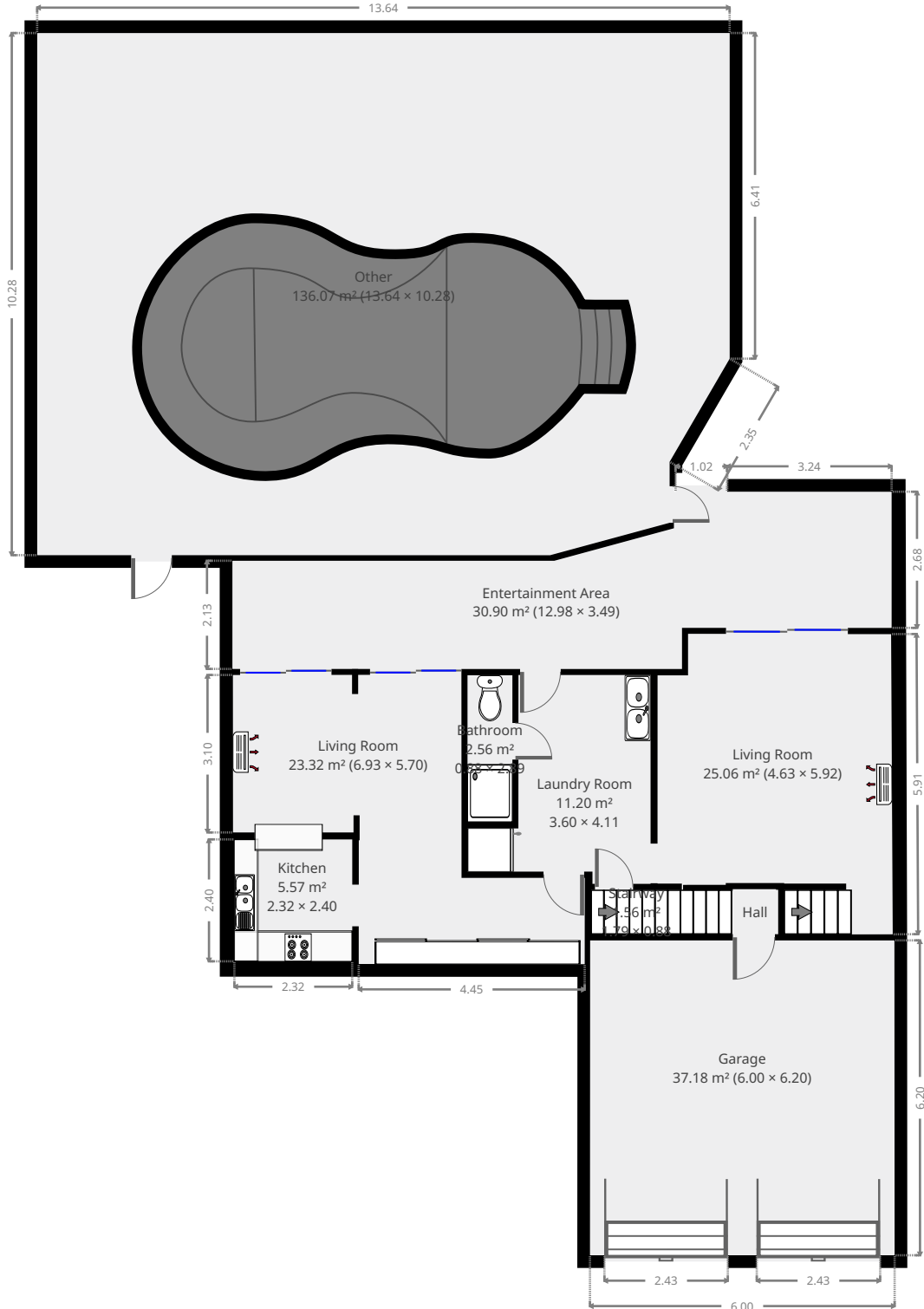

THIS FLOORPLAN IS PROVIDED WITHOUT WARRANTY OF ANY KIND. SENSOPIA DISCLAIMS ANY WARRANTY INCLUDING, WITHOUT LIMITATION, SATISFACTORY QUALITY OR ACCURACY OF DIMENSIONS.



10 Felhaber Street

Garage

Width: 6.00 m
 Length: 6.20 m
 Area: 37.18 m²
 Perimeter: 24.39 m

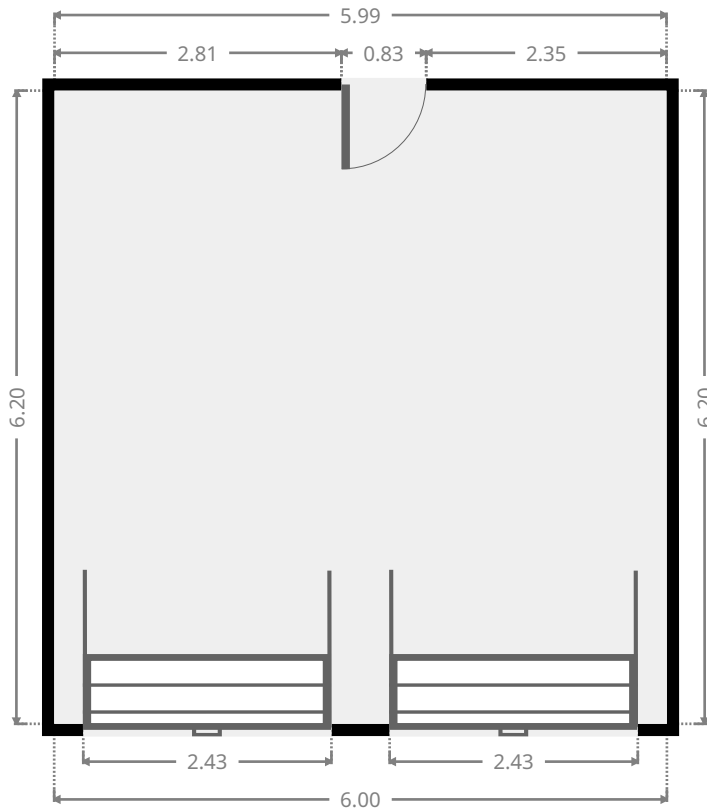
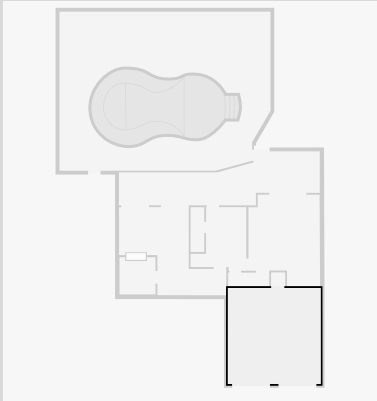

Living Room

Width: 4.63 m
 Length: 5.92 m
 Area: 25.06 m²
 Perimeter: 23.09 m

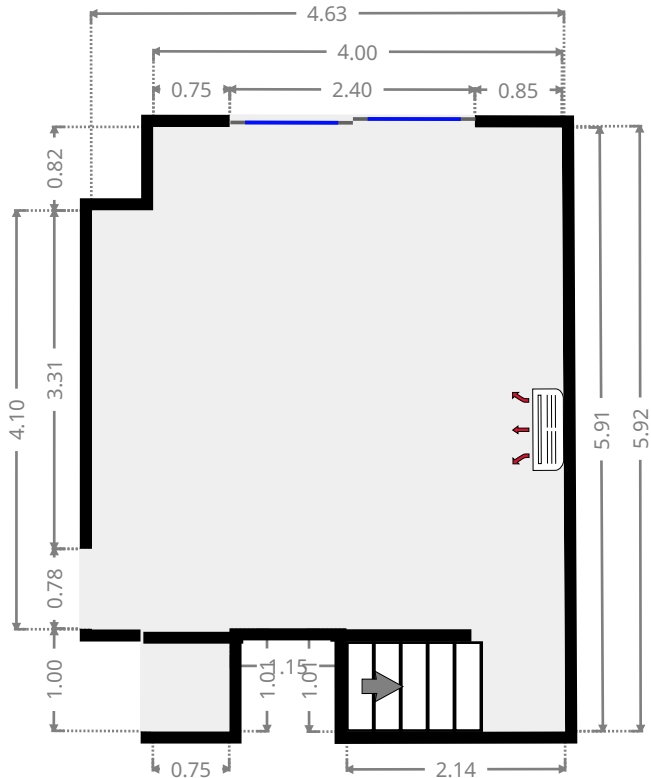
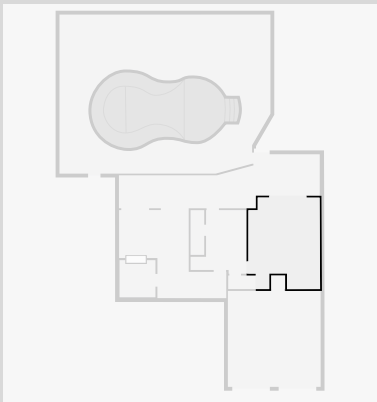

THIS FLOORPLAN IS PROVIDED WITHOUT WARRANTY OF ANY KIND. SENSOPIA DISCLAIMS ANY WARRANTY INCLUDING, WITHOUT LIMITATION, SATISFACTORY QUALITY OR ACCURACY OF DIMENSIONS.

10 Felhaber Street

Hall

Width: 0.89 m
Length: 0.91 m
Area: 0.81 m²
Perimeter: 3.59 m

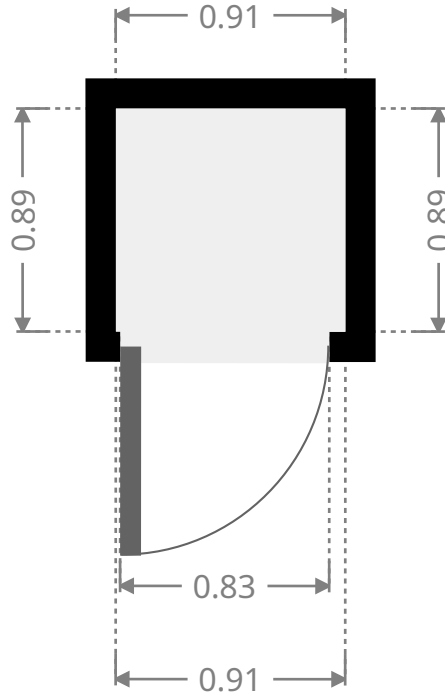
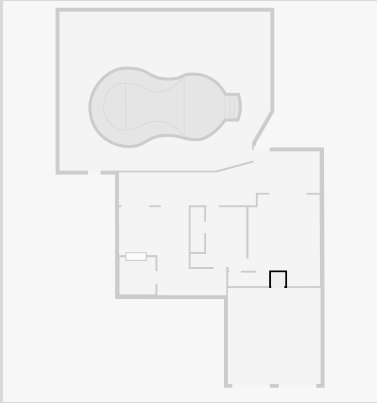

Stairway

Width: 0.88 m
Length: 1.79 m
Area: 1.56 m²
Perimeter: 5.32 m

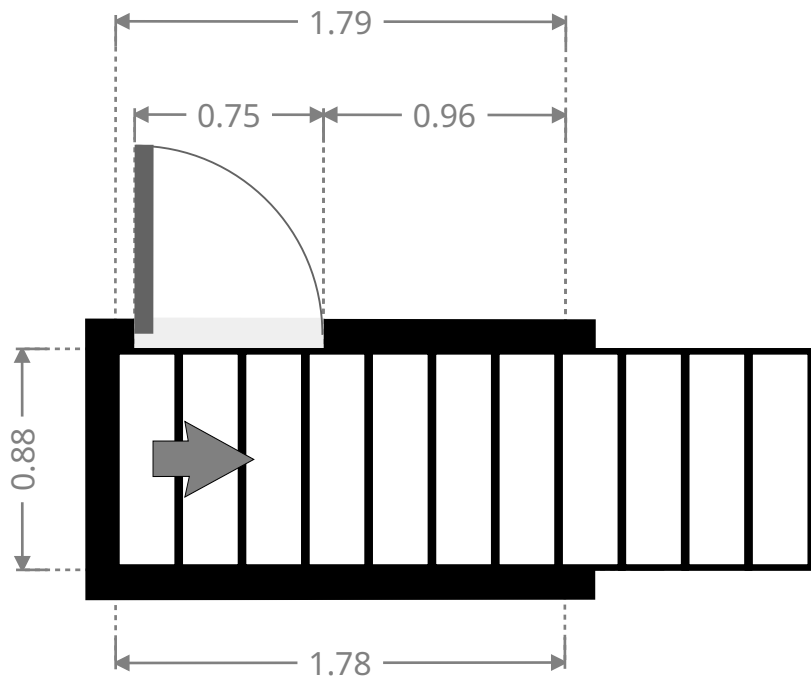
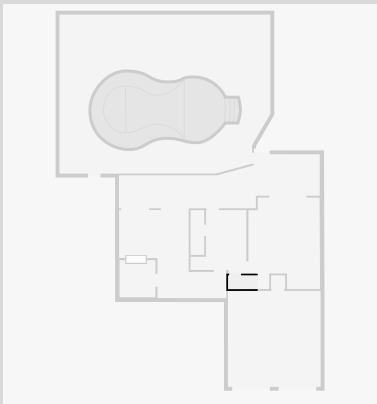

10 Felhaber Street

Laundry Room

Width: 3.60 m
 Length: 4.11 m
 Area: 11.20 m²
 Perimeter: 15.43 m

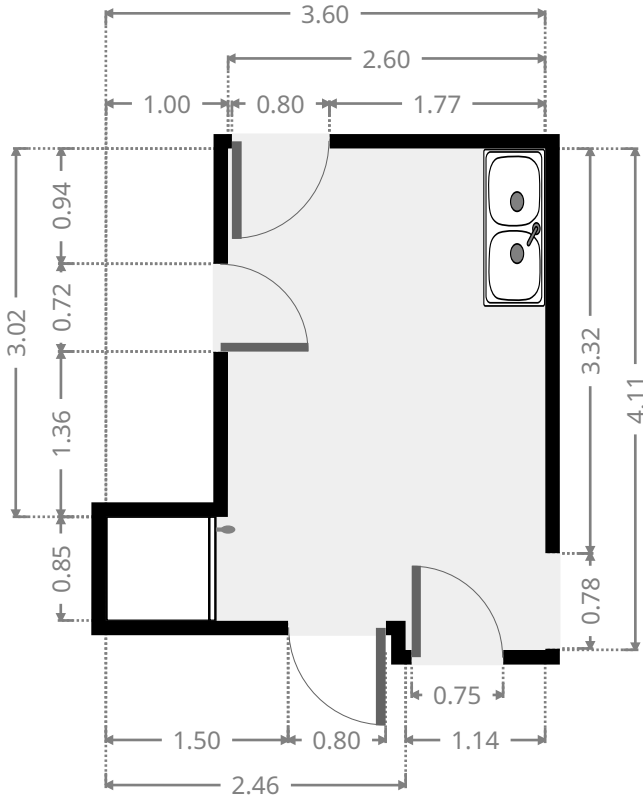
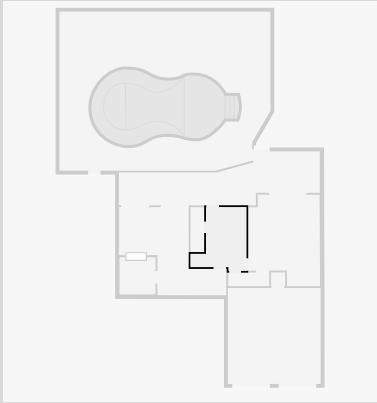

Bathroom

Width: 0.88 m
 Length: 2.89 m
 Area: 2.56 m²
 Perimeter: 7.55 m

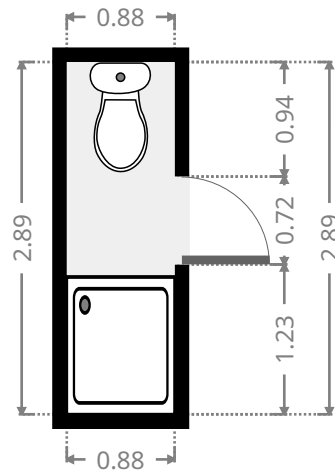
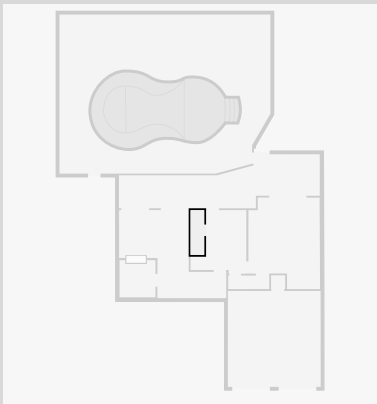

THIS FLOORPLAN IS PROVIDED WITHOUT WARRANTY OF ANY KIND. SENSOPIA DISCLAIMS ANY WARRANTY INCLUDING, WITHOUT LIMITATION, SATISFACTORY QUALITY OR ACCURACY OF DIMENSIONS.

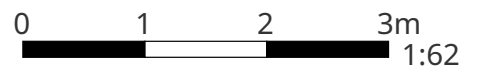

10 Felhaber Street

Living Room

Width: 5.70 m
 Length: 6.93 m
 Area: 23.32 m²
 Perimeter: 25.24 m

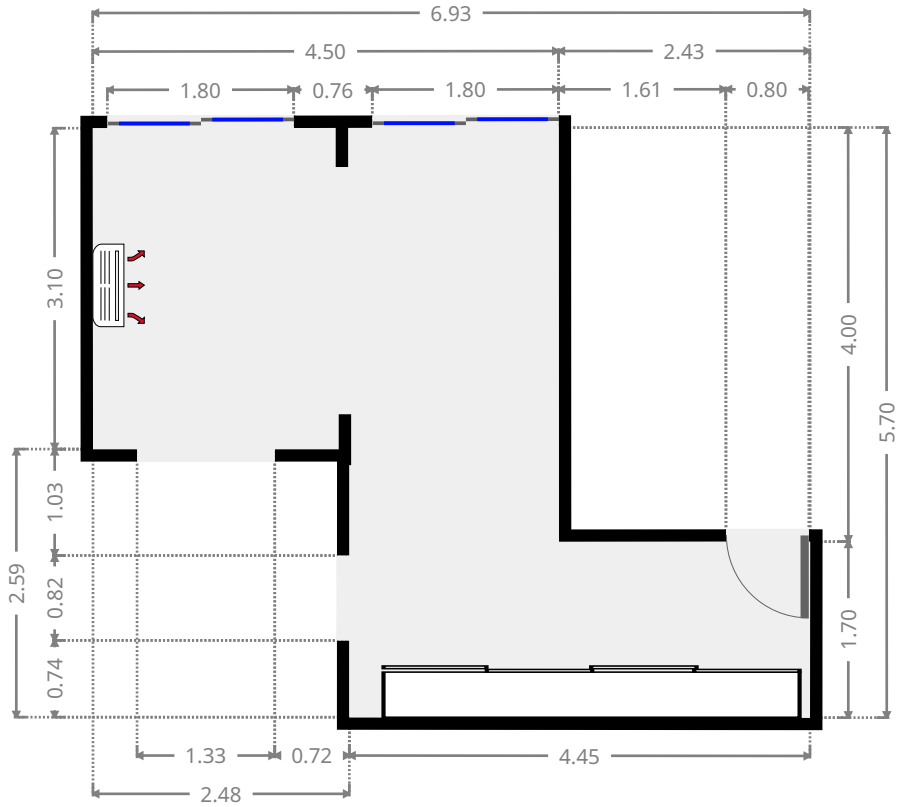
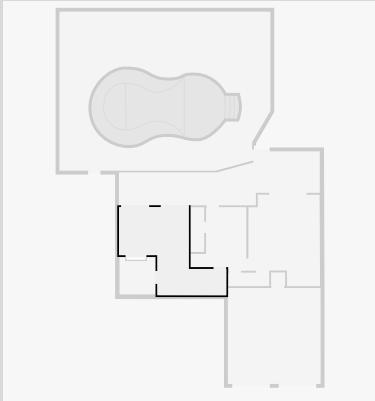

Kitchen

Width: 2.32 m
 Length: 2.40 m
 Area: 5.57 m²
 Perimeter: 9.44 m

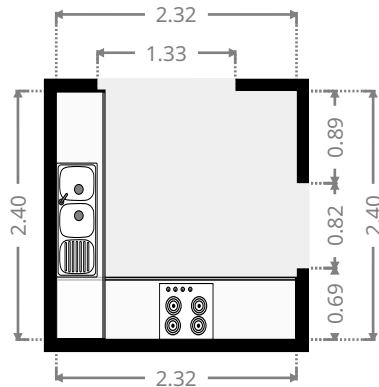
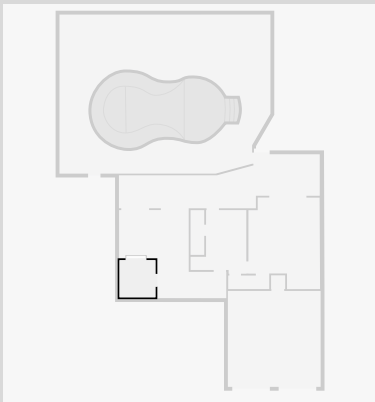

THIS FLOORPLAN IS PROVIDED WITHOUT WARRANTY OF ANY KIND. SENSOPIA DISCLAIMS ANY WARRANTY INCLUDING, WITHOUT LIMITATION, SATISFACTORY QUALITY OR ACCURACY OF DIMENSIONS.



10 Felhaber Street

Entertainment Area

Width: 3.49 m
Length: 12.98 m
Area: 30.90 m²
Perimeter: 32.39 m

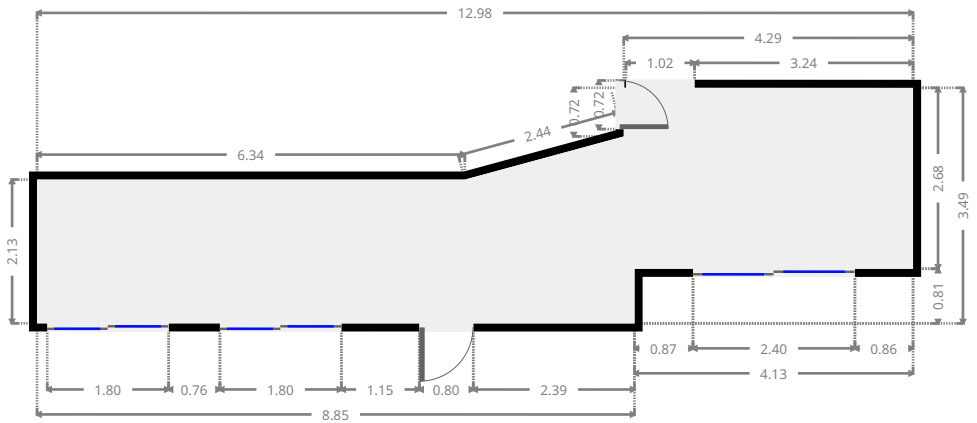
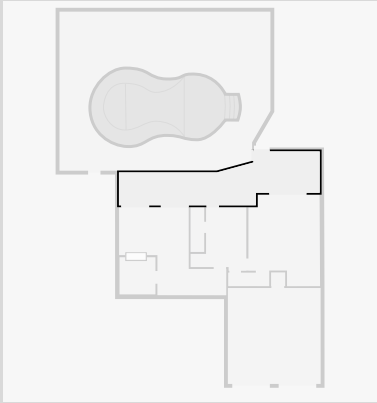

THIS FLOORPLAN IS PROVIDED WITHOUT WARRANTY OF ANY KIND. SENSOPIA DISCLAIMS ANY WARRANTY INCLUDING, WITHOUT LIMITATION, SATISFACTORY QUALITY OR ACCURACY OF DIMENSIONS.



10 Felhaber Street

Other

Width:	10.28 m
Length:	13.64 m
Area	136.07 m ²
Perimeter	46.42 m

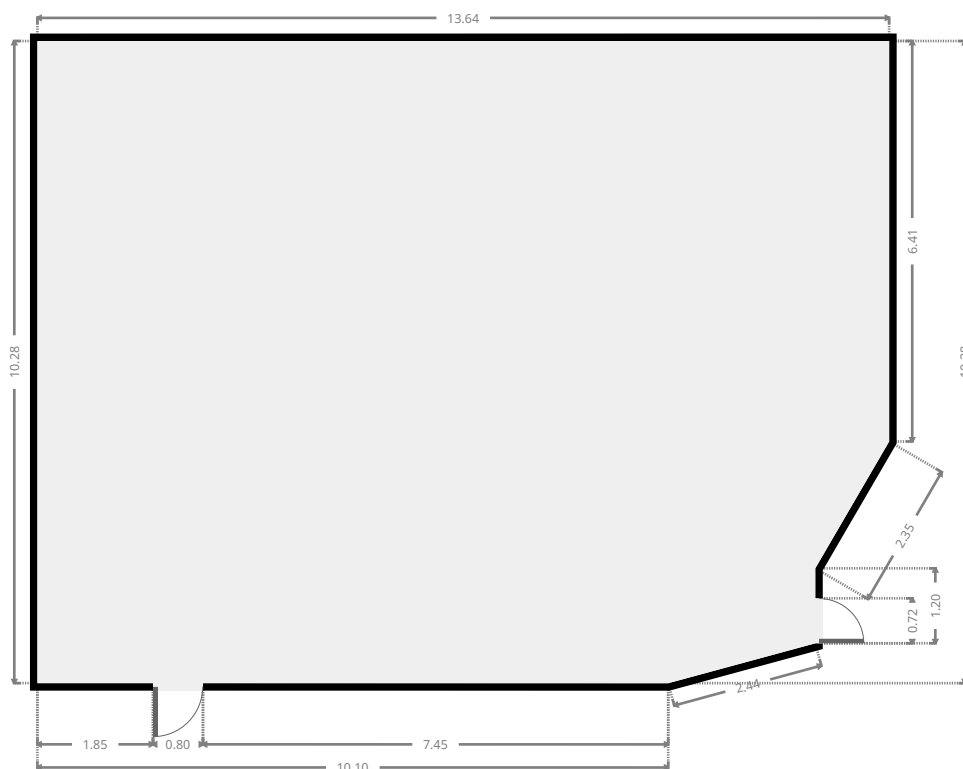
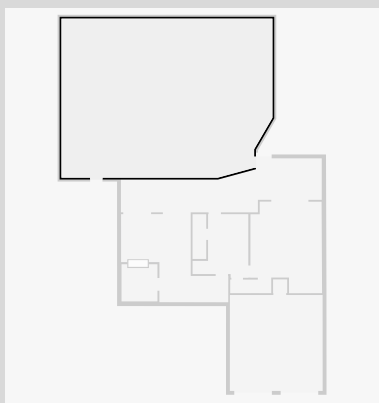

THIS FLOORPLAN IS PROVIDED WITHOUT WARRANTY OF ANY KIND. SENSOPIA DISCLAIMS ANY WARRANTY INCLUDING, WITHOUT LIMITATION, SATISFACTORY QUALITY OR ACCURACY OF DIMENSIONS.



10 Felhaber Street

1st Floor

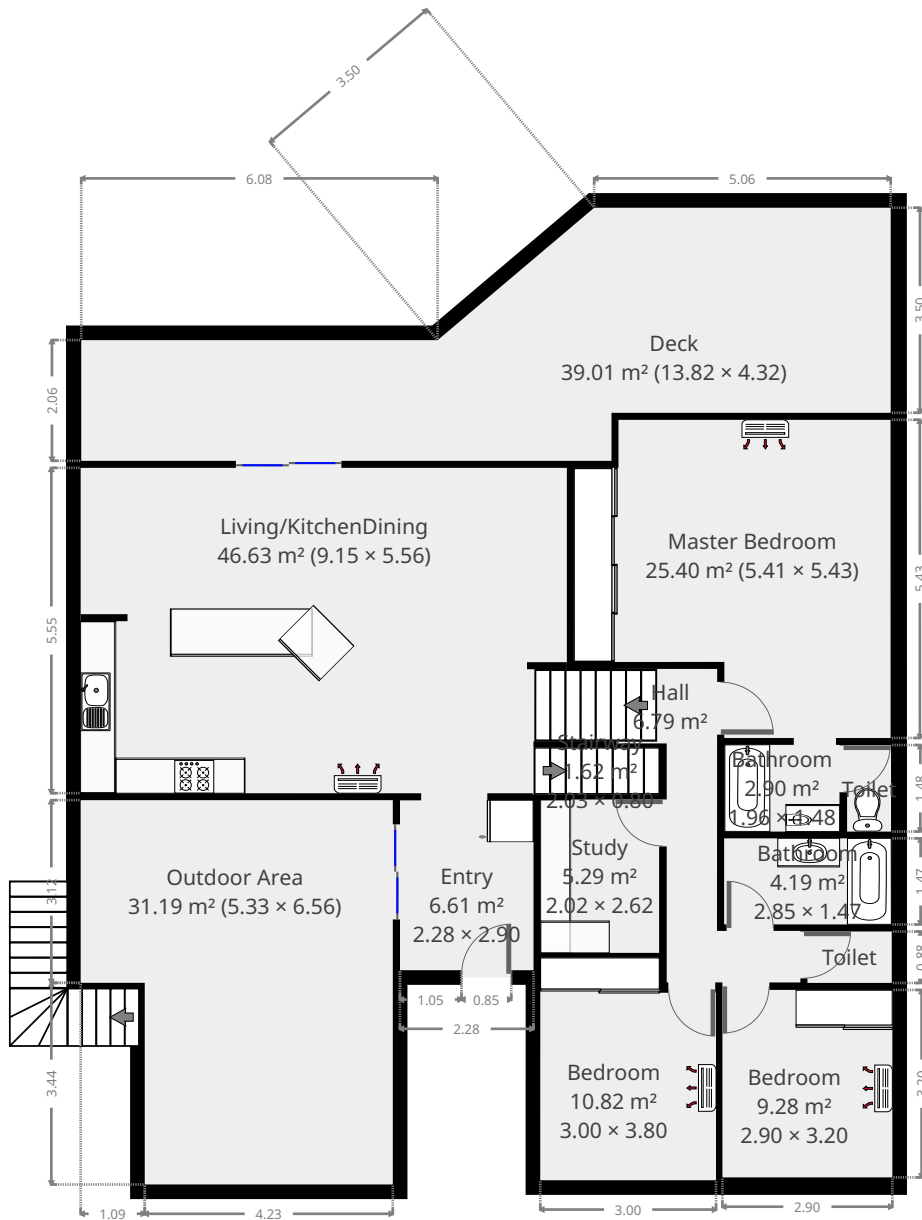

THIS FLOORPLAN IS PROVIDED WITHOUT WARRANTY OF ANY KIND. SENSOPIA DISCLAIMS ANY WARRANTY INCLUDING, WITHOUT LIMITATION, SATISFACTORY QUALITY OR ACCURACY OF DIMENSIONS.



10 Felhaber Street

Entry

Width: 2.28 m
 Length: 2.90 m
 Area: 6.61 m²
 Perimeter: 10.36 m

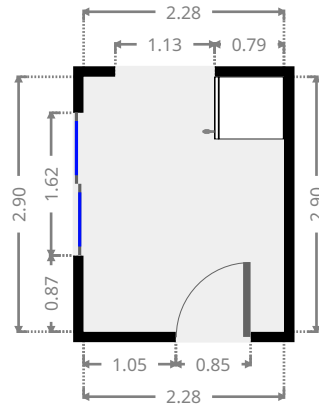
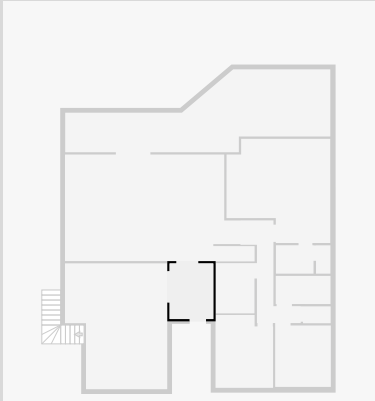

Living/KitchenDining

Width: 5.56 m
 Length: 9.15 m
 Area: 46.63 m²
 Perimeter: 29.41 m

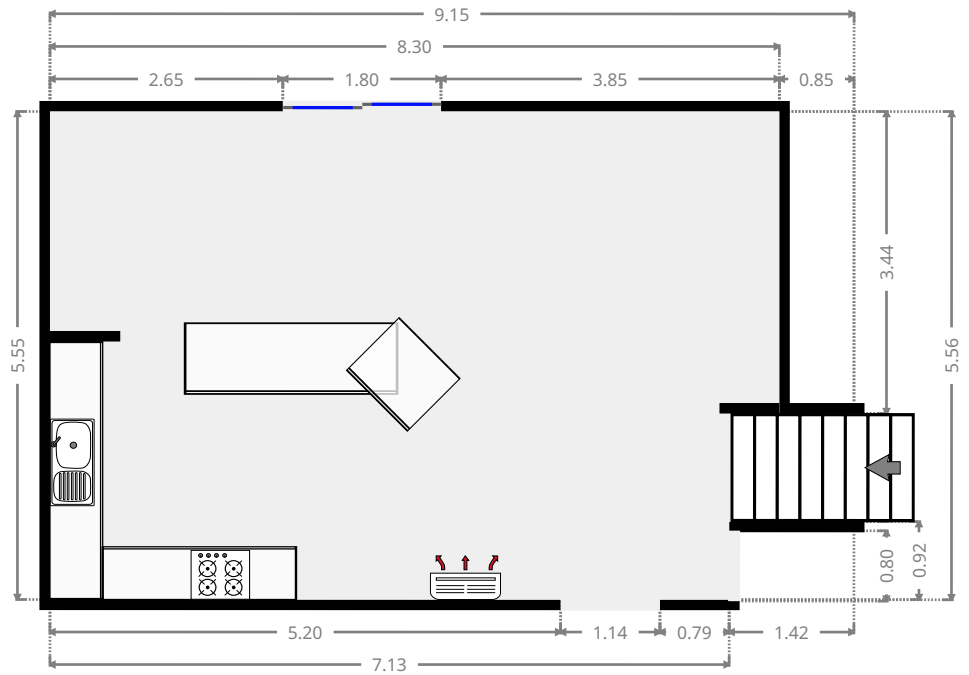
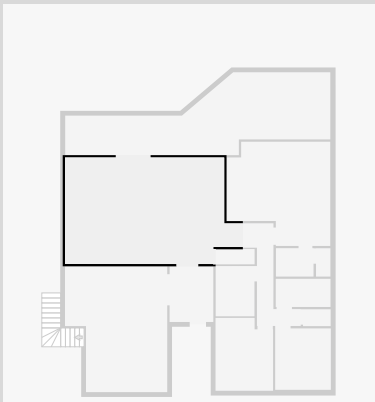

THIS FLOORPLAN IS PROVIDED WITHOUT WARRANTY OF ANY KIND. SENSOPIA DISCLAIMS ANY WARRANTY INCLUDING, WITHOUT LIMITATION, SATISFACTORY QUALITY OR ACCURACY OF DIMENSIONS.

10 Felhaber Street

Deck

Width: 4.32 m
Length: 13.82 m
Area: 39.01 m²
Perimeter: 34.84 m

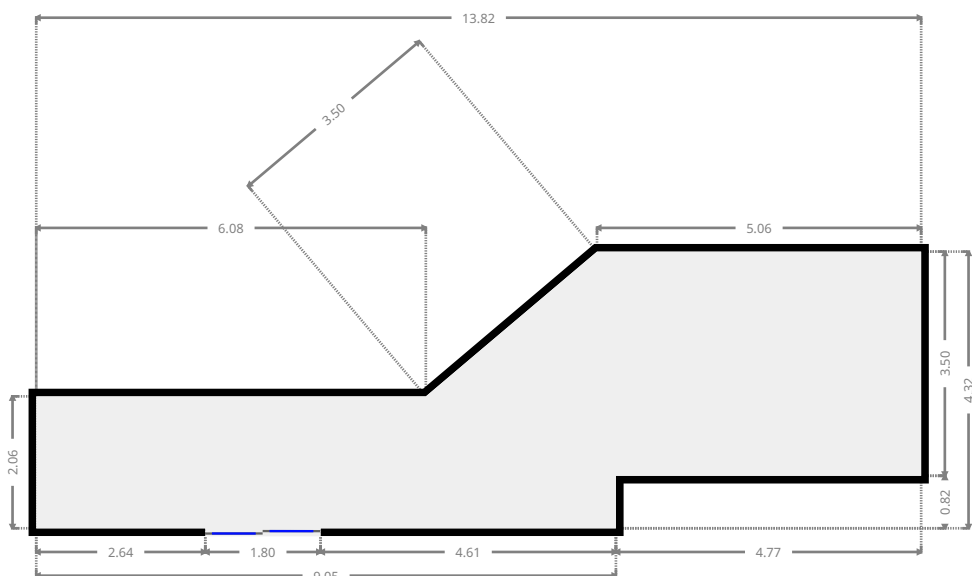
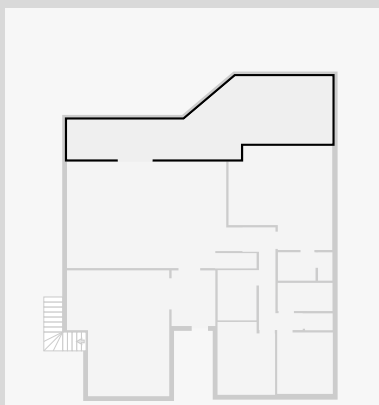

THIS FLOORPLAN IS PROVIDED WITHOUT WARRANTY OF ANY KIND. SENSOPIA DISCLAIMS ANY WARRANTY INCLUDING, WITHOUT LIMITATION, SATISFACTORY QUALITY OR ACCURACY OF DIMENSIONS.



10 Felhaber Street

Hall

Width: 3.02 m
 Length: 5.35 m
 Area: 6.79 m²
 Perimeter: 16.75 m

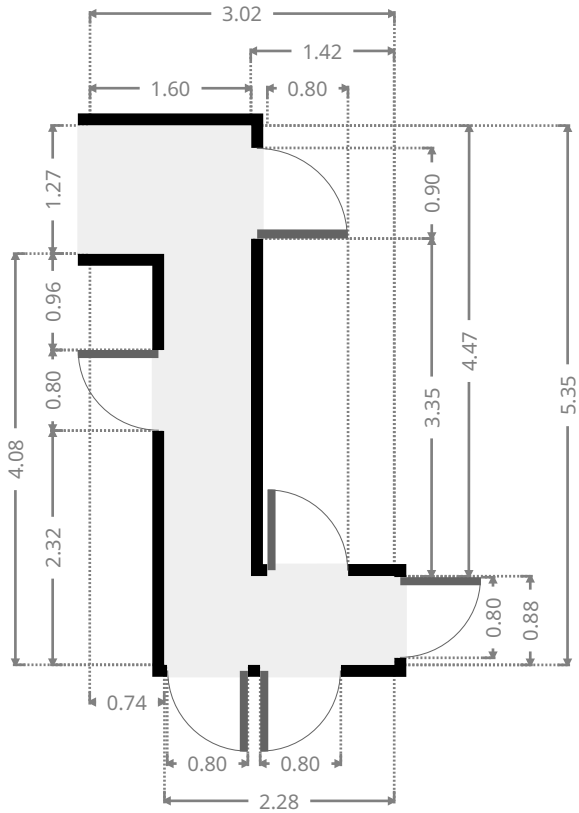
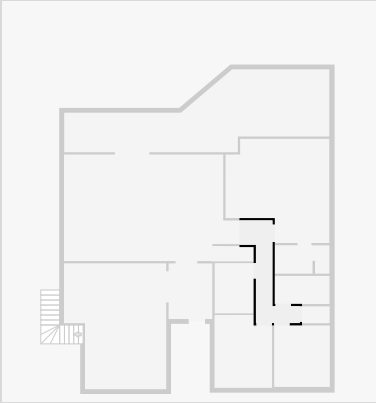

Study

Width: 2.02 m
 Length: 2.62 m
 Area: 5.29 m²
 Perimeter: 9.28 m

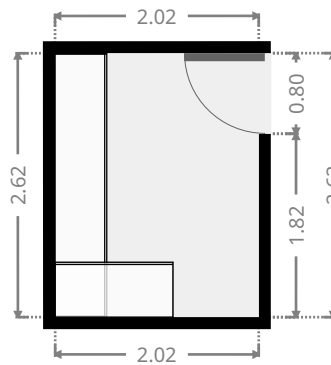
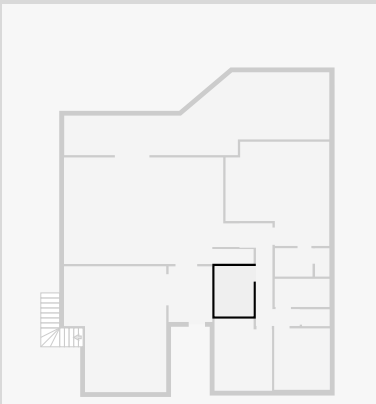

10 Felhaber Street

Bedroom

Width: 3.00 m
 Length: 3.80 m
 Area: 10.82 m²
 Perimeter: 13.60 m

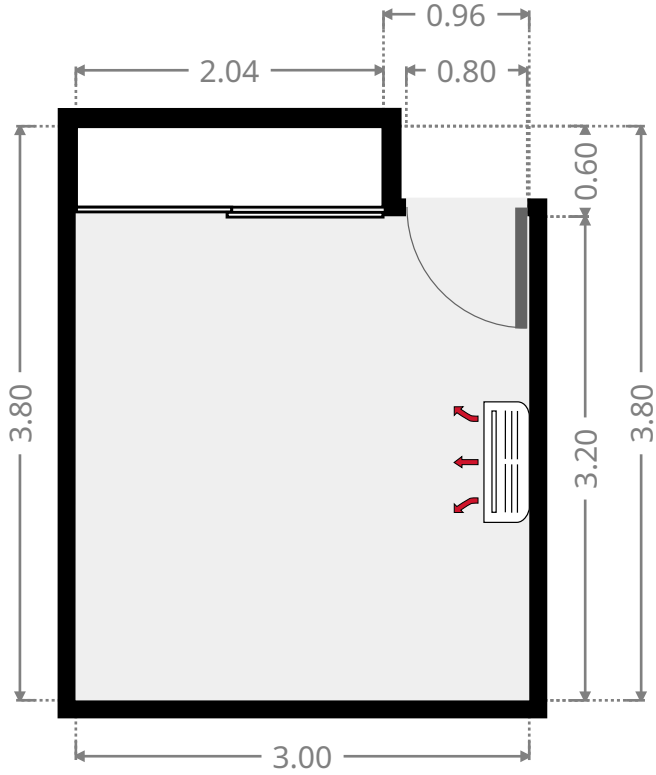
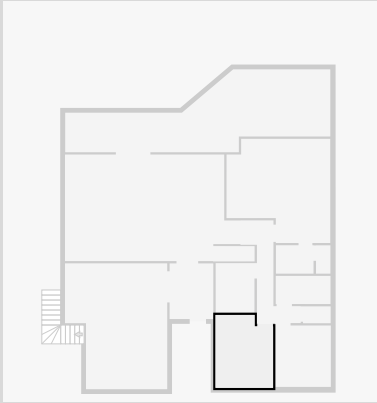

Stairway

Width: 0.80 m
 Length: 2.03 m
 Area: 1.62 m²
 Perimeter: 5.66 m

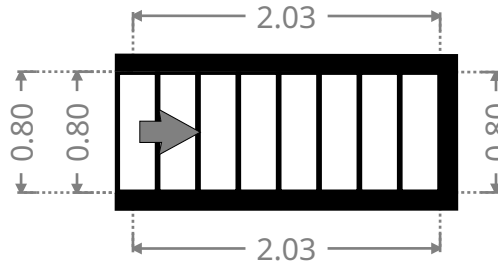
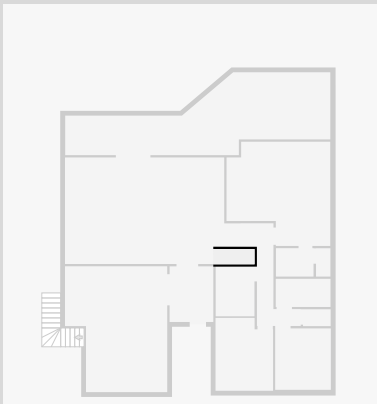

10 Felhaber Street

Bedroom

Width: 2.90 m
Length: 3.20 m
Area: 9.28 m²
Perimeter: 12.20 m

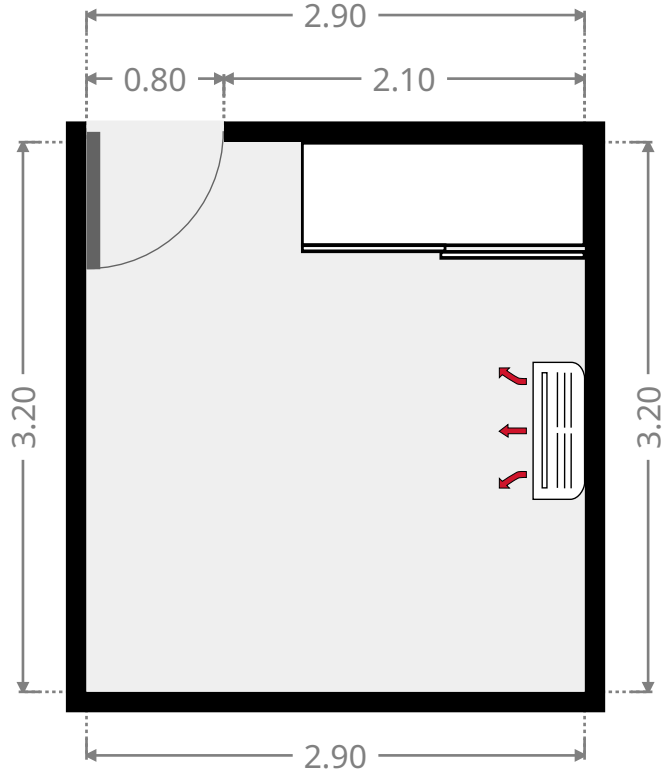
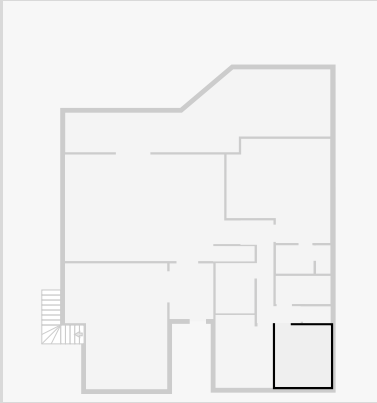

Toilet / Half Bath

Width: 0.88 m
Length: 1.44 m
Area: 1.26 m²
Perimeter: 4.63 m

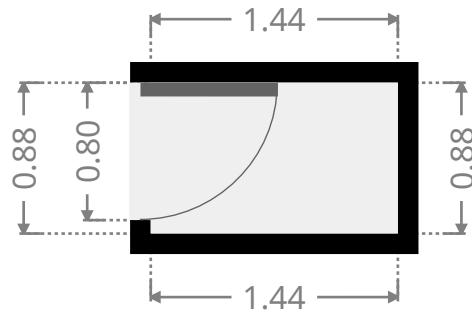
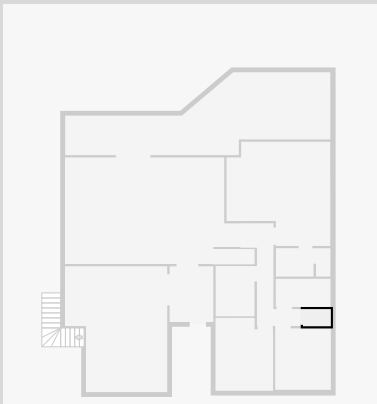

10 Felhaber Street

Bathroom

Width: 1.47 m
 Length: 2.85 m
 Area: 4.19 m²
 Perimeter: 8.65 m

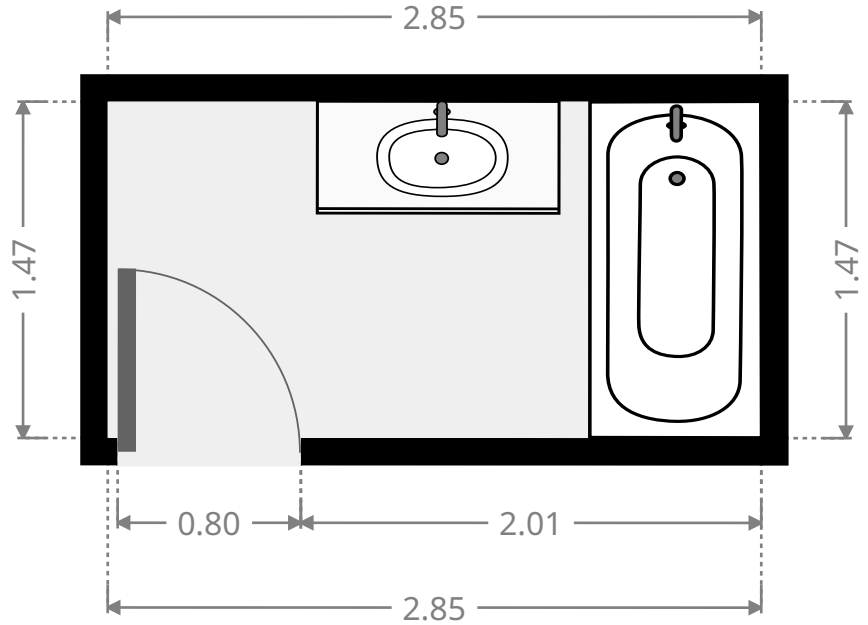
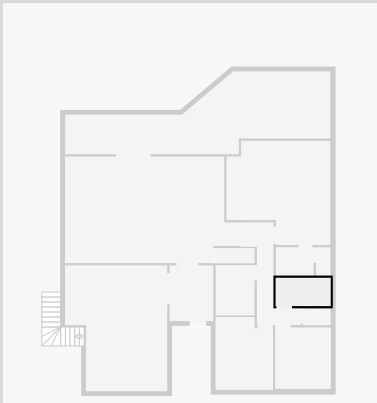

Bathroom

Width: 1.48 m
 Length: 1.96 m
 Area: 2.90 m²
 Perimeter: 6.88 m

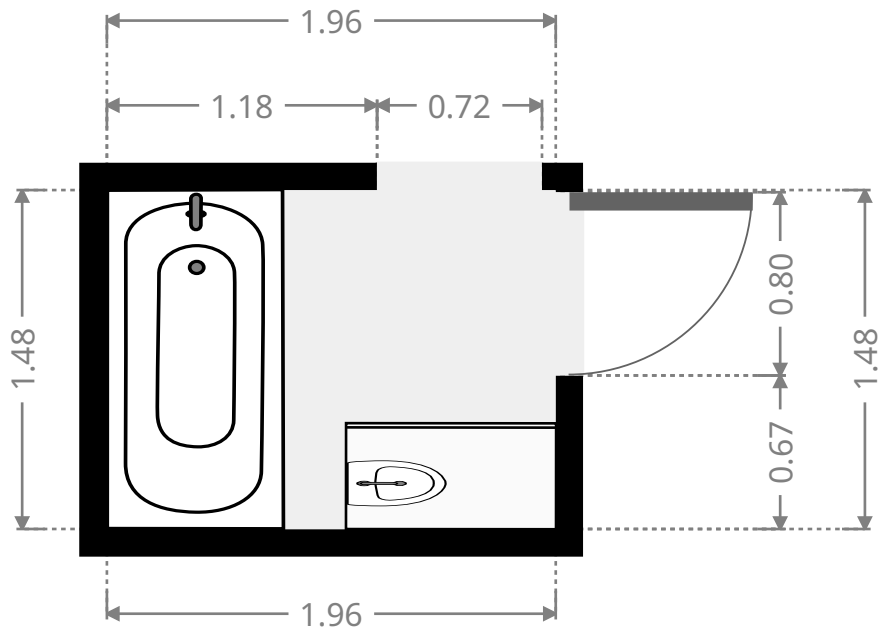
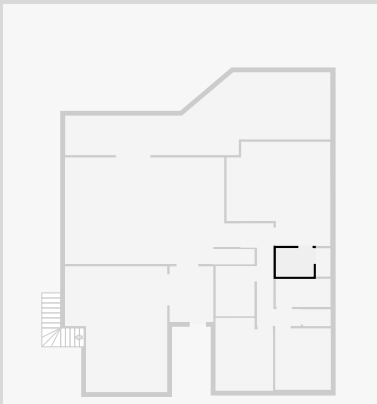

THIS FLOORPLAN IS PROVIDED WITHOUT WARRANTY OF ANY KIND. SENSOPIA DISCLAIMS ANY WARRANTY INCLUDING, WITHOUT LIMITATION, SATISFACTORY QUALITY OR ACCURACY OF DIMENSIONS.

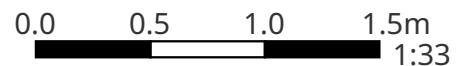

10 Felhaber Street

Toilet / Half Bath

Width: 0.75 m
 Length: 1.48 m
 Area: 1.11 m²
 Perimeter: 4.45 m

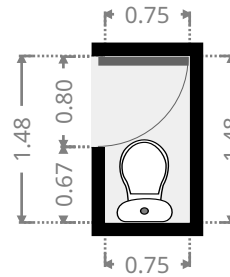
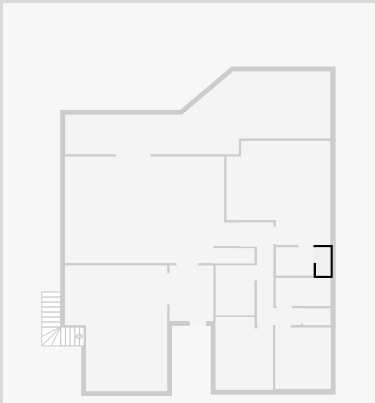

Master Bedroom

Width: 5.41 m
 Length: 5.43 m
 Area: 25.40 m²
 Perimeter: 21.68 m

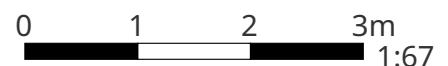
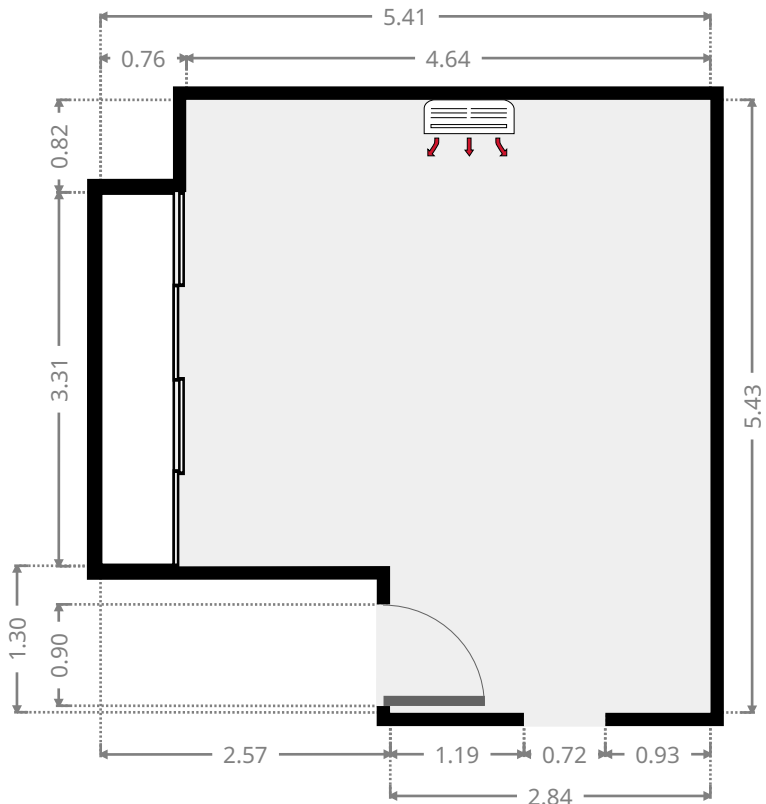
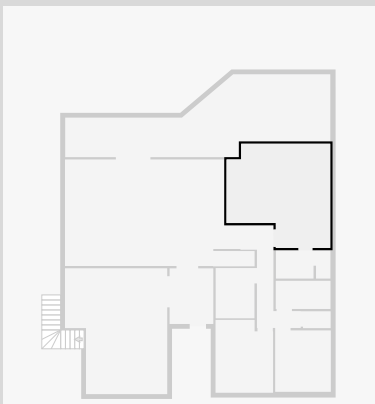

THIS FLOORPLAN IS PROVIDED WITHOUT WARRANTY OF ANY KIND. SENSOPIA DISCLAIMS ANY WARRANTY INCLUDING, WITHOUT LIMITATION, SATISFACTORY QUALITY OR ACCURACY OF DIMENSIONS.

10 Felhaber Street

Outdoor Area

Width: 5.33 m
Length: 6.56 m
Area: 31.19 m²
Perimeter: 23.78 m

