

10 Dream Drive

SUBMITTED BY

Ray White Rockhampton Casey
stockers@cqoz.com

CREATED ON

2022-12-12

Floors

1

▼ Ground Floor



▼ **Bathroom**
Ground Floor

WIDTH: 1.93 m • LENGTH: 2.52 m
AREA: 4.86 m² • PERIMETER: 8.90 m

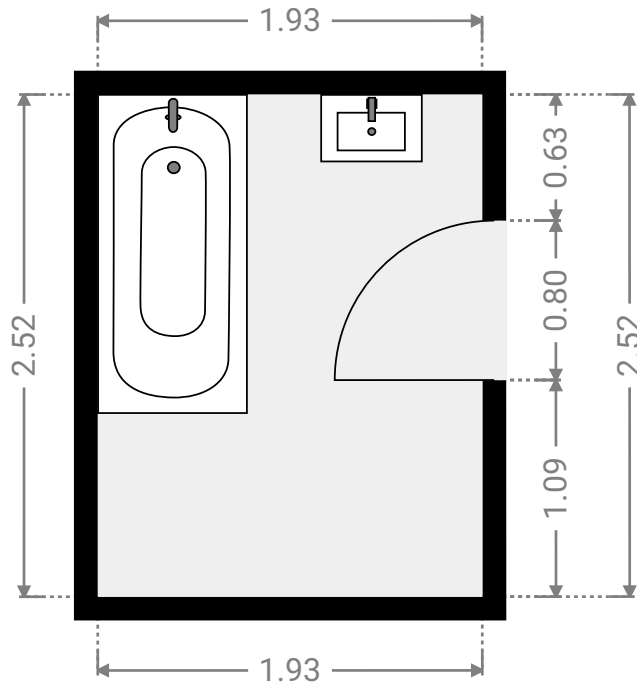
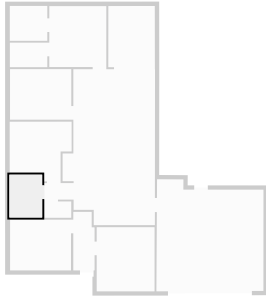

▼ **Bathroom**
Ground Floor

WIDTH: 2.20 m • LENGTH: 2.05 m
AREA: 4.52 m² • PERIMETER: 8.51 m

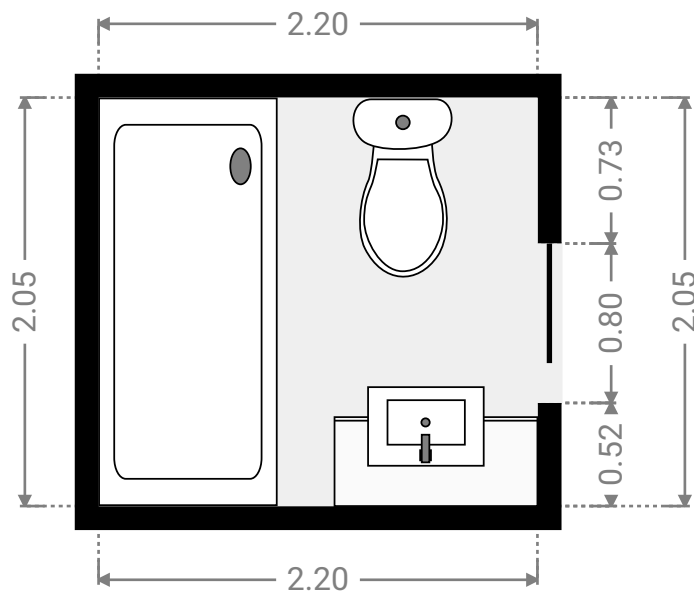
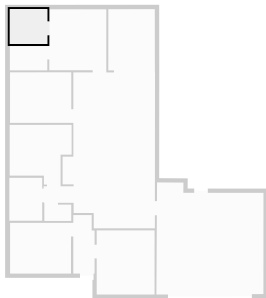

▼ **Bedroom**
Ground Floor

WIDTH: 3.58 m • LENGTH: 2.98 m
AREA: 10.67 m² • PERIMETER: 13.12 m

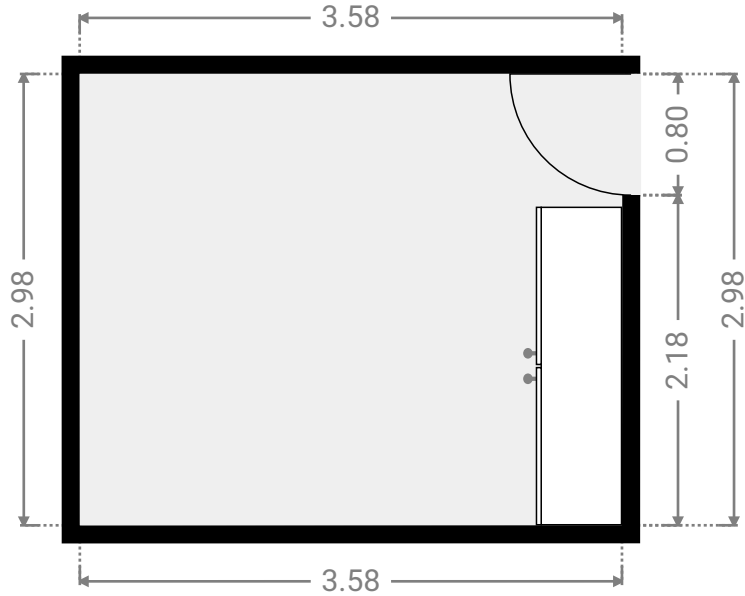
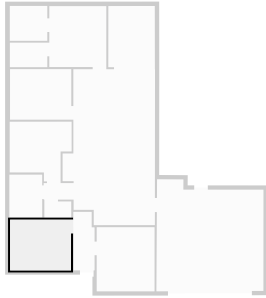

▼ **Bedroom**
Ground Floor

WIDTH: 3.64 m • LENGTH: 3.51 m
AREA: 10.57 m² • PERIMETER: 14.30 m

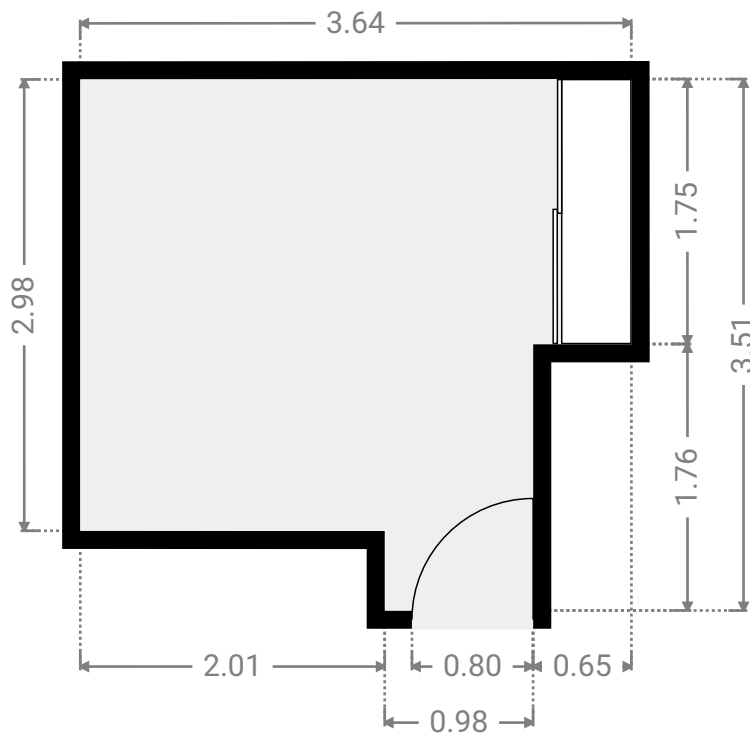
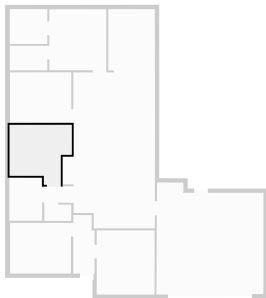

▼ Bedroom
Ground Floor

WIDTH: 3.60 m • LENGTH: 2.97 m
AREA: 10.69 m² • PERIMETER: 13.14 m

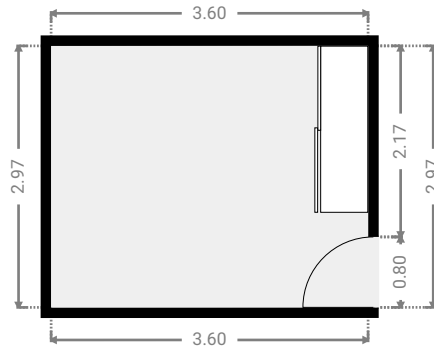
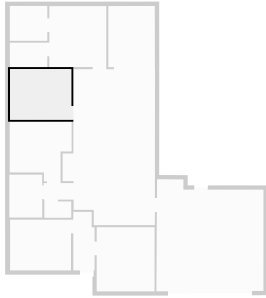

▼ Garage
Ground Floor

WIDTH: 6.31 m • LENGTH: 6.59 m
AREA: 38.36 m² • PERIMETER: 25.69 m

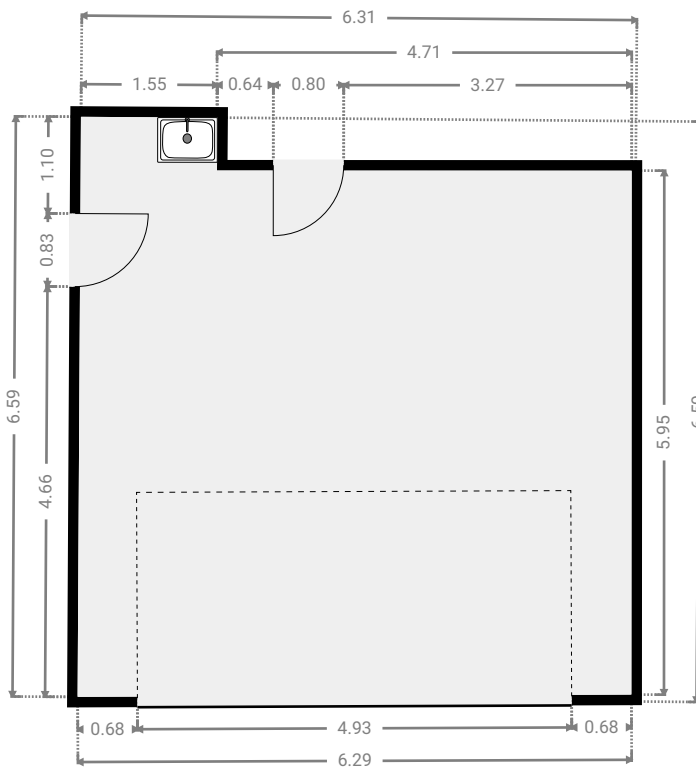
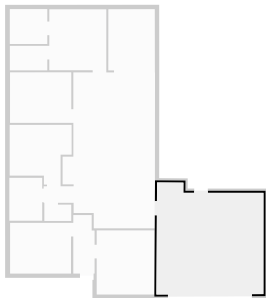

▼ **Hall**
Ground Floor

WIDTH: 1.25 m • LENGTH: 3.44 m
AREA: 4.14 m² • PERIMETER: 9.38 m

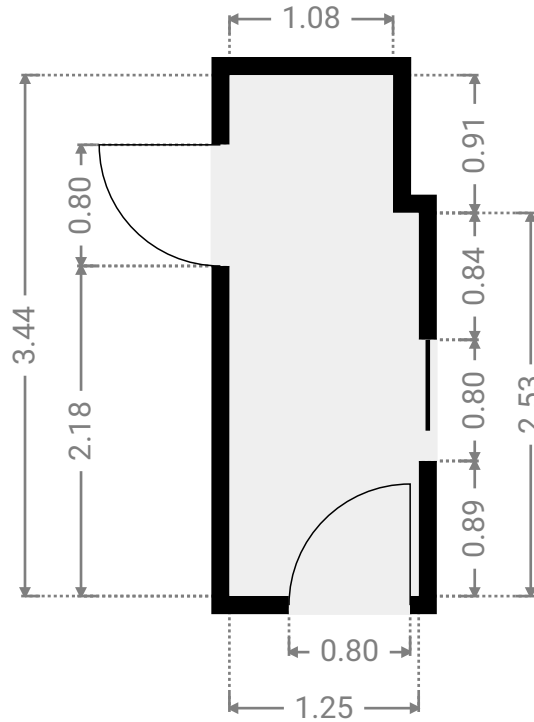
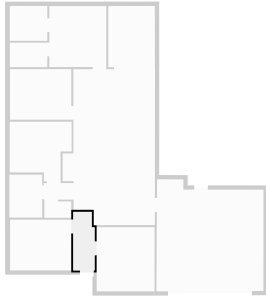

▼ **Hall**
Ground Floor

WIDTH: 1.66 m • LENGTH: 0.97 m
AREA: 1.61 m² • PERIMETER: 5.26 m

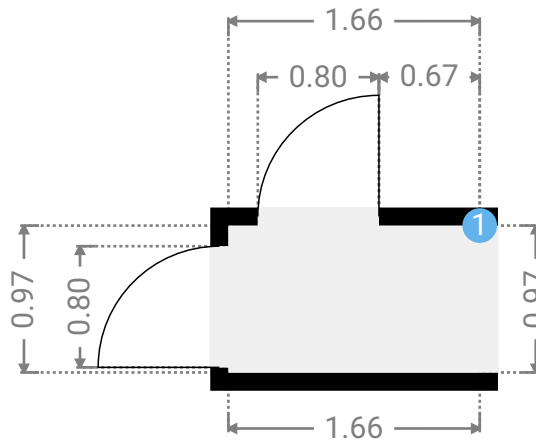
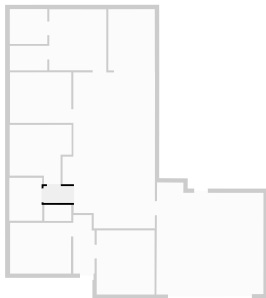

▼ Hall/Ground Floor

1 OPENING

Height
0.00 m



▼ Kitchen Ground Floor

WIDTH: 5.43 m • LENGTH: 9.17 m
AREA: 43.87 m² • PERIMETER: 29.18 m

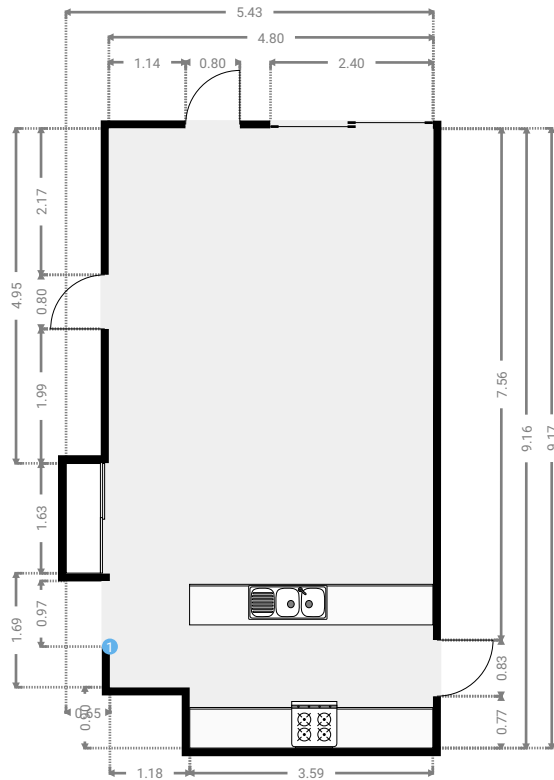
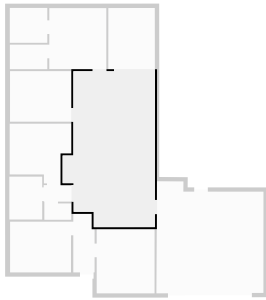

▼ Living Room Ground Floor

WIDTH: 3.40 m • LENGTH: 3.77 m
AREA: 12.82 m² • PERIMETER: 14.34 m

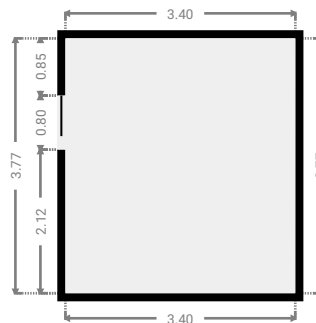
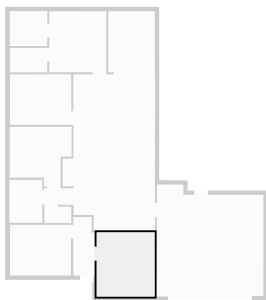

FLOORS: 1

▼ **Other**
Ground Floor

WIDTH: 2.74 m • LENGTH: 3.60 m
AREA: 9.83 m² • PERIMETER: 12.66 m

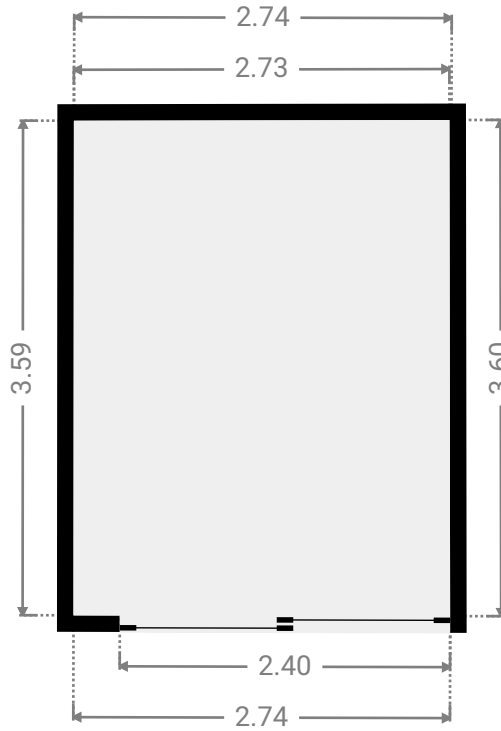
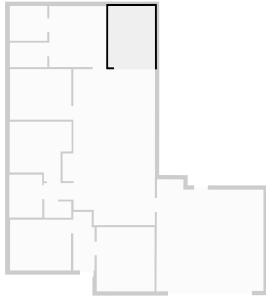

▼ **Primary Bedroom**
Ground Floor

WIDTH: 3.35 m • LENGTH: 3.58 m
AREA: 11.99 m² • PERIMETER: 13.86 m

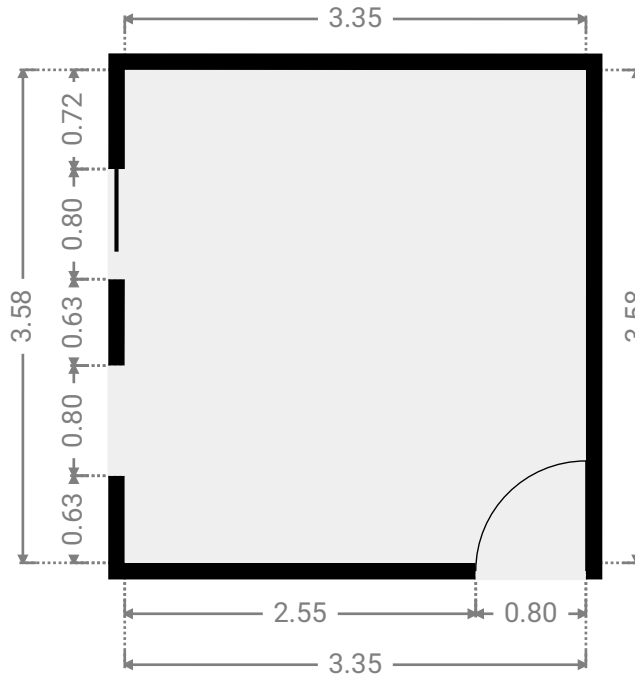
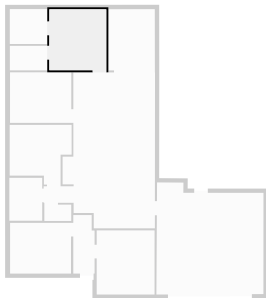

▼ **Closet**
Ground Floor

WIDTH: 2.20 m • LENGTH: 1.44 m
AREA: 3.17 m² • PERIMETER: 7.28 m

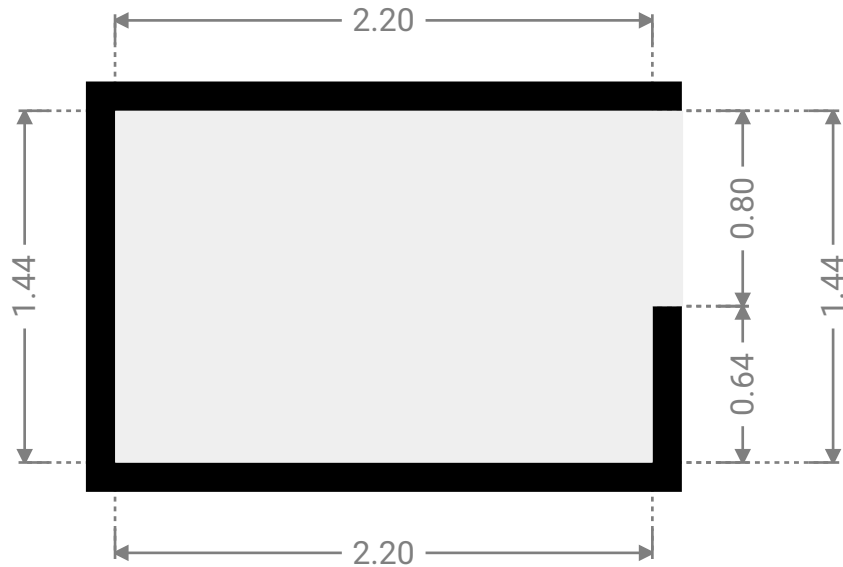
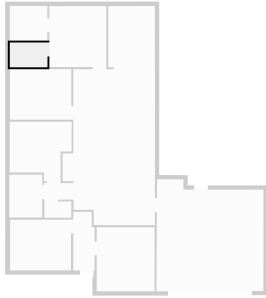

▼ **Toilet**
Ground Floor

WIDTH: 1.58 m • LENGTH: 0.96 m
AREA: 1.52 m² • PERIMETER: 5.08 m

