

10 Candlebark Court

Created on
2021-06-03

Floors
1

▼ Ground Floor



▼ **Bedroom**
Ground Floor

WIDTH: 3.10 m • LENGTH: 3.65 m
AREA: 11.31 m² • PERIMETER: 13.50 m

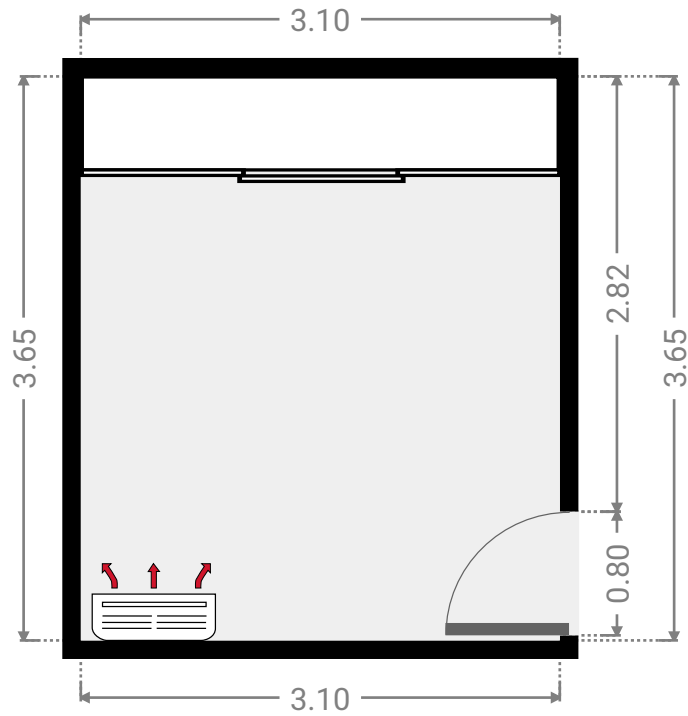

▼ **Other**
Ground Floor

WIDTH: 2.79 m • LENGTH: 1.74 m
AREA: 4.85 m² • PERIMETER: 9.06 m

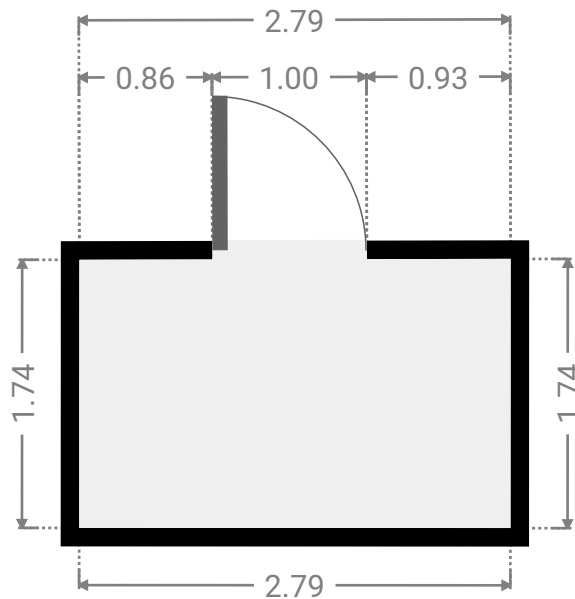

▼ Other
Ground Floor

WIDTH: 7.41 m • LENGTH: 17.62 m
AREA: 126.73 m² • PERIMETER: 50.05 m

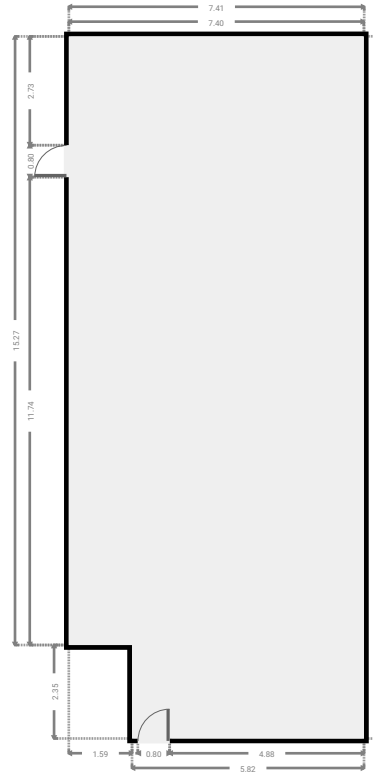
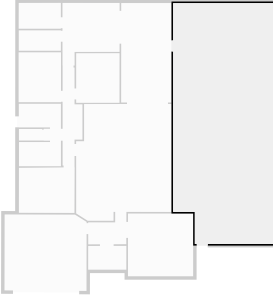

▼ Other
Ground Floor

WIDTH: 3.69 m • LENGTH: 7.28 m
AREA: 26.77 m² • PERIMETER: 21.91 m

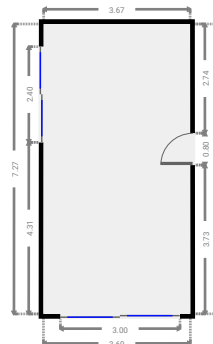
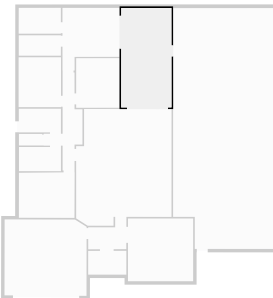

▼ **Bedroom**
Ground Floor

WIDTH: 4.08 m • LENGTH: 3.34 m
AREA: 13.49 m² • PERIMETER: 14.77 m

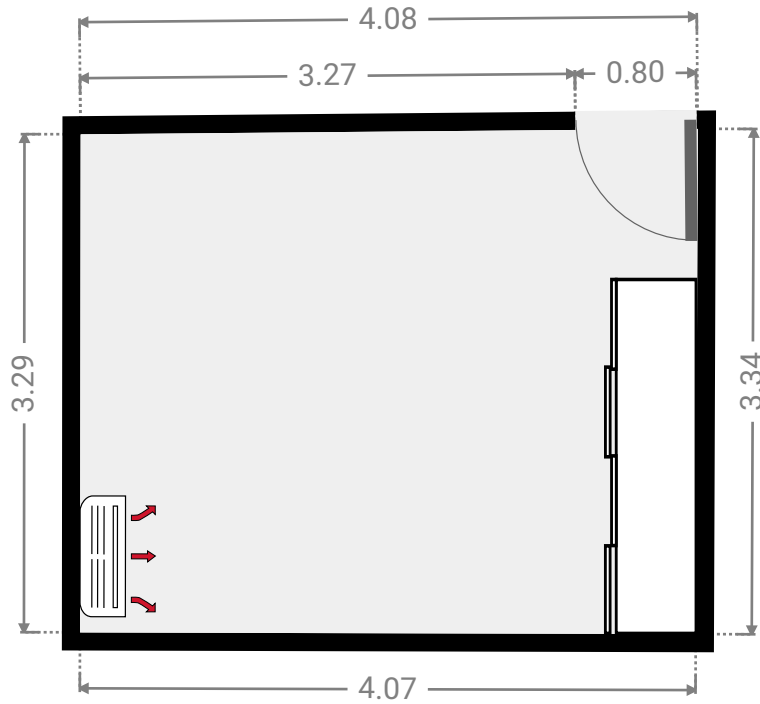
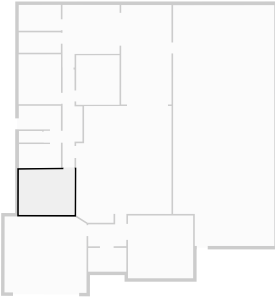

▼ **Bedroom**
Ground Floor

WIDTH: 3.17 m • LENGTH: 3.63 m
AREA: 11.51 m² • PERIMETER: 13.60 m

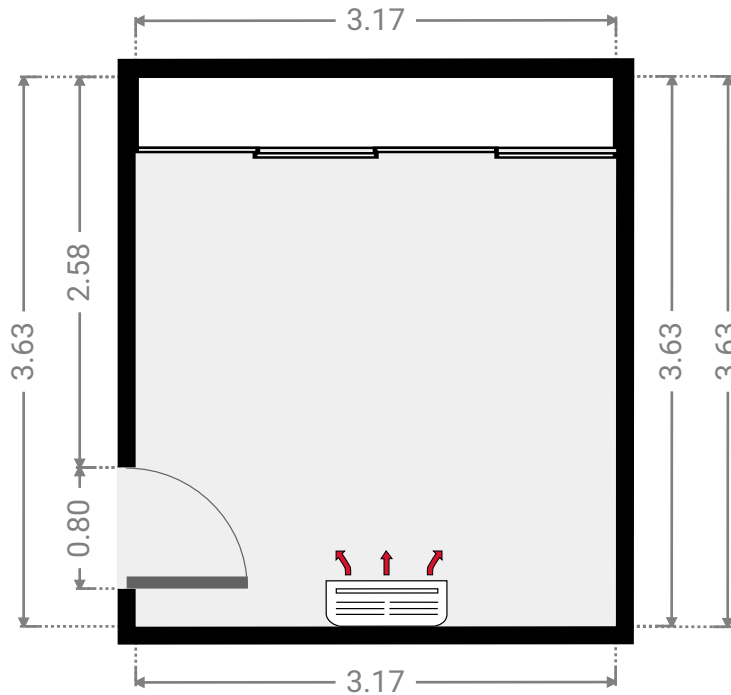
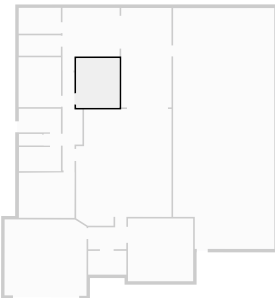

▼ Bathroom Ground Floor

WIDTH: 3.08 m • LENGTH: 1.89 m
AREA: 5.82 m² • PERIMETER: 9.94 m

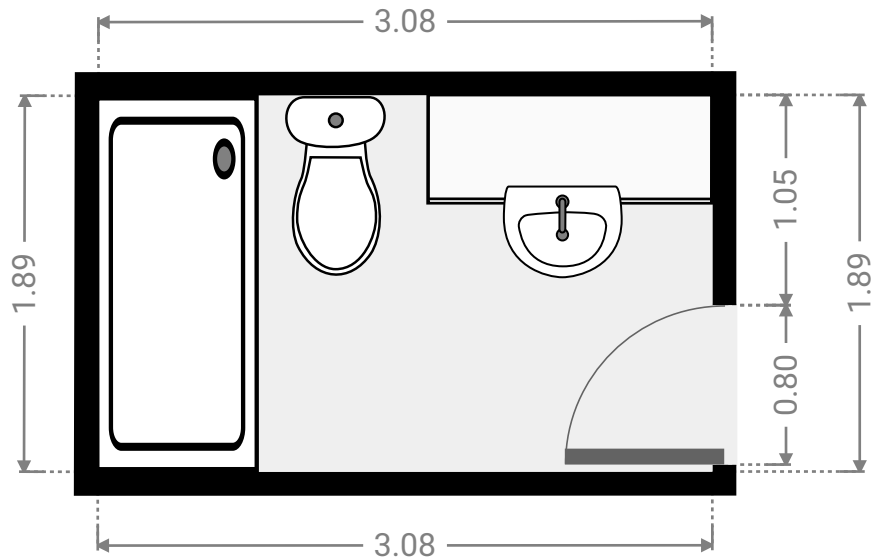

▼ Closet Ground Floor

WIDTH: 3.08 m • LENGTH: 1.49 m
AREA: 4.59 m² • PERIMETER: 9.14 m

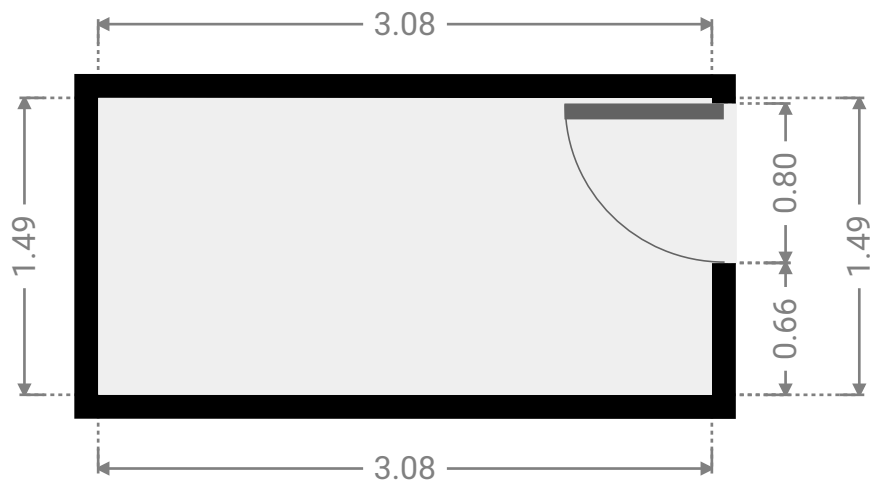

▼ Master Bedroom
Ground Floor

WIDTH: 4.18 m • LENGTH: 4.58 m
AREA: 15.84 m² • PERIMETER: 17.51 m

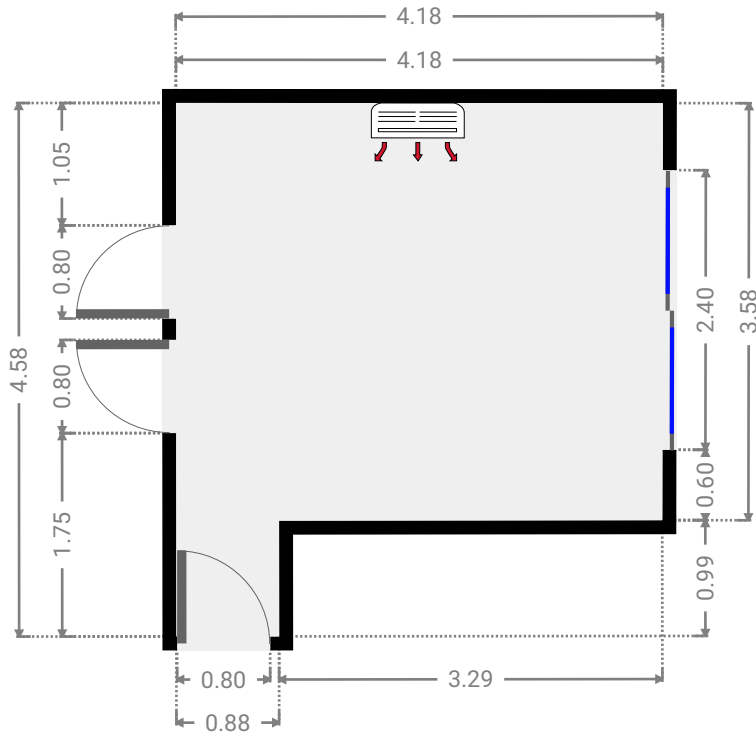

▼ Hall
Ground Floor

WIDTH: 2.80 m • LENGTH: 2.25 m
AREA: 4.99 m² • PERIMETER: 10.07 m

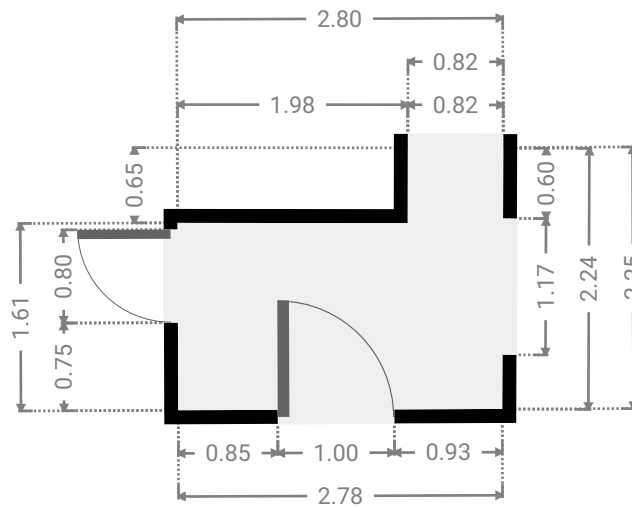

▼ Laundry Room
Ground Floor

WIDTH: 3.08 m • LENGTH: 1.73 m
AREA: 5.33 m² • PERIMETER: 9.62 m

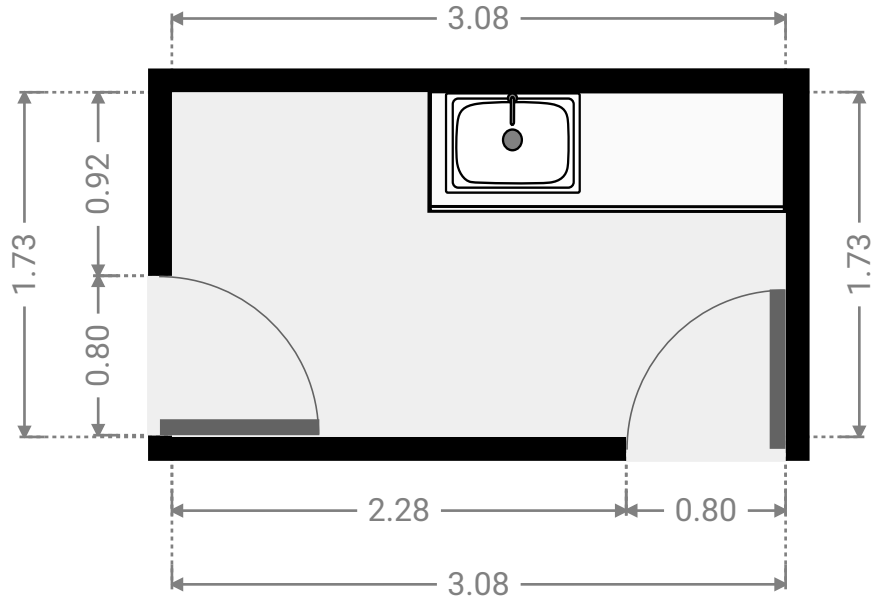

▼ Toilet
Ground Floor

WIDTH: 1.69 m • LENGTH: 0.84 m
AREA: 1.43 m² • PERIMETER: 5.08 m

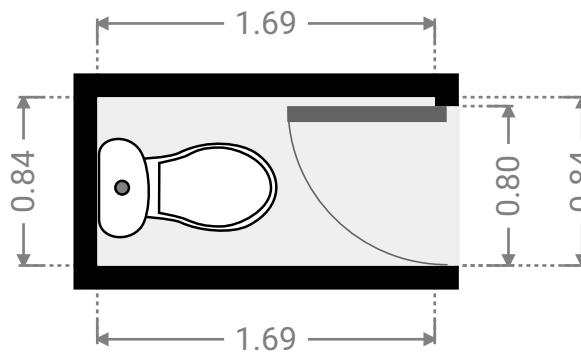

▼ Hall Ground Floor

WIDTH: 1.26 m • LENGTH: 0.87 m
AREA: 1.10 m² • PERIMETER: 4.26 m

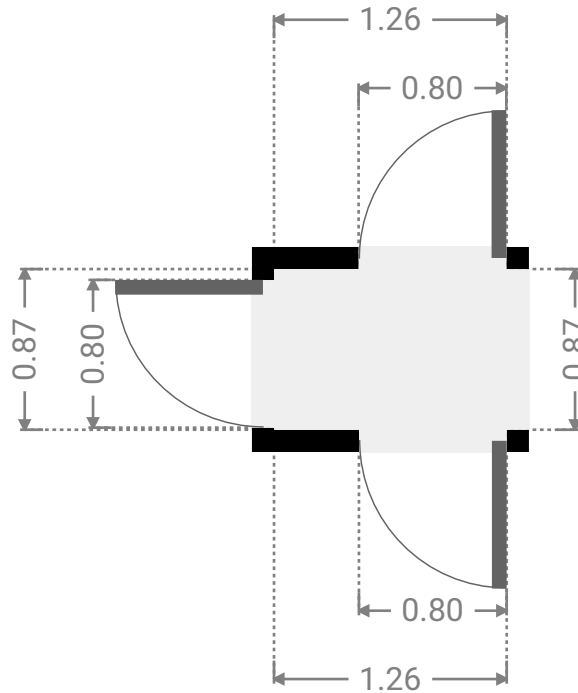

▼ Bathroom Ground Floor

WIDTH: 3.07 m • LENGTH: 1.77 m
AREA: 5.43 m² • PERIMETER: 9.68 m

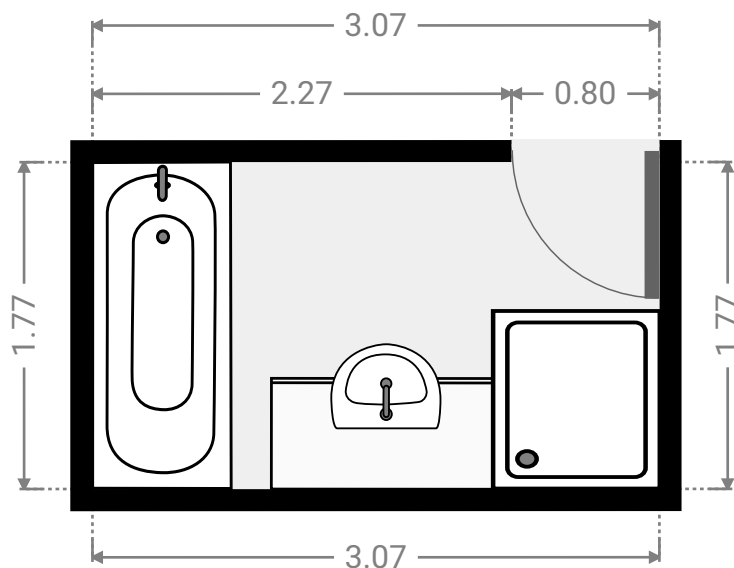

▼ **Hall**
Ground Floor

WIDTH: 1.45 m • LENGTH: 7.17 m
AREA: 7.74 m² • PERIMETER: 17.24 m

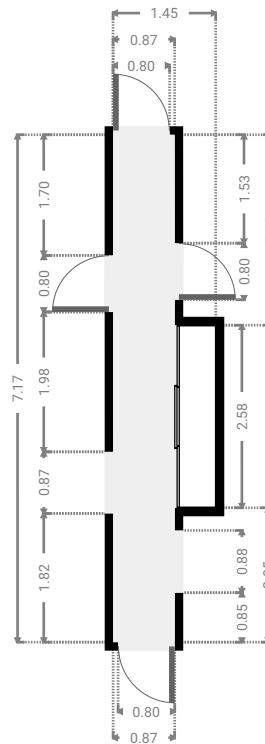

▼ **Kitchen**
Ground Floor

WIDTH: 6.98 m • LENGTH: 8.55 m
AREA: 55.04 m² • PERIMETER: 30.66 m

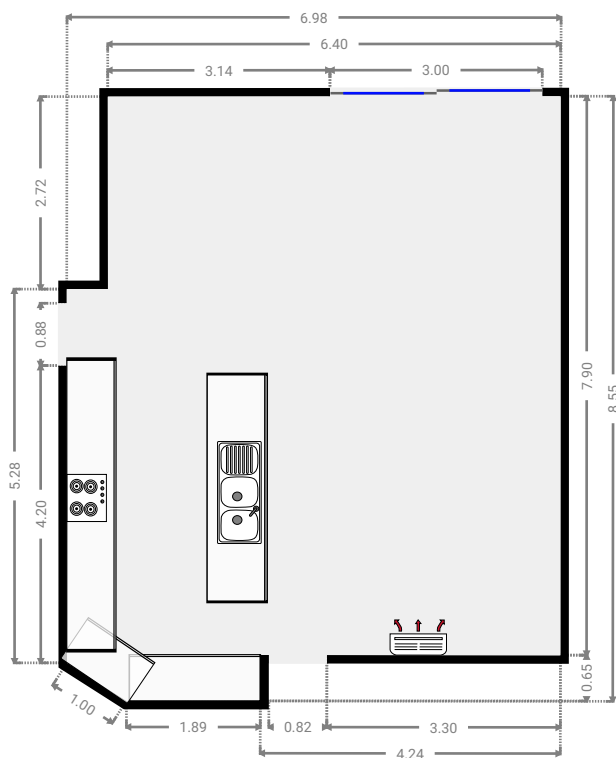
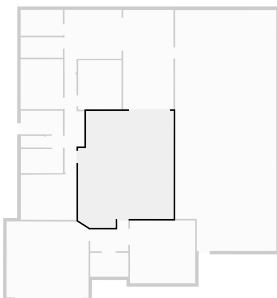

▼ Garage
Ground Floor

WIDTH: 6.00 m • LENGTH: 5.59 m
AREA: 33.16 m² • PERIMETER: 22.75 m

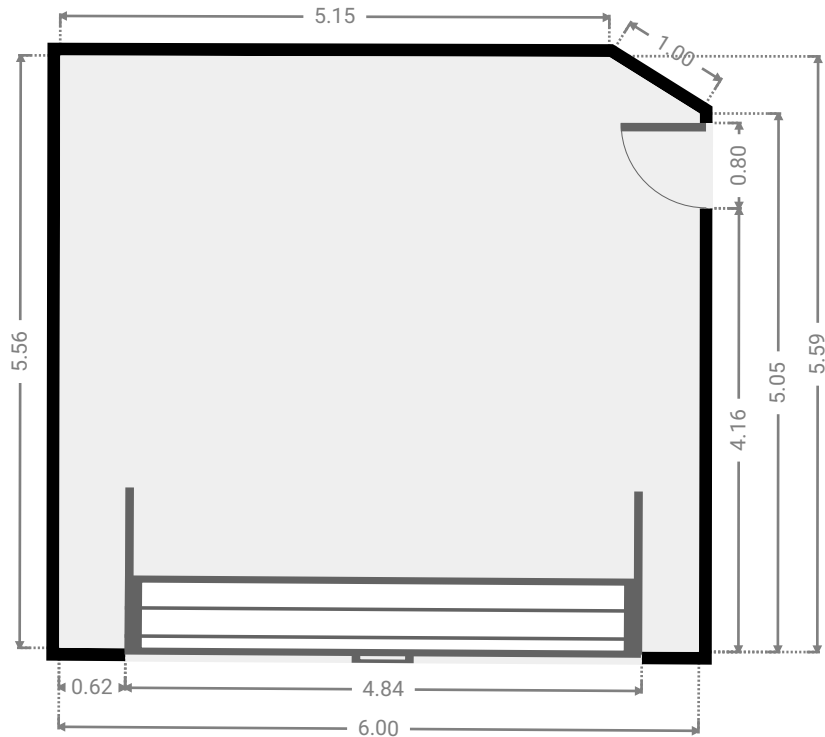
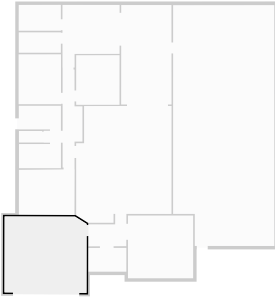

▼ Living Room
Ground Floor

WIDTH: 4.77 m • LENGTH: 4.59 m
AREA: 21.89 m² • PERIMETER: 18.72 m

