

# 10 Beltrees Place

Created on  
2021-07-22

Floors  
1

## ▼ Ground Floor



▼ **Hall**  
Ground Floor

WIDTH: 1.63 m • LENGTH: 3.58 m  
AREA: 5.83 m<sup>2</sup> • PERIMETER: 10.42 m

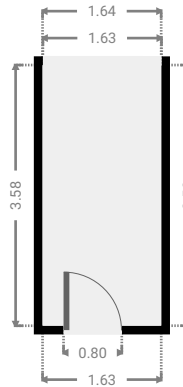

▼ **Kitchen**  
Ground Floor

WIDTH: 7.95 m • LENGTH: 7.71 m  
AREA: 52.99 m<sup>2</sup> • PERIMETER: 31.31 m

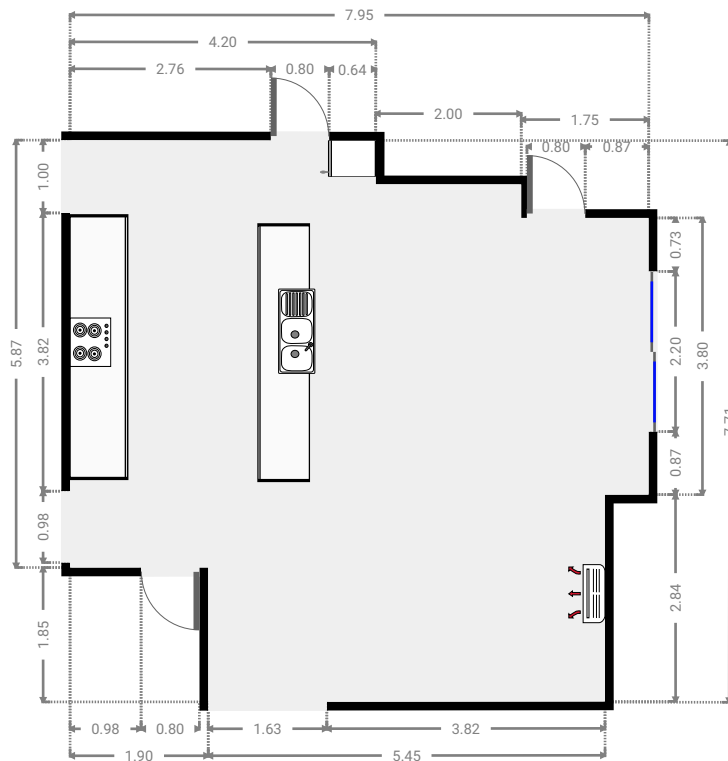
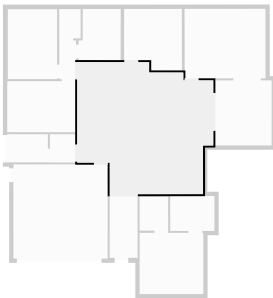

## ▼ Living Room Ground Floor

WIDTH: 4.73 m • LENGTH: 4.06 m  
AREA: 19.17 m<sup>2</sup> • PERIMETER: 17.57 m

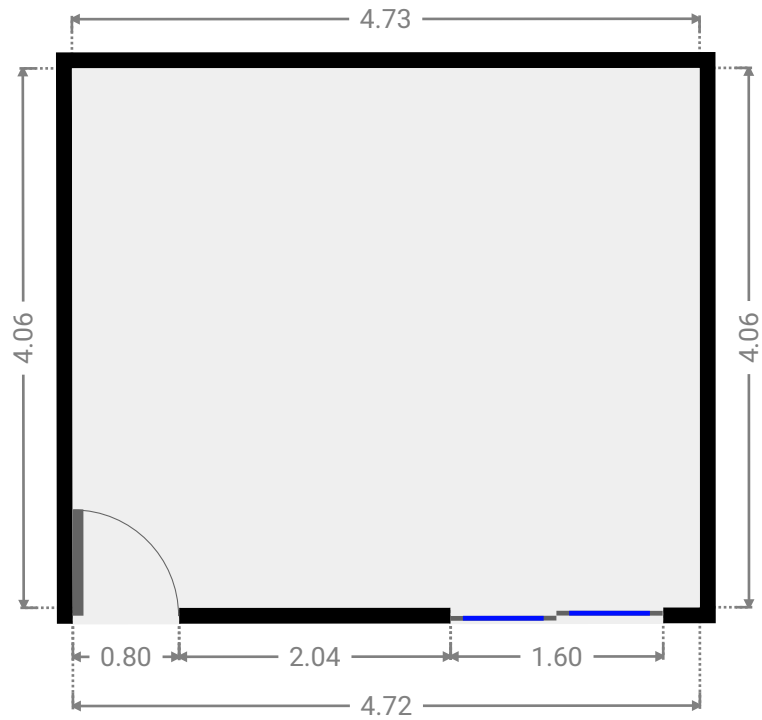

## ▼ Bedroom Ground Floor

WIDTH: 3.38 m • LENGTH: 3.60 m  
AREA: 11.18 m<sup>2</sup> • PERIMETER: 13.94 m

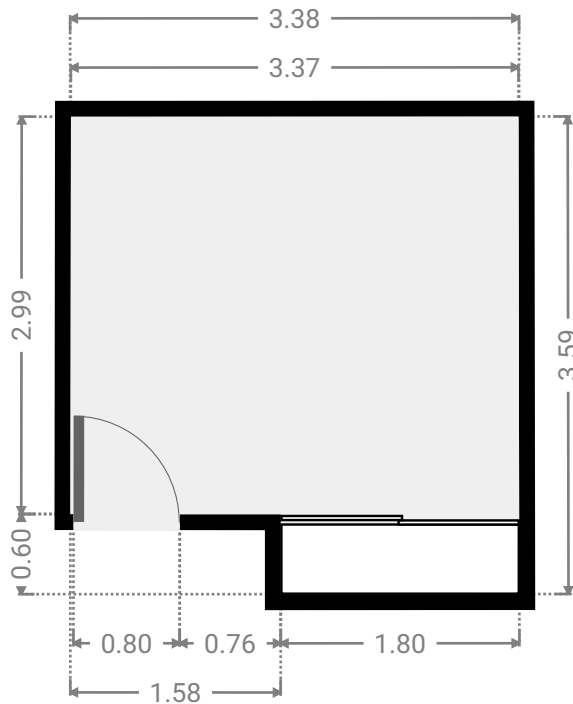
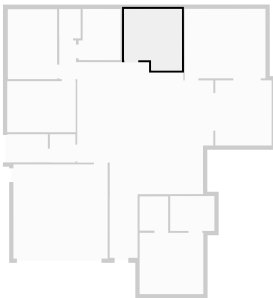

▼ **Hall**  
Ground Floor

WIDTH: 0.97 m • LENGTH: 2.26 m  
AREA: 2.19 m<sup>2</sup> • PERIMETER: 6.46 m

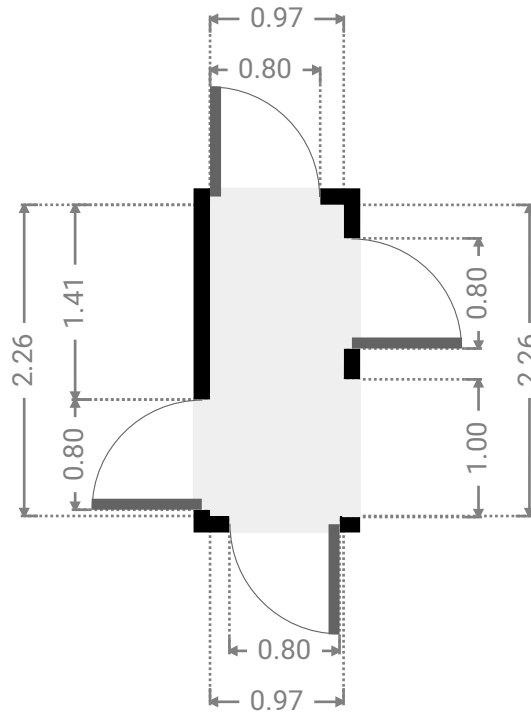
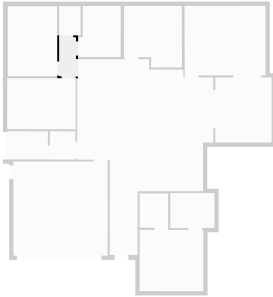

▼ **Bathroom**  
Ground Floor

WIDTH: 2.45 m • LENGTH: 2.99 m  
AREA: 6.89 m<sup>2</sup> • PERIMETER: 10.88 m

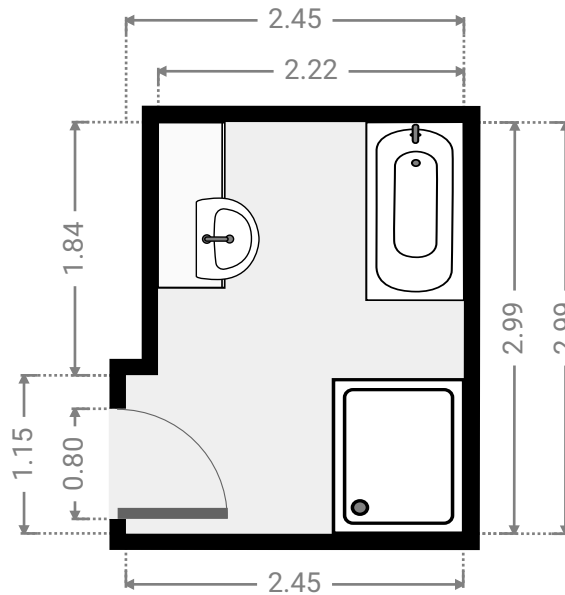
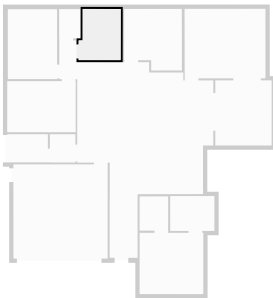

▼ **Toilet**  
Ground Floor

WIDTH: 1.25 m • LENGTH: 1.71 m  
AREA: 2.14 m<sup>2</sup> • PERIMETER: 5.92 m

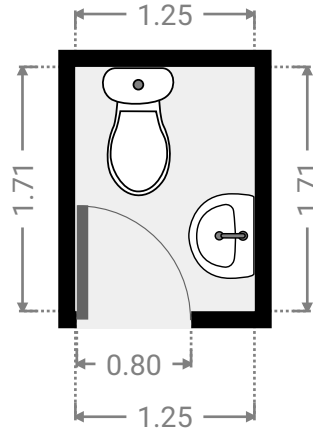
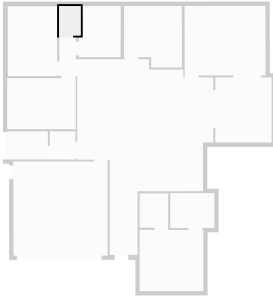

▼ **Bedroom**  
Ground Floor

WIDTH: 2.88 m • LENGTH: 4.08 m  
AREA: 11.75 m<sup>2</sup> • PERIMETER: 13.92 m

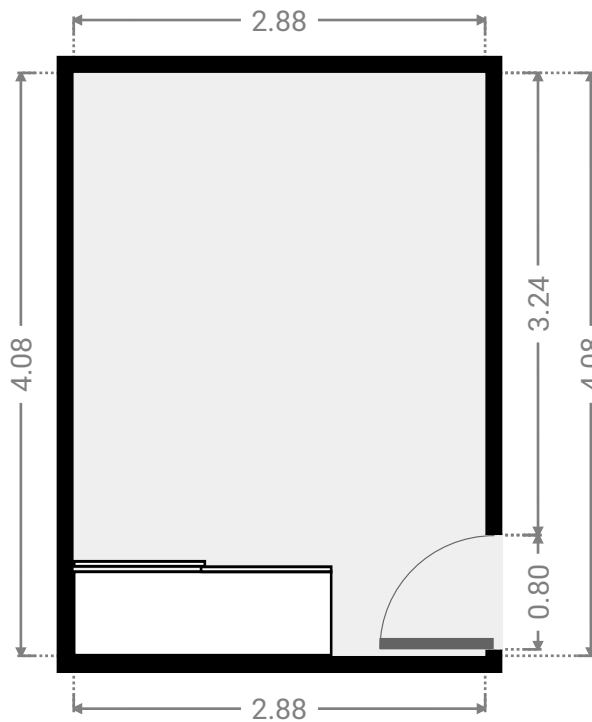
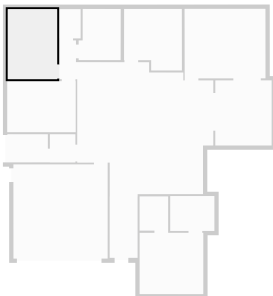

▼ **Bedroom**  
Ground Floor

WIDTH: 4.00 m • LENGTH: 2.98 m  
AREA: 11.91 m<sup>2</sup> • PERIMETER: 13.96 m

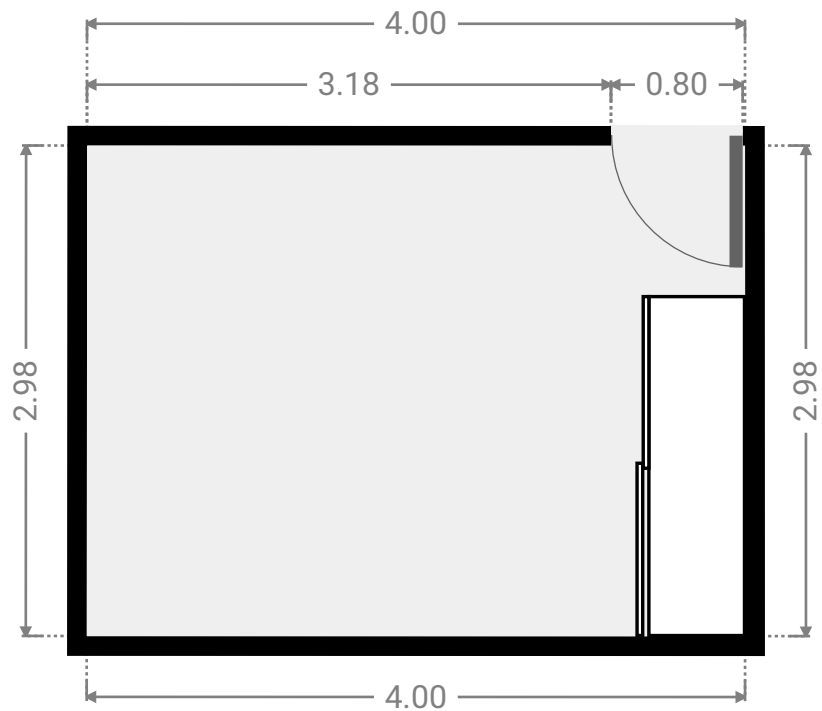
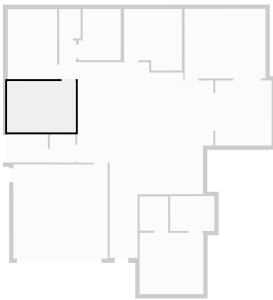

▼ **Laundry Room**  
Ground Floor

WIDTH: 1.49 m • LENGTH: 1.65 m  
AREA: 2.46 m<sup>2</sup> • PERIMETER: 6.28 m

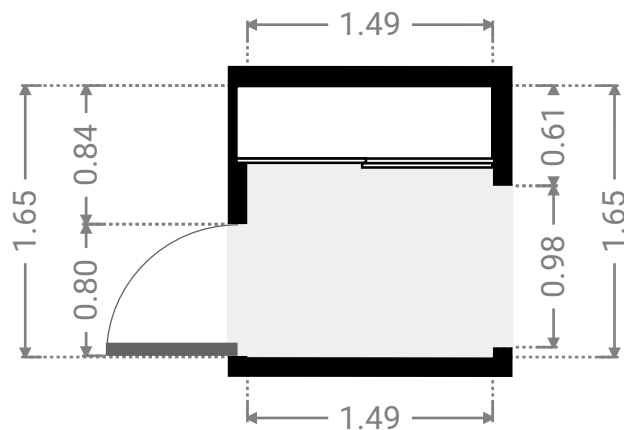
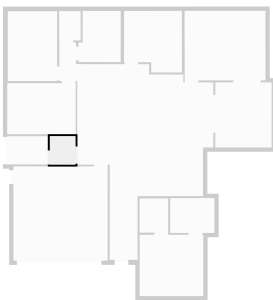

▼ Laundry Room  
Ground Floor

WIDTH: 2.37 m • LENGTH: 1.65 m  
AREA: 3.89 m<sup>2</sup> • PERIMETER: 8.02 m

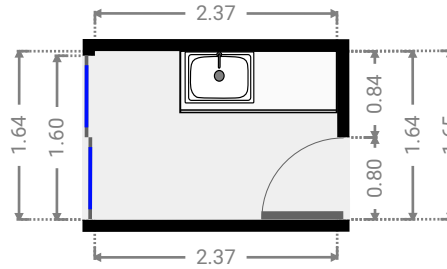
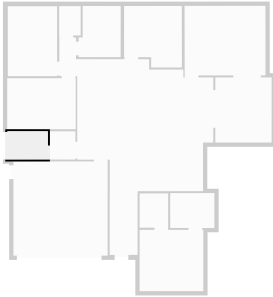

▼ Garage  
Ground Floor

WIDTH: 5.51 m • LENGTH: 5.50 m  
AREA: 30.27 m<sup>2</sup> • PERIMETER: 22.01 m

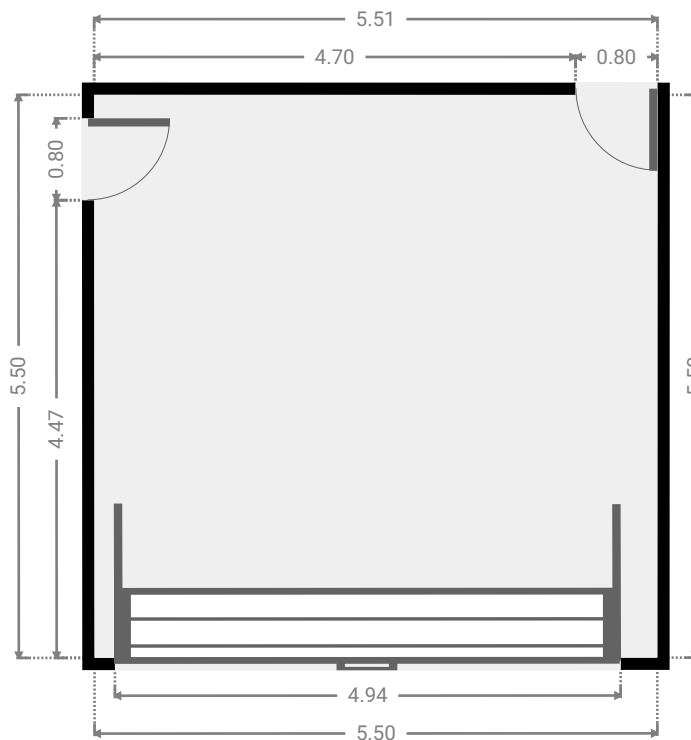
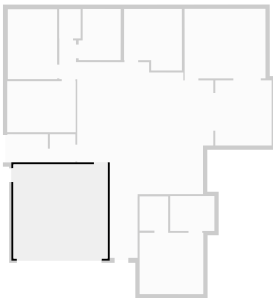



▼ **Master Bedroom**  
Ground Floor

WIDTH: 3.72 m • LENGTH: 3.58 m  
AREA: 13.32 m<sup>2</sup> • PERIMETER: 14.60 m

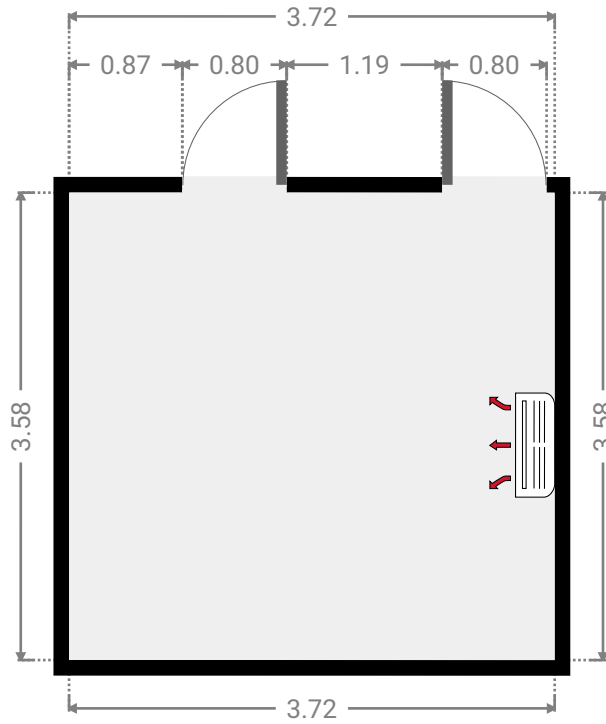
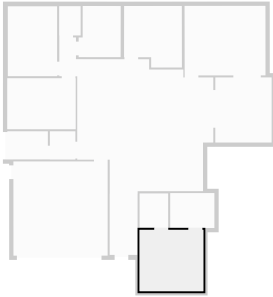

▼ **Closet**  
Ground Floor

WIDTH: 1.67 m • LENGTH: 2.00 m  
AREA: 3.34 m<sup>2</sup> • PERIMETER: 7.34 m

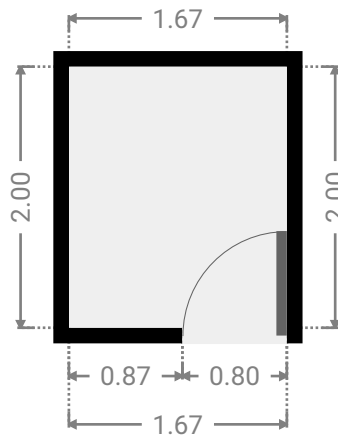
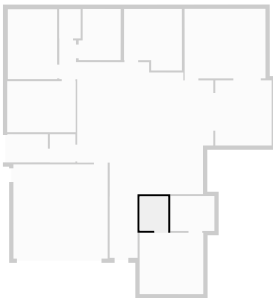

▼ Bathroom  
Ground Floor

WIDTH: 2.58 m • LENGTH: 2.04 m  
AREA: 5.26 m<sup>2</sup> • PERIMETER: 9.24 m

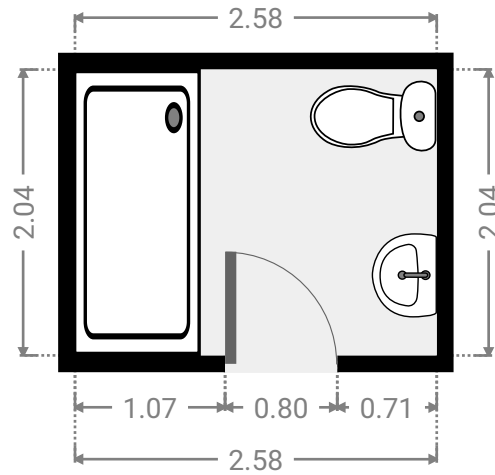
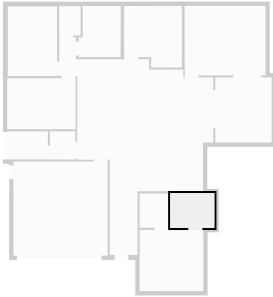

▼ Other  
Ground Floor

WIDTH: 3.29 m • LENGTH: 3.80 m  
AREA: 12.50 m<sup>2</sup> • PERIMETER: 14.18 m

