

10 Beaumont Drive

Ground Floor

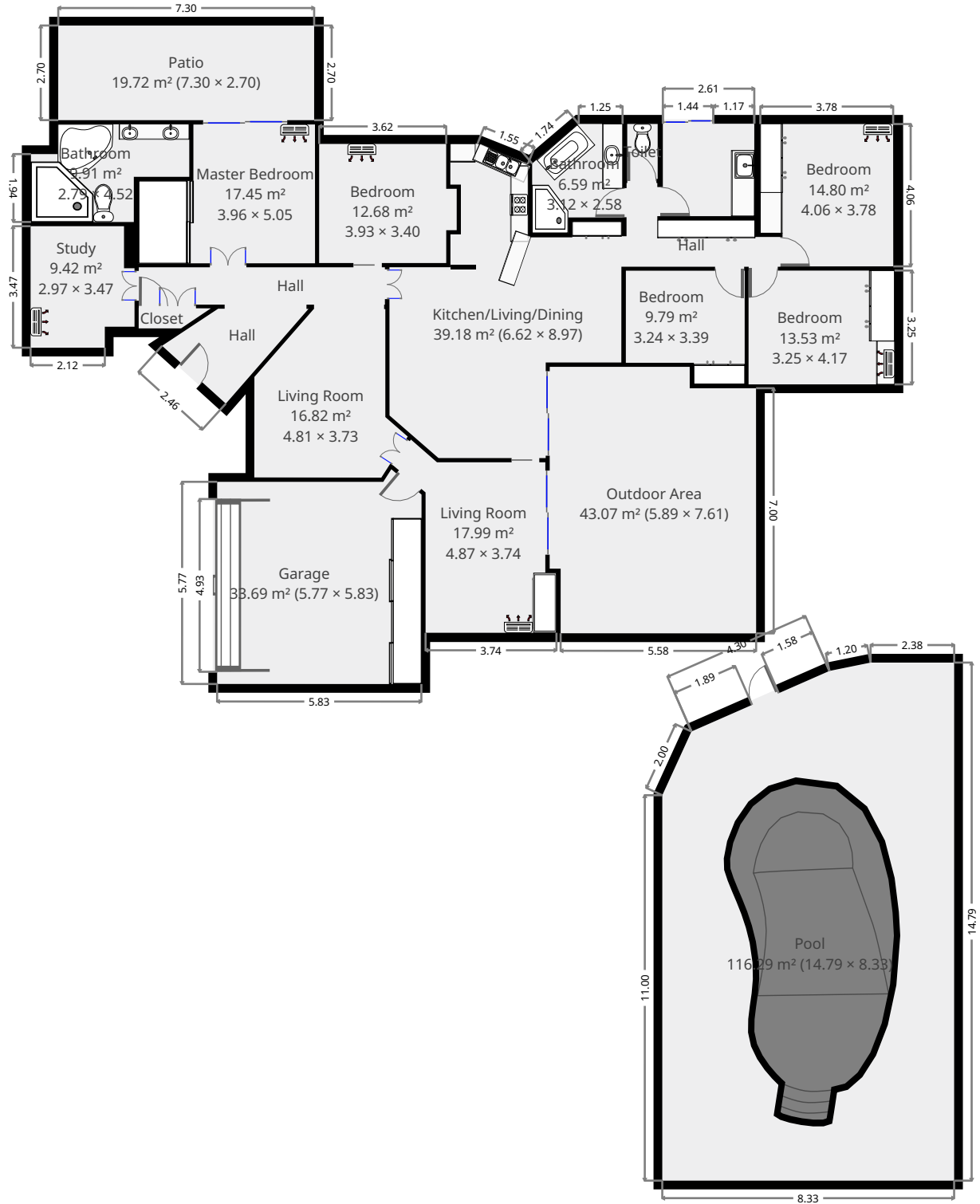

THIS FLOORPLAN IS PROVIDED WITHOUT WARRANTY OF ANY KIND. SENSOPIA DISCLAIMS ANY WARRANTY INCLUDING, WITHOUT LIMITATION, SATISFACTORY QUALITY OR ACCURACY OF DIMENSIONS.



10 Beaumont Drive

Garage

Width: 5.77 m
Length: 5.83 m
Area: 33.69 m²
Perimeter: 23.30 m

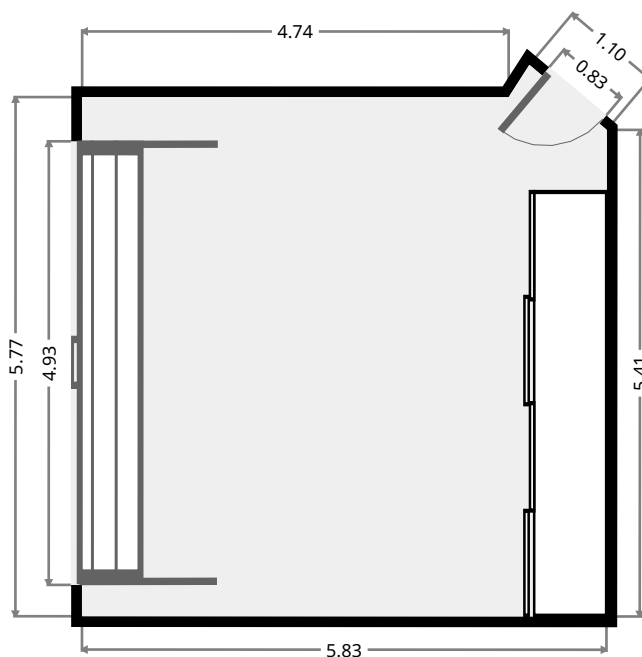
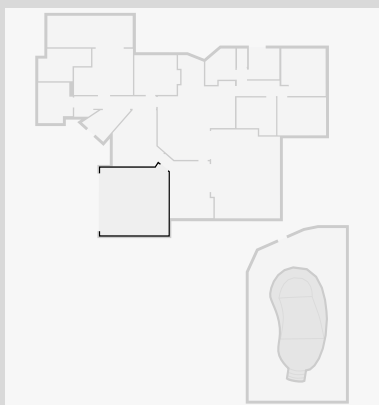

Patio

Width: 2.70 m
Length: 7.30 m
Area: 19.72 m²
Perimeter: 20.01 m

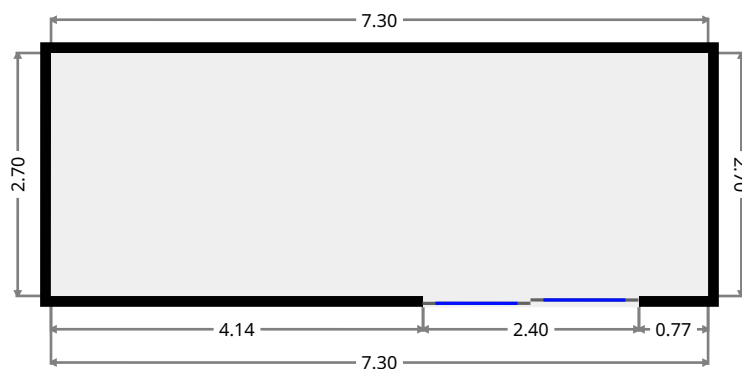
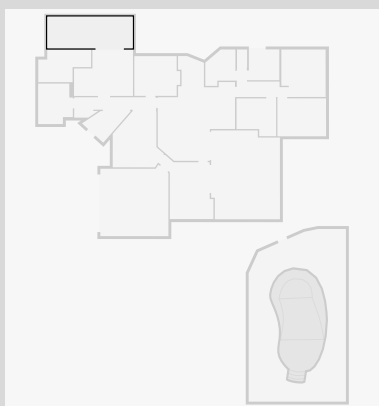

10 Beaumont Drive

Pool

Width: 8.33 m
Length: 14.79 m
Area: 116.29 m²
Perimeter: 44.00 m

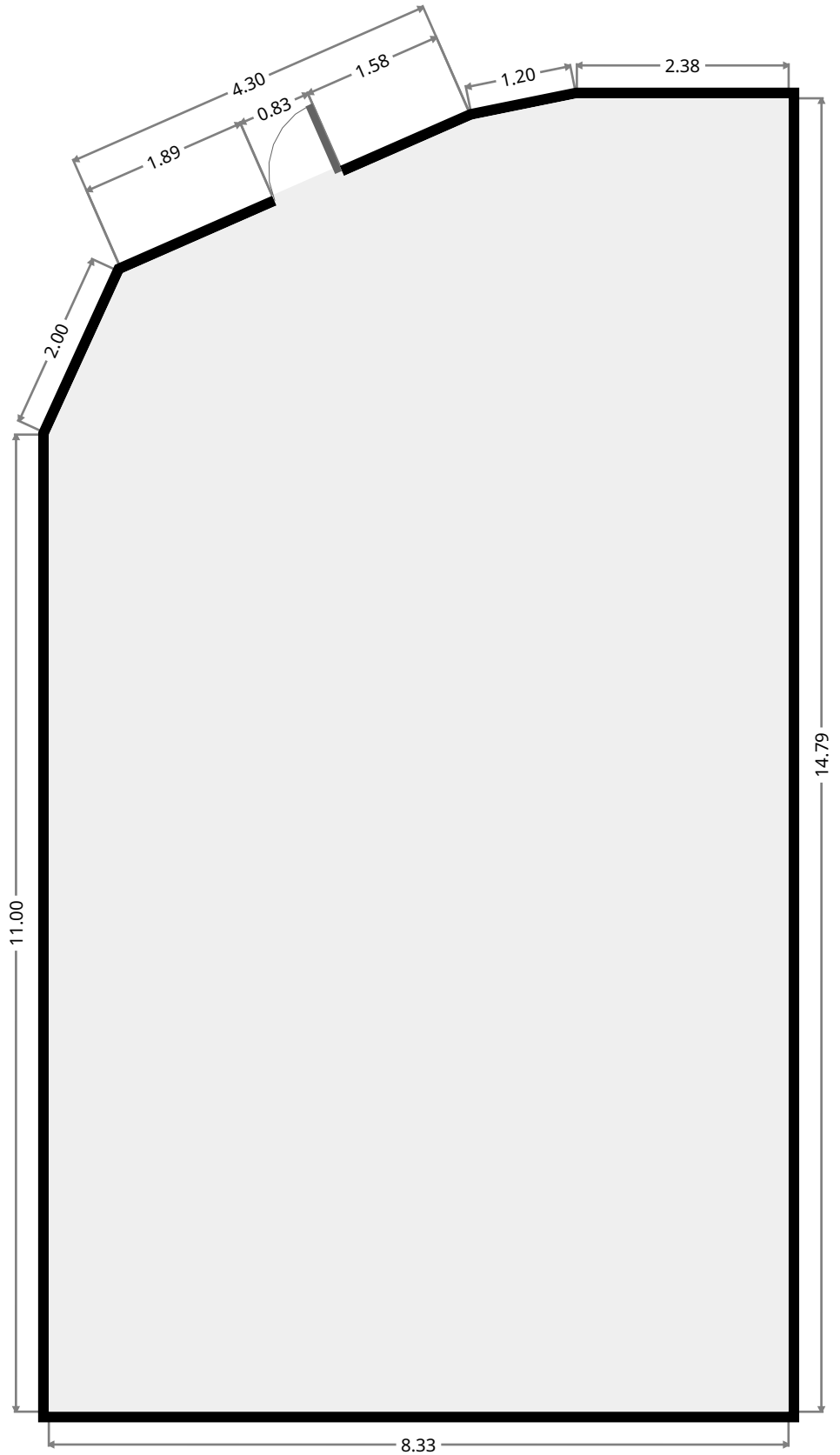
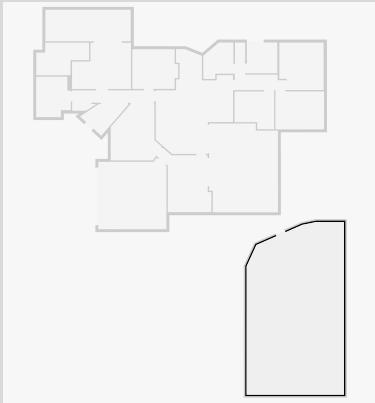

THIS FLOORPLAN IS PROVIDED WITHOUT WARRANTY OF ANY KIND. SENSOPIA DISCLAIMS ANY WARRANTY INCLUDING, WITHOUT LIMITATION, SATISFACTORY QUALITY OR ACCURACY OF DIMENSIONS.



10 Beaumont Drive

Outdoor Area

Width: 5.89 m
 Length: 7.61 m
 Area: 43.07 m²
 Perimeter: 27.00 m

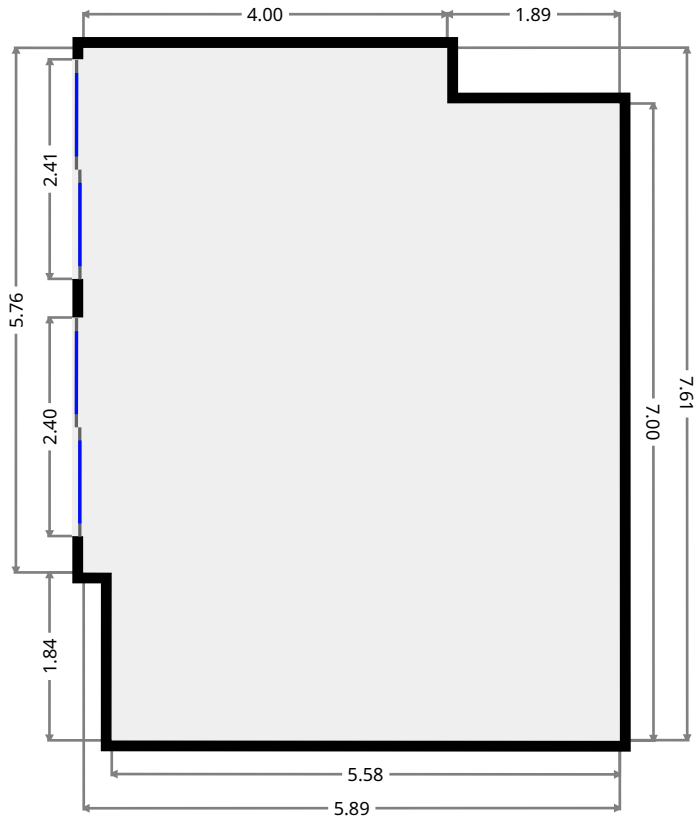
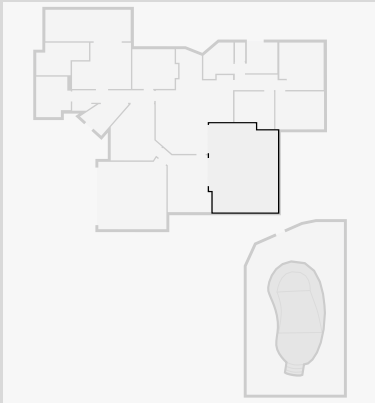

Laundry Room

Width: 2.60 m
 Length: 2.64 m
 Area: 6.89 m²
 Perimeter: 10.50 m

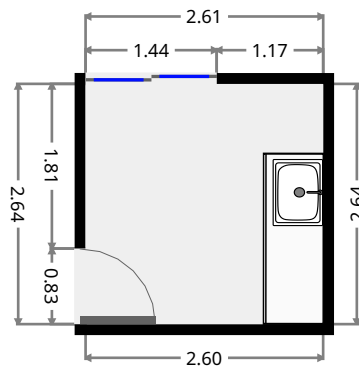
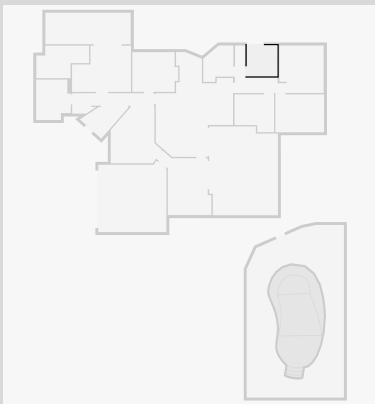

10 Beaumont Drive

Bedroom

Width: 3.78 m
 Length: 4.06 m
 Area: 14.80 m²
 Perimeter: 15.71 m

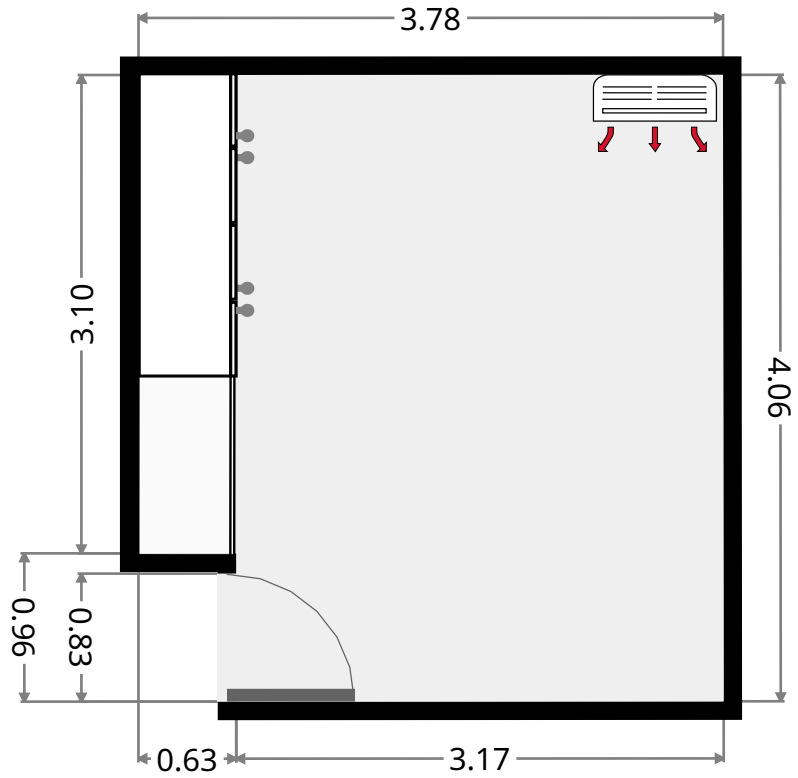
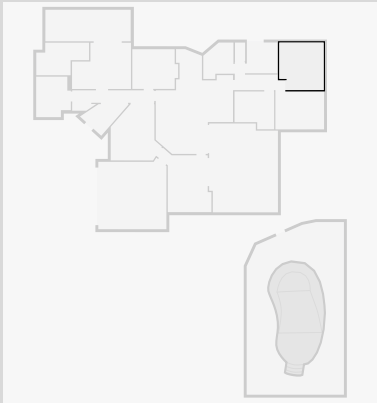

Bathroom

Width: 2.58 m
 Length: 3.12 m
 Area: 6.59 m²
 Perimeter: 10.67 m

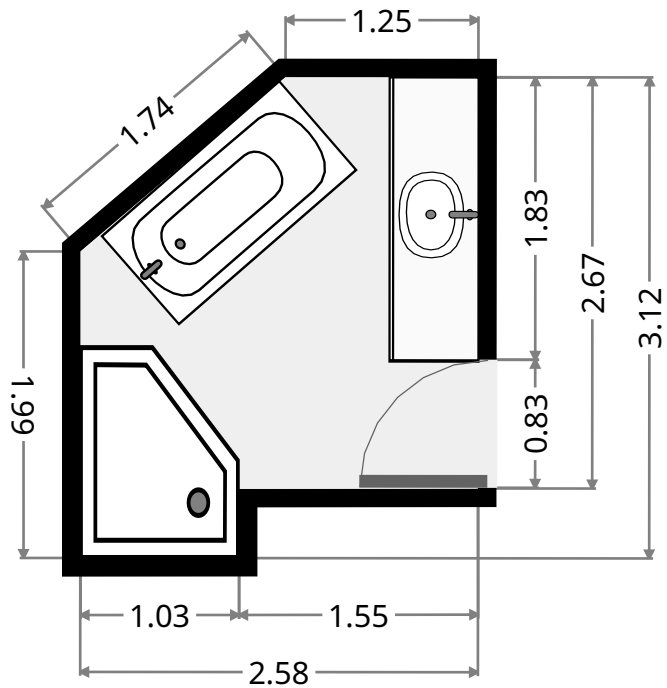
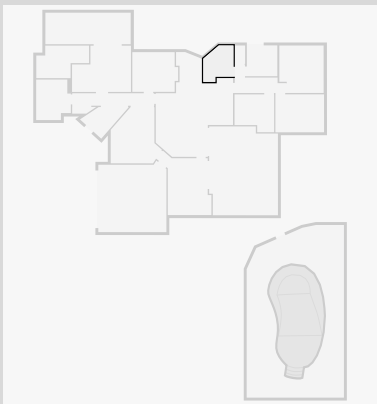

THIS FLOORPLAN IS PROVIDED WITHOUT WARRANTY OF ANY KIND. SENSOPIA DISCLAIMS ANY WARRANTY INCLUDING, WITHOUT LIMITATION, SATISFACTORY QUALITY OR ACCURACY OF DIMENSIONS.

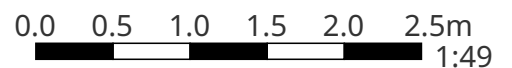

10 Beaumont Drive

Toilet

Width: 0.86 m
 Length: 1.57 m
 Area: 1.36 m²
 Perimeter: 4.87 m

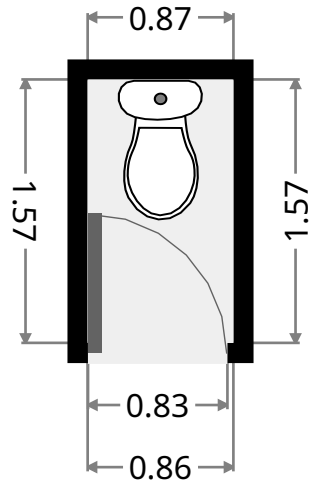
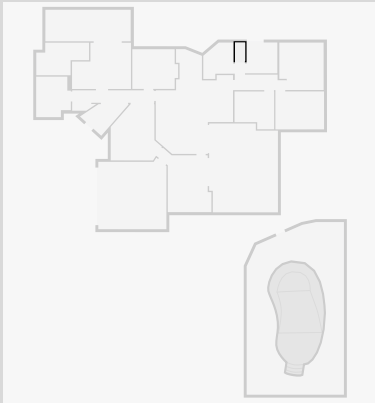

Bedroom

Width: 3.25 m
 Length: 4.17 m
 Area: 13.53 m²
 Perimeter: 14.83 m

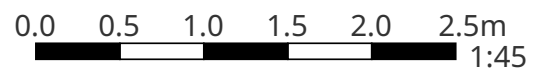
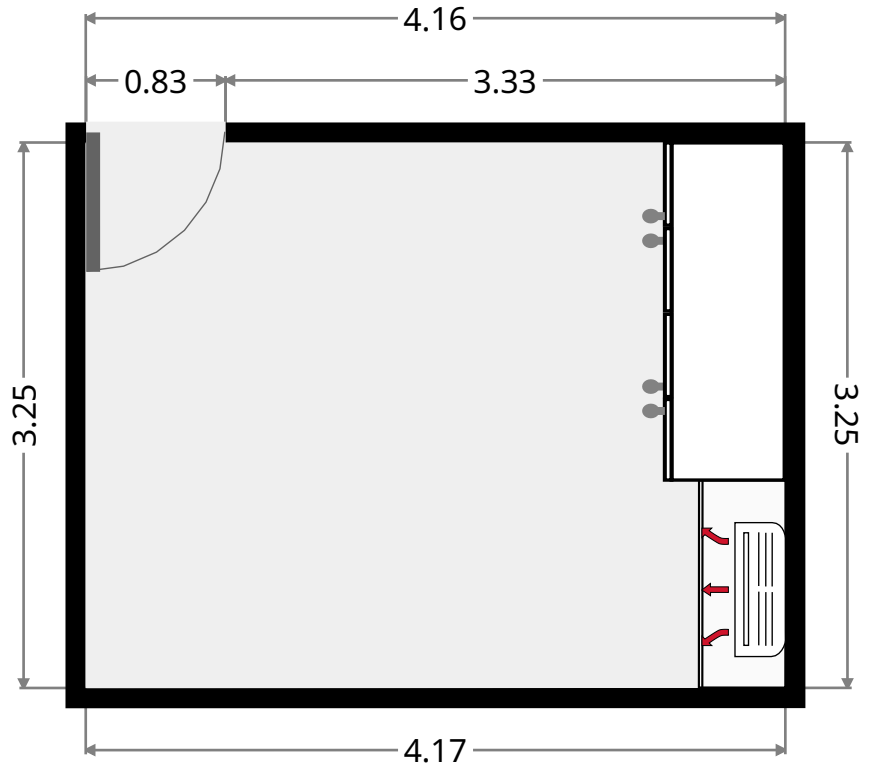
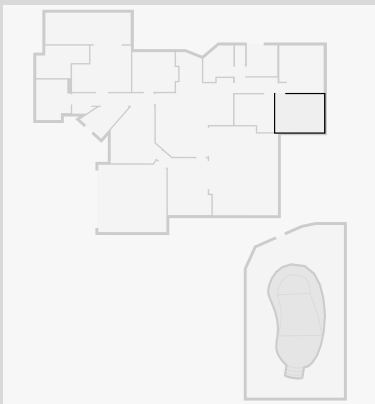

THIS FLOORPLAN IS PROVIDED WITHOUT WARRANTY OF ANY KIND. SENSOPIA DISCLAIMS ANY WARRANTY INCLUDING, WITHOUT LIMITATION, SATISFACTORY QUALITY OR ACCURACY OF DIMENSIONS.

10 Beaumont Drive

Bedroom

Width: 3.24 m
 Length: 3.39 m
 Area: 9.79 m²
 Perimeter: 13.26 m

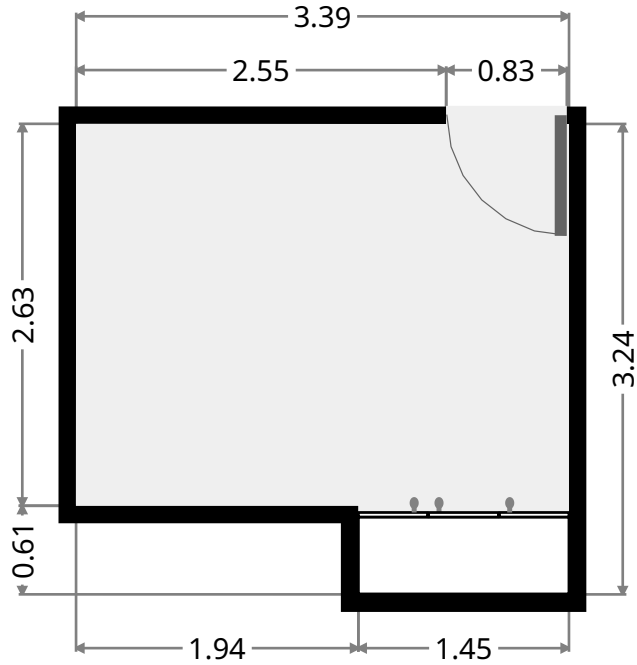
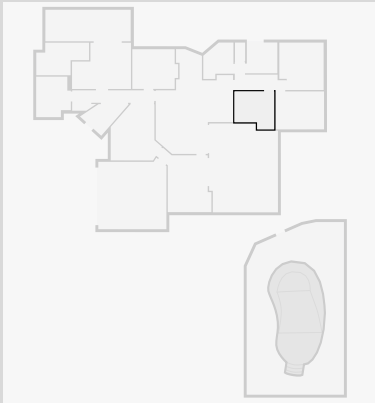

Hall

Width: 2.39 m
 Length: 4.40 m
 Area: 6.42 m²
 Perimeter: 13.56 m

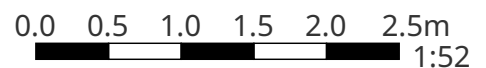
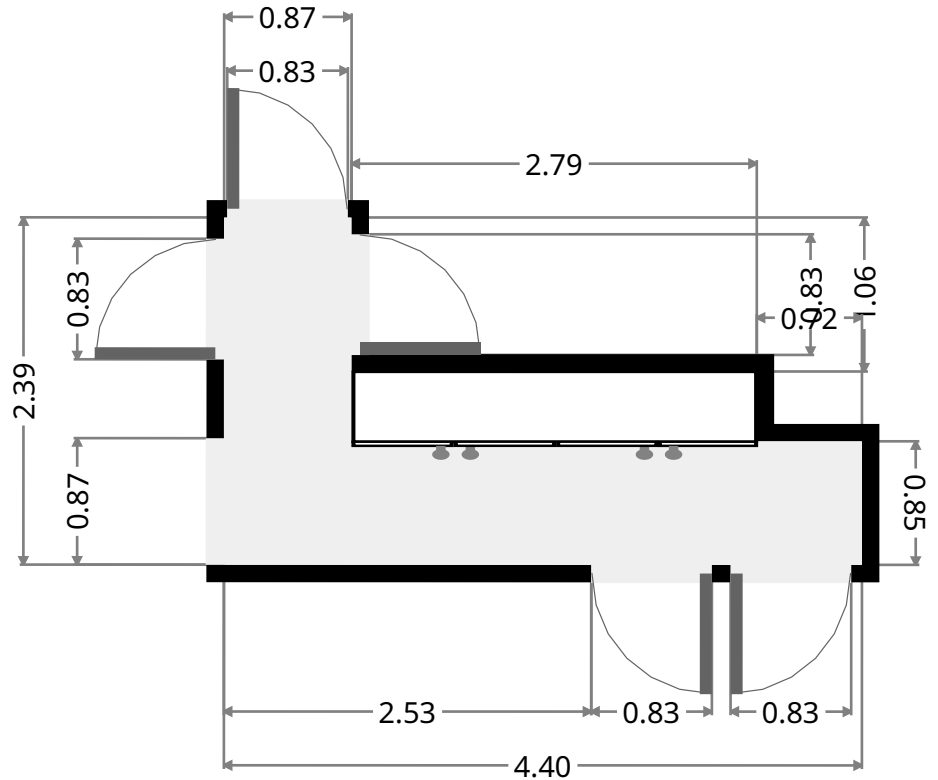
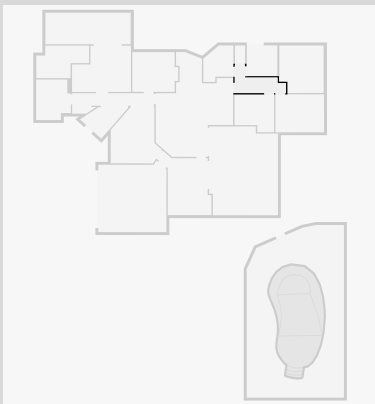

THIS FLOORPLAN IS PROVIDED WITHOUT WARRANTY OF ANY KIND. SENSOPIA DISCLAIMS ANY WARRANTY INCLUDING, WITHOUT LIMITATION, SATISFACTORY QUALITY OR ACCURACY OF DIMENSIONS.

10 Beaumont Drive

Living Room

Width: 3.73 m
 Length: 4.81 m
 Area: 16.82 m²
 Perimeter: 16.43 m

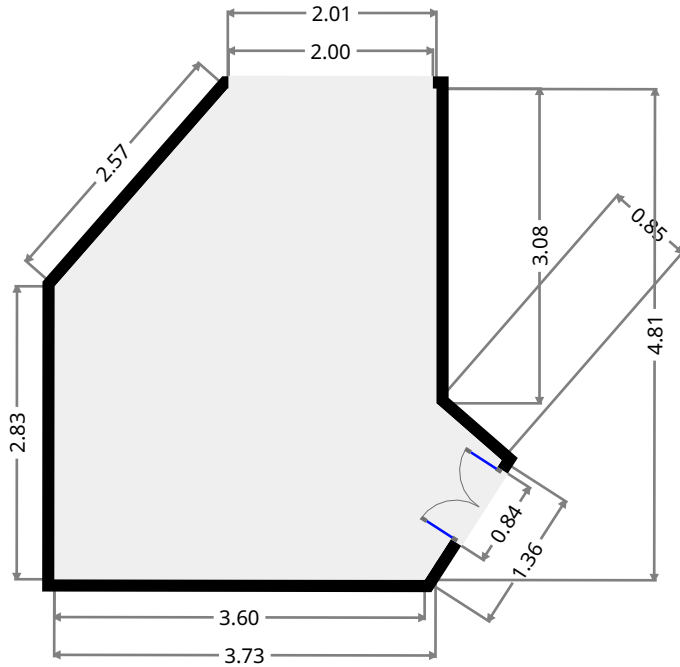
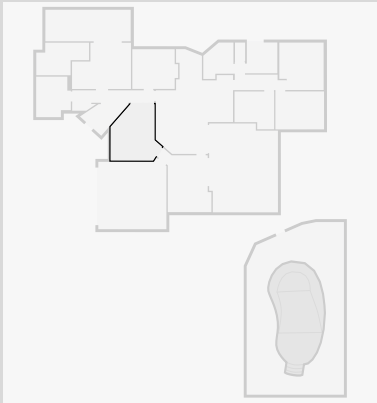

Living Room

Width: 3.74 m
 Length: 4.87 m
 Area: 17.99 m²
 Perimeter: 19.09 m

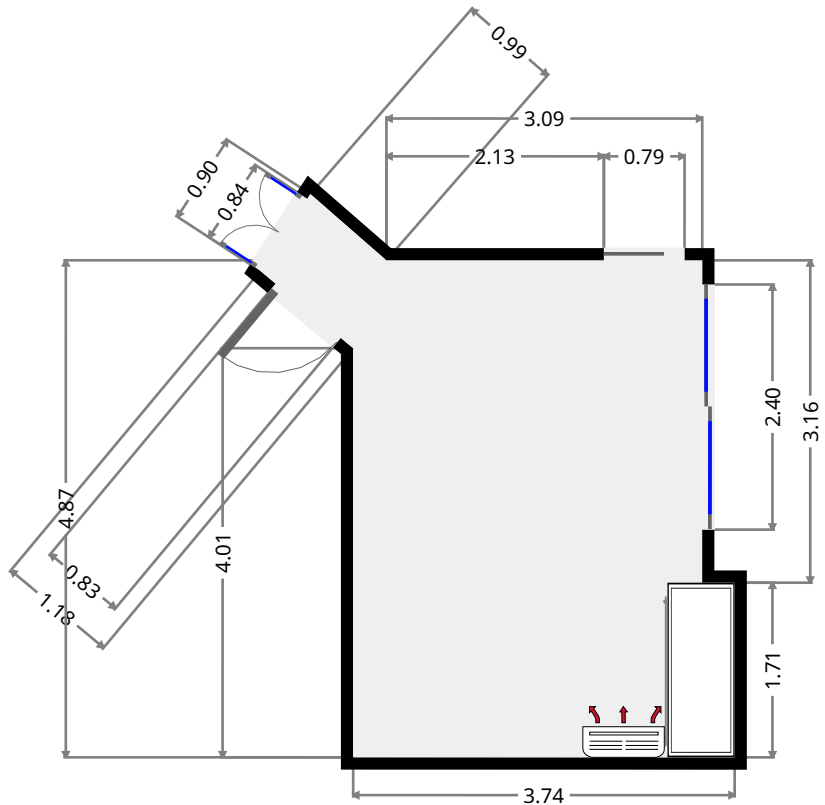
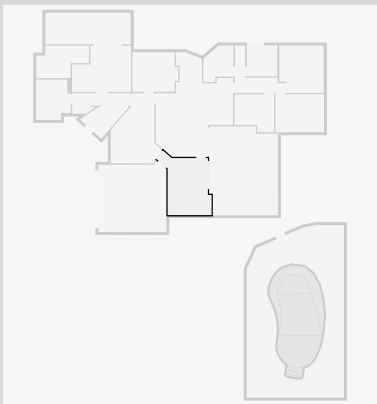

THIS FLOORPLAN IS PROVIDED WITHOUT WARRANTY OF ANY KIND. SENSOPIA DISCLAIMS ANY WARRANTY INCLUDING, WITHOUT LIMITATION, SATISFACTORY QUALITY OR ACCURACY OF DIMENSIONS.

10 Beaumont Drive

Kitchen/Living/Dining

Width: 6.62 m
 Length: 8.97 m
 Area: 39.18 m²
 Perimeter: 31.46 m

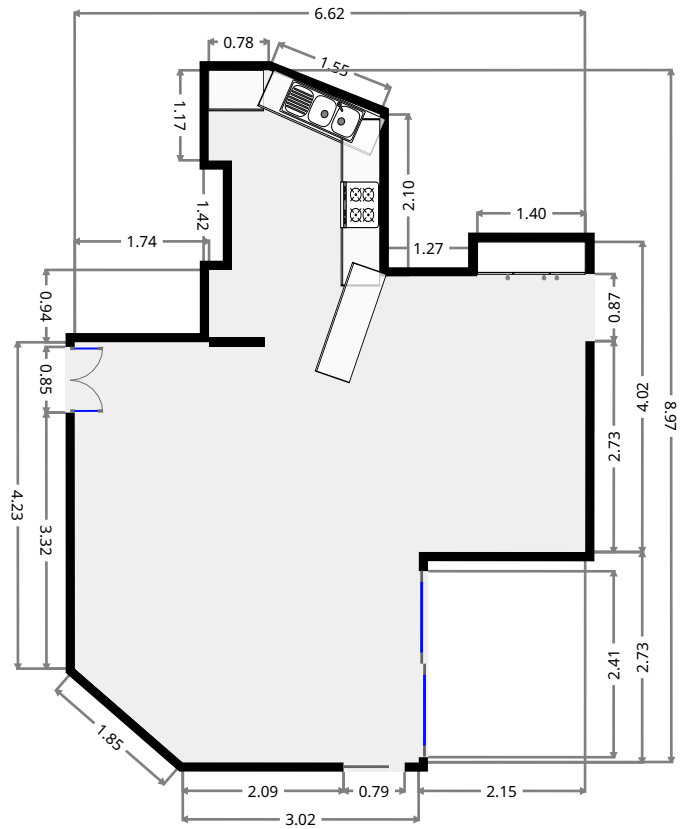
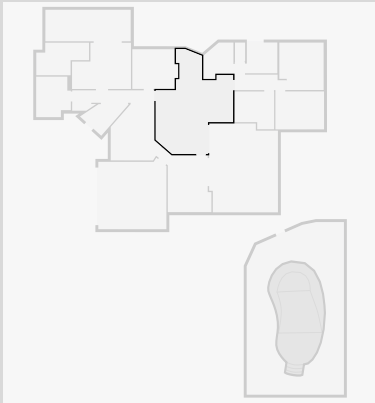

Bedroom

Width: 3.40 m
 Length: 3.93 m
 Area: 12.68 m²
 Perimeter: 14.65 m

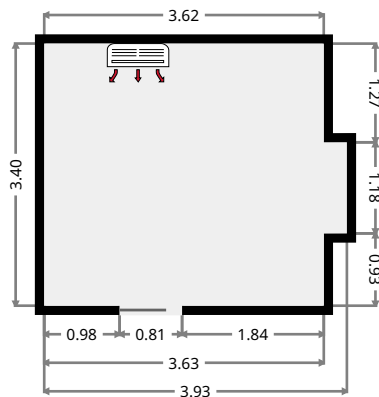
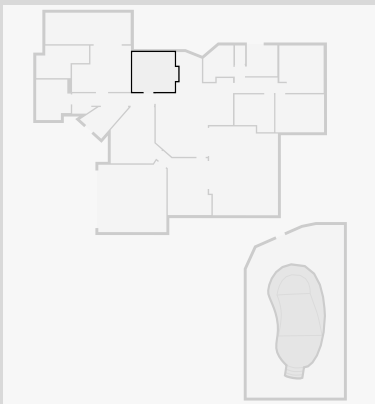

10 Beaumont Drive

Bathroom

Width: 2.79 m
 Length: 4.52 m
 Area: 9.91 m²
 Perimeter: 14.62 m

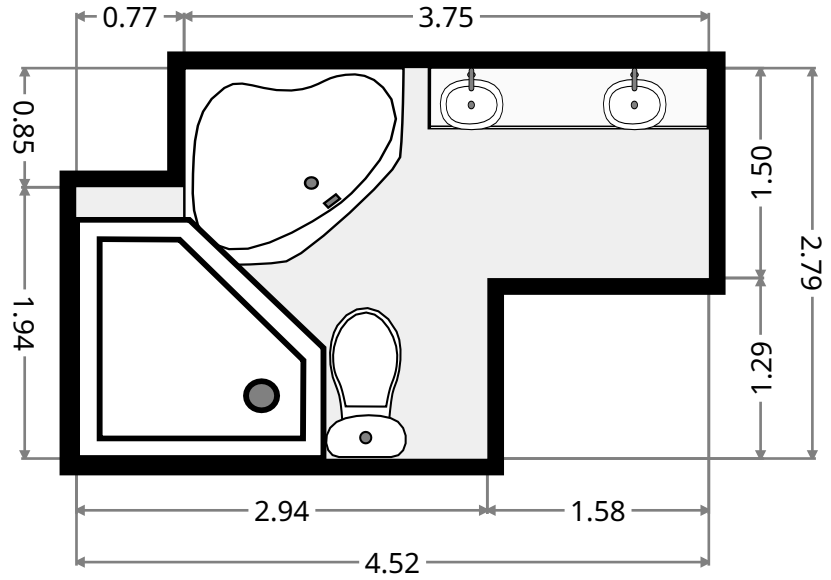
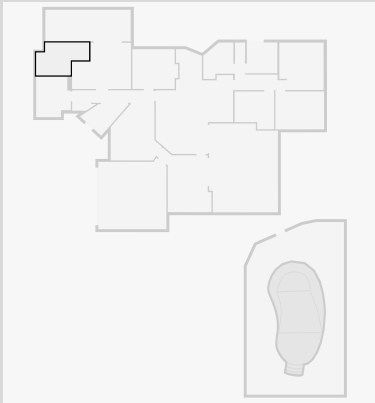

Master Bedroom

Width: 3.96 m
 Length: 5.05 m
 Area: 17.45 m²
 Perimeter: 18.01 m

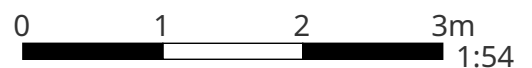
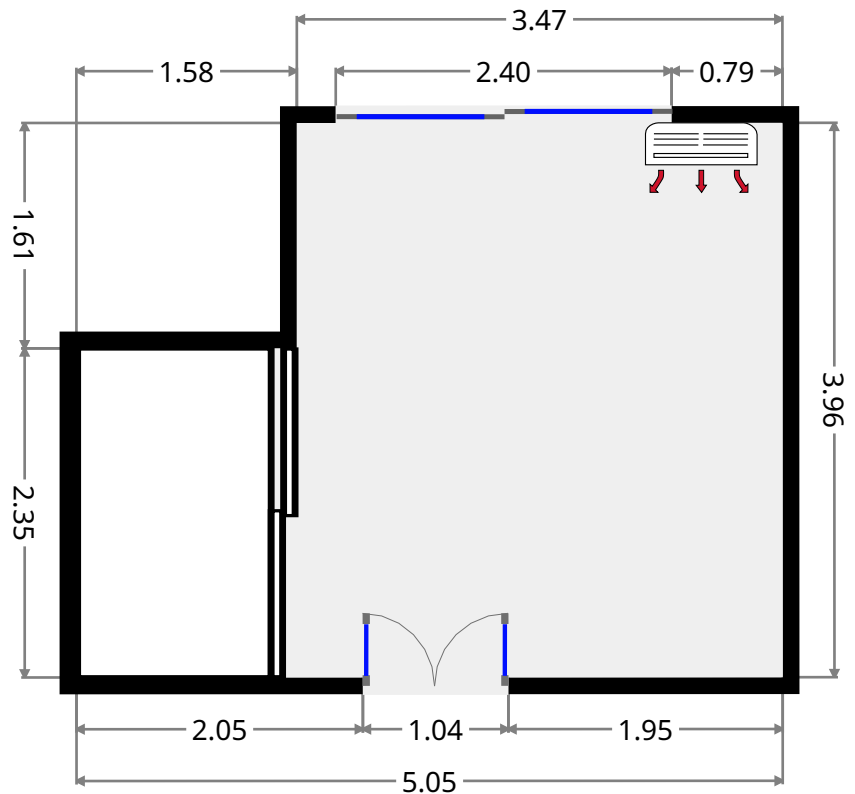
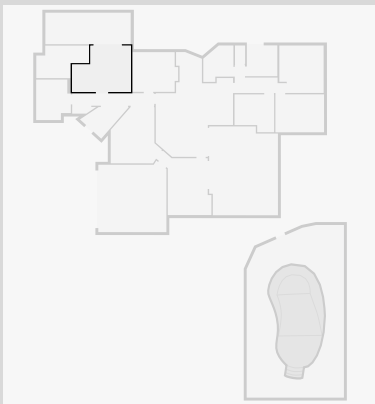

THIS FLOORPLAN IS PROVIDED WITHOUT WARRANTY OF ANY KIND. SENSOPIA DISCLAIMS ANY WARRANTY INCLUDING, WITHOUT LIMITATION, SATISFACTORY QUALITY OR ACCURACY OF DIMENSIONS.

10 Beaumont Drive

Hall

Width: 2.46 m
 Length: 3.59 m
 Area: 5.78 m²
 Perimeter: 10.54 m

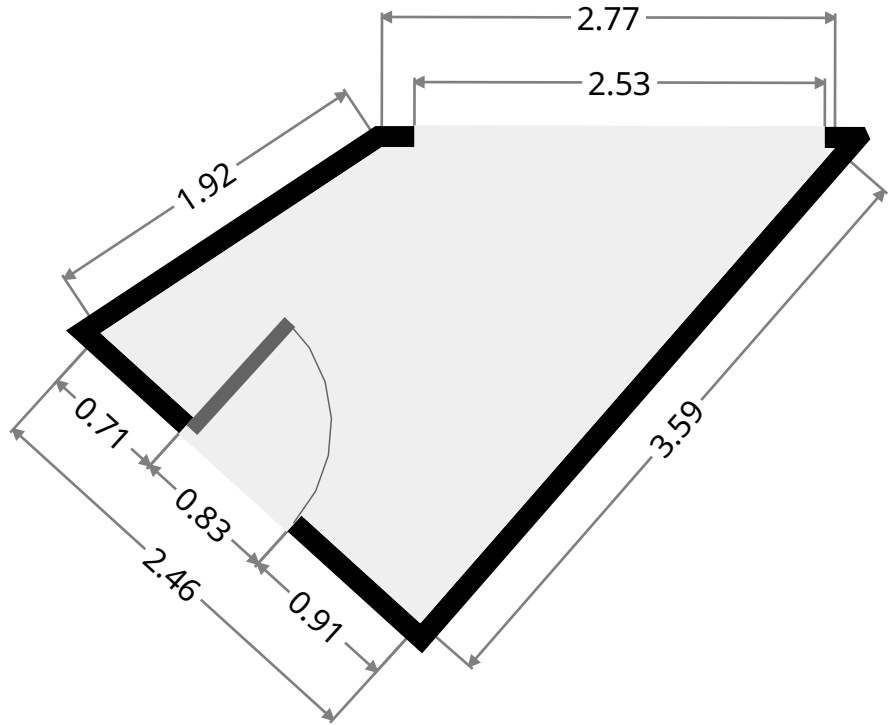
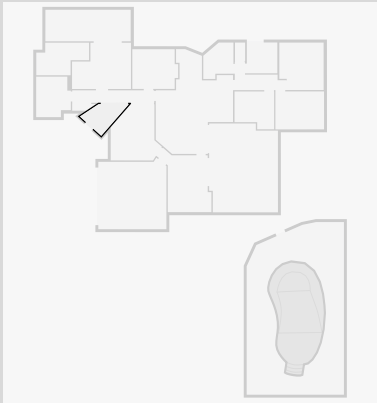

Closet

Width: 0.59 m
 Length: 2.06 m
 Area: 0.94 m²
 Perimeter: 4.87 m

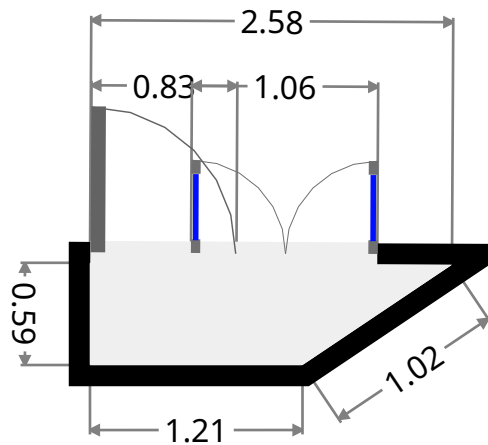
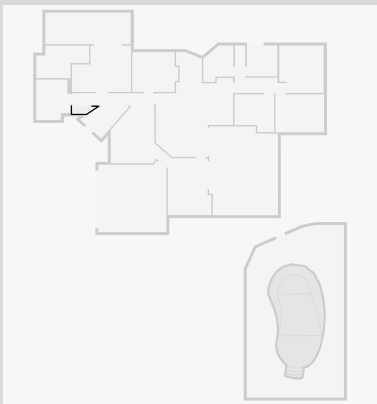

10 Beaumont Drive

Study

Width: 2.97 m
 Length: 3.47 m
 Area: 9.42 m²
 Perimeter: 12.87 m

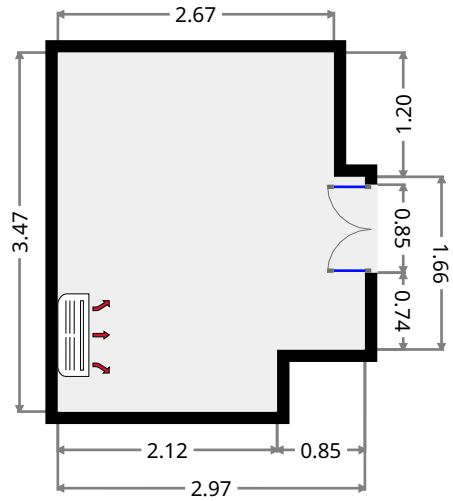
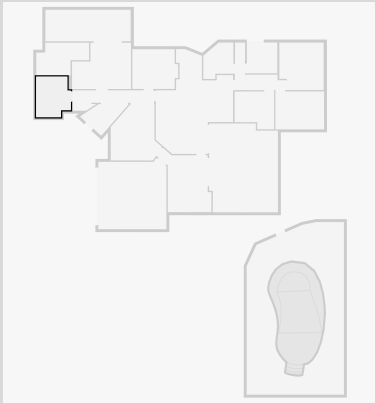

Hall

Width: 1.07 m
 Length: 7.02 m
 Area: 7.48 m²
 Perimeter: 16.18 m

