

10 Allen Road

Ground Floor

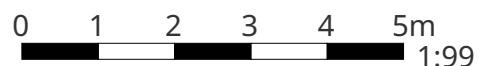

THIS FLOORPLAN IS PROVIDED WITHOUT WARRANTY OF ANY KIND. SENSOPIA DISCLAIMS ANY WARRANTY INCLUDING, WITHOUT LIMITATION, SATISFACTORY QUALITY OR ACCURACY OF DIMENSIONS.



10 Allen Road

Living Room

Width: 3.27 m
 Length: 4.97 m
 Area: 15.39 m²
 Perimeter: 16.13 m

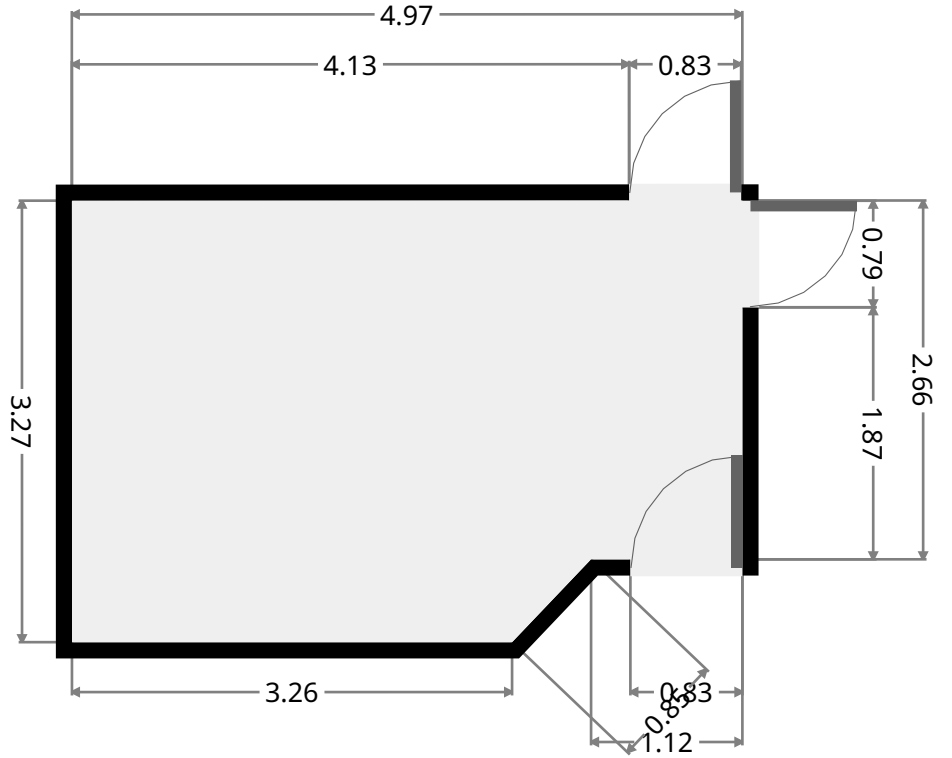
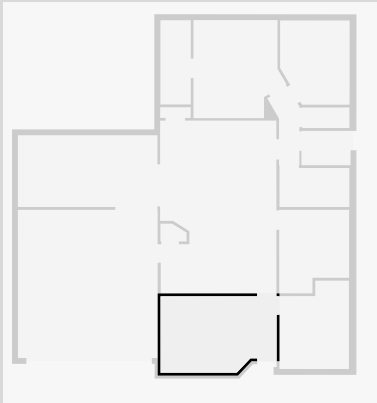

Bedroom

Width: 2.97 m
 Length: 3.78 m
 Area: 10.22 m²
 Perimeter: 13.50 m

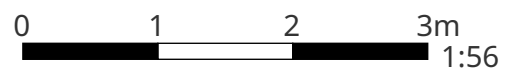
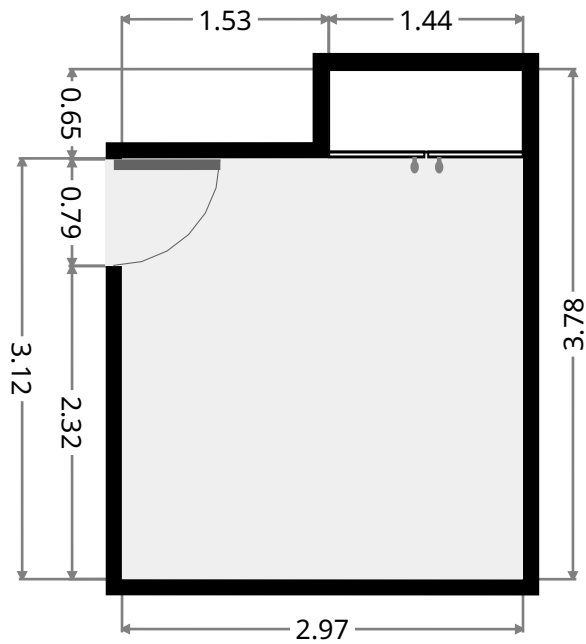
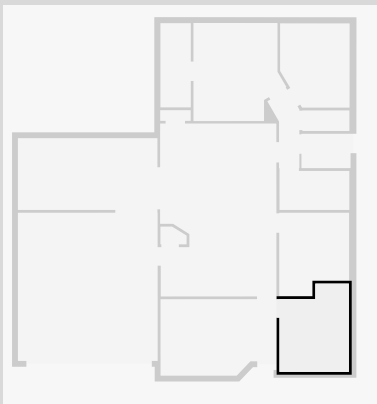

10 Allen Road

Kitchen/Living/Dining

Width: 4.97 m
 Length: 7.40 m
 Area: 35.65 m²
 Perimeter: 26.88 m

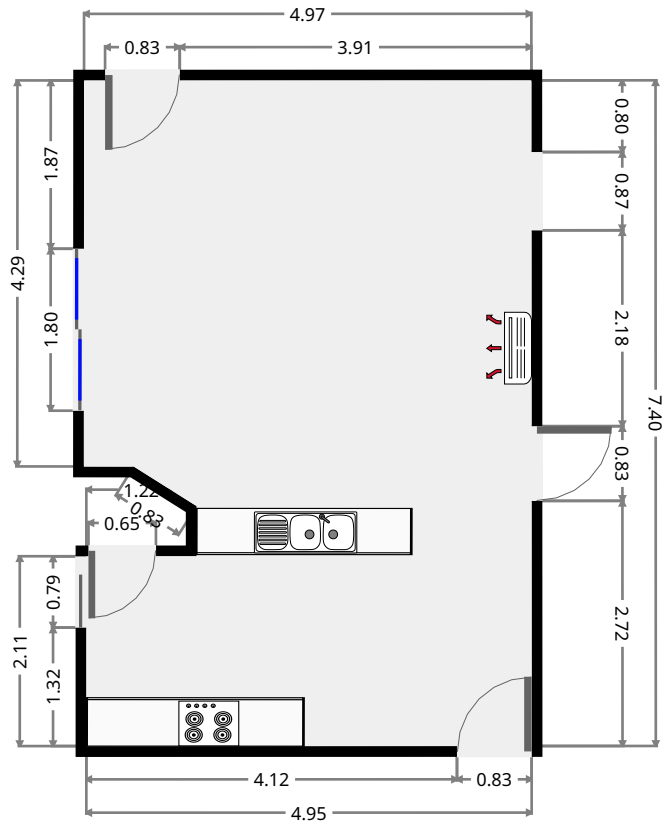
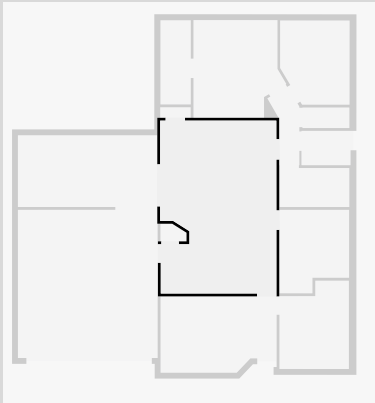

Closet

Width: 0.76 m
 Length: 1.12 m
 Area: 0.73 m²
 Perimeter: 3.48 m

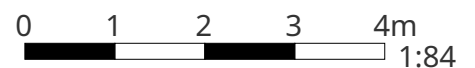
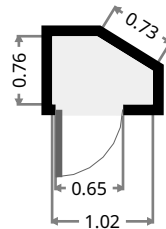
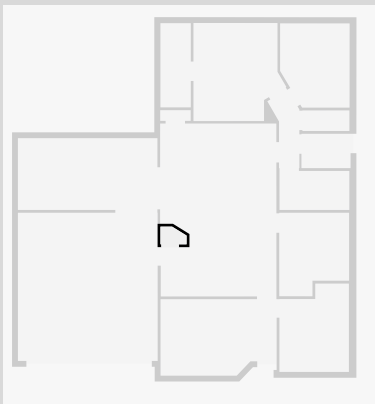

THIS FLOORPLAN IS PROVIDED WITHOUT WARRANTY OF ANY KIND. SENSOPIA DISCLAIMS ANY WARRANTY INCLUDING, WITHOUT LIMITATION, SATISFACTORY QUALITY OR ACCURACY OF DIMENSIONS.

10 Allen Road

Bedroom

Width: 2.99 m
 Length: 3.57 m
 Area: 9.63 m²
 Perimeter: 13.12 m

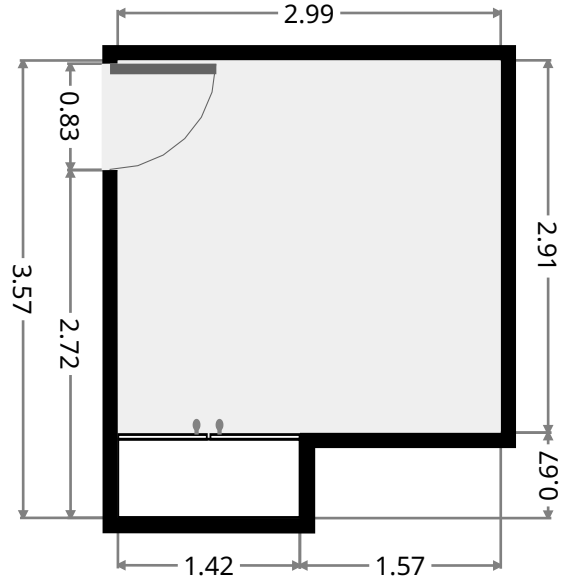
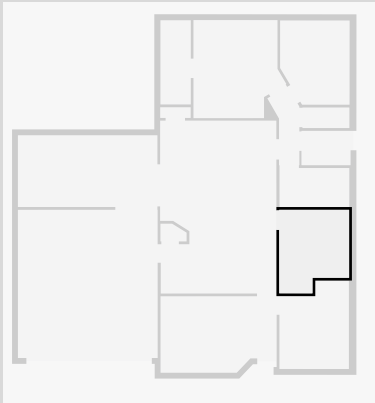

Hall

Width: 0.87 m
 Length: 2.51 m
 Area: 2.97 m²
 Perimeter: 8.38 m

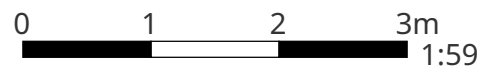
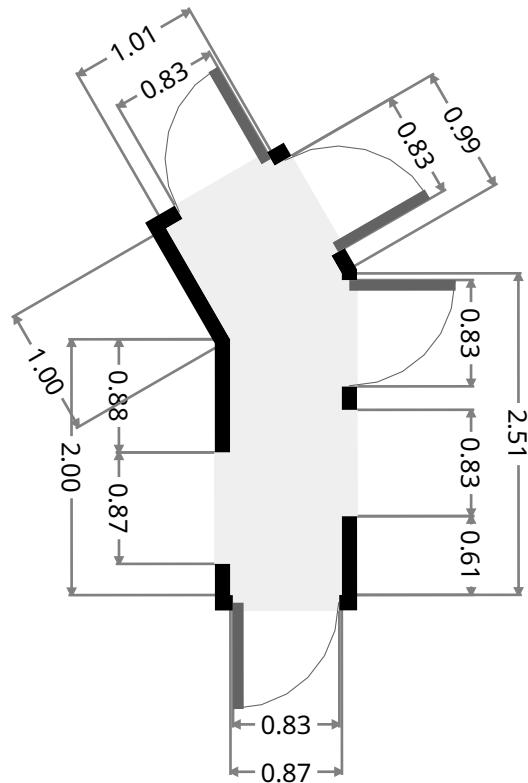
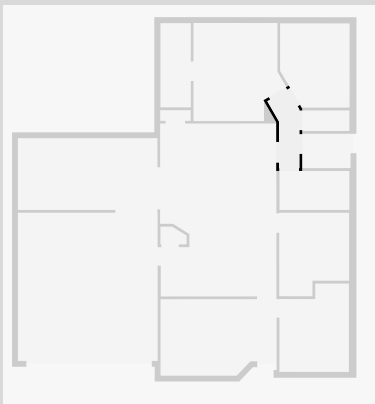

THIS FLOORPLAN IS PROVIDED WITHOUT WARRANTY OF ANY KIND. SENSOPIA DISCLAIMS ANY WARRANTY INCLUDING, WITHOUT LIMITATION, SATISFACTORY QUALITY OR ACCURACY OF DIMENSIONS.

10 Allen Road

Bathroom

Width: 1.67 m
 Length: 2.99 m
 Area: 4.99 m²
 Perimeter: 9.31 m

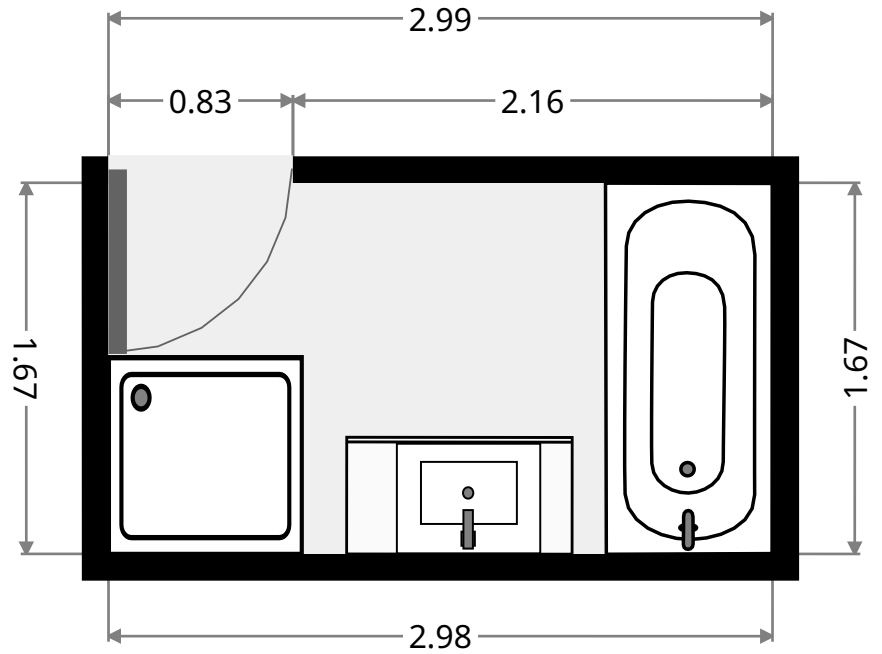
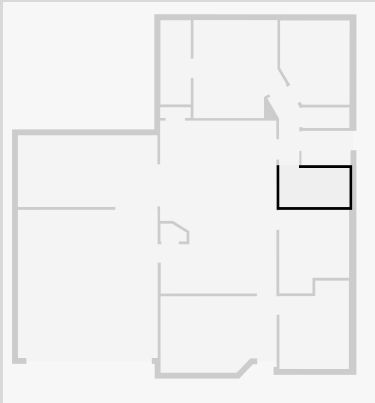

Laundry Room

Width: 1.47 m
 Length: 2.10 m
 Area: 3.09 m²
 Perimeter: 7.14 m

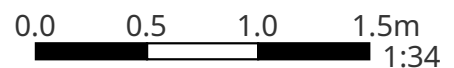
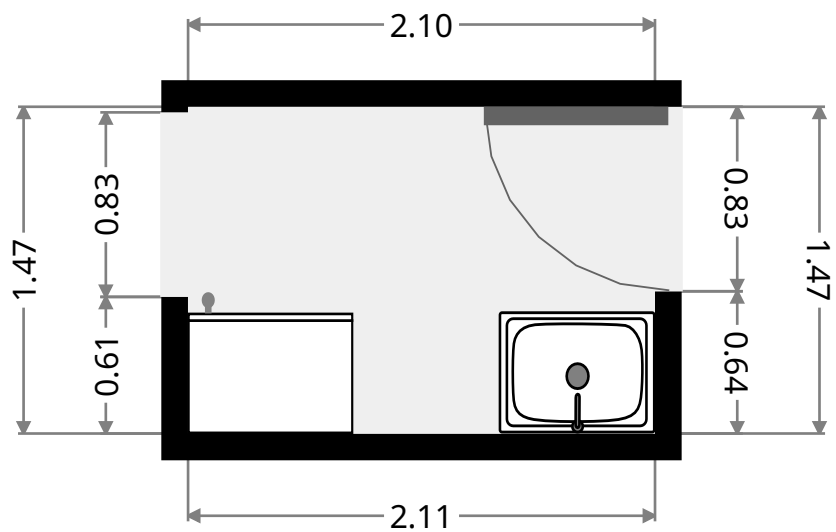
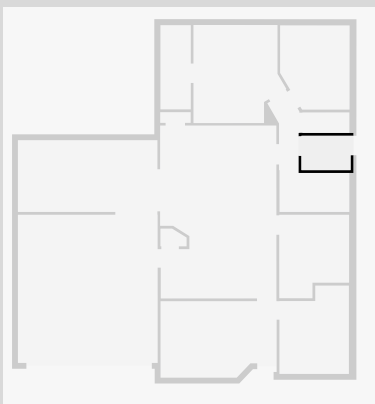

10 Allen Road

Toilet

Width: 0.88 m
Length: 2.01 m
Area: 1.77 m²
Perimeter: 5.78 m

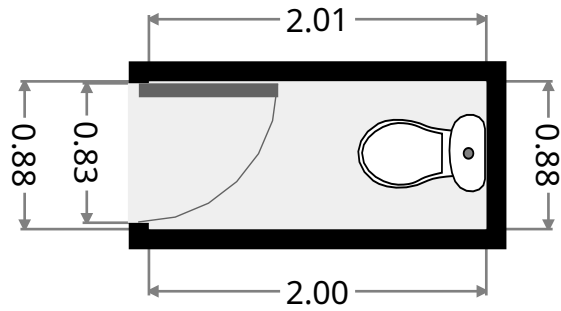
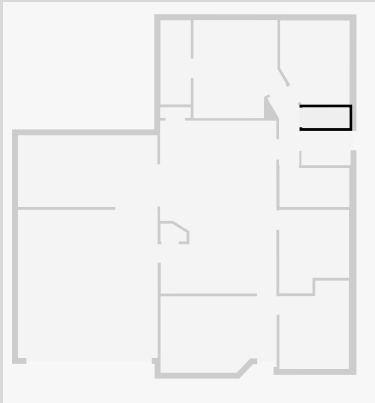

Bedroom

Width: 2.98 m
Length: 3.60 m
Area: 9.98 m²
Perimeter: 12.47 m

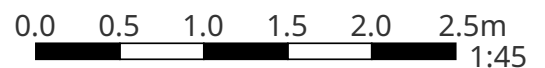
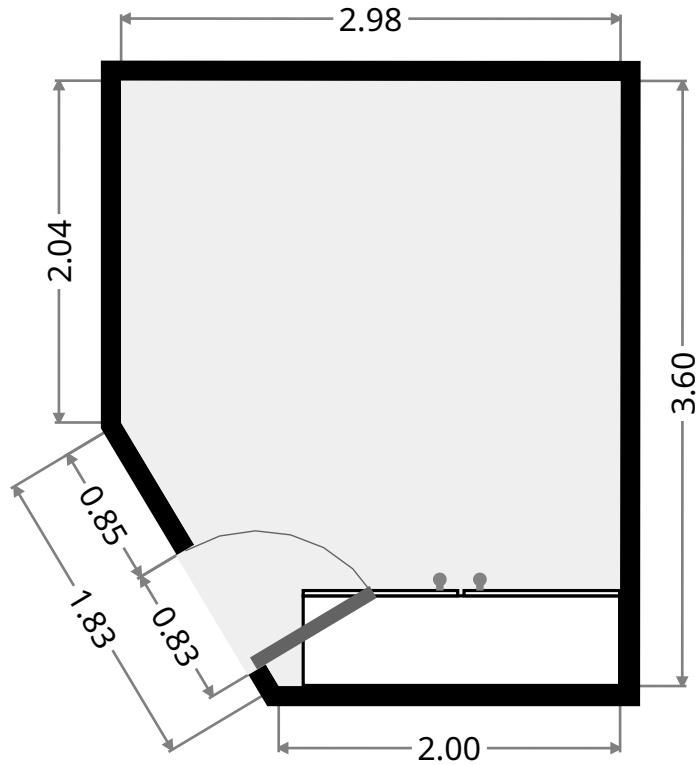
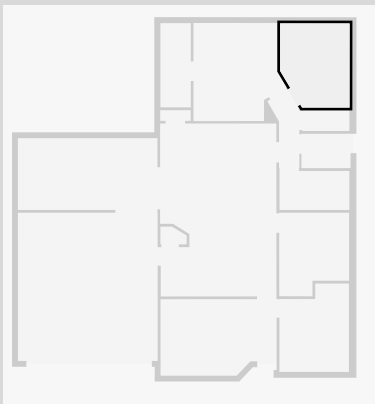

THIS FLOORPLAN IS PROVIDED WITHOUT WARRANTY OF ANY KIND. SENSOPIA DISCLAIMS ANY WARRANTY INCLUDING, WITHOUT LIMITATION, SATISFACTORY QUALITY OR ACCURACY OF DIMENSIONS.

10 Allen Road

Master Bedroom

Width: 3.60 m
 Length: 4.20 m
 Area: 14.64 m²
 Perimeter: 15.66 m

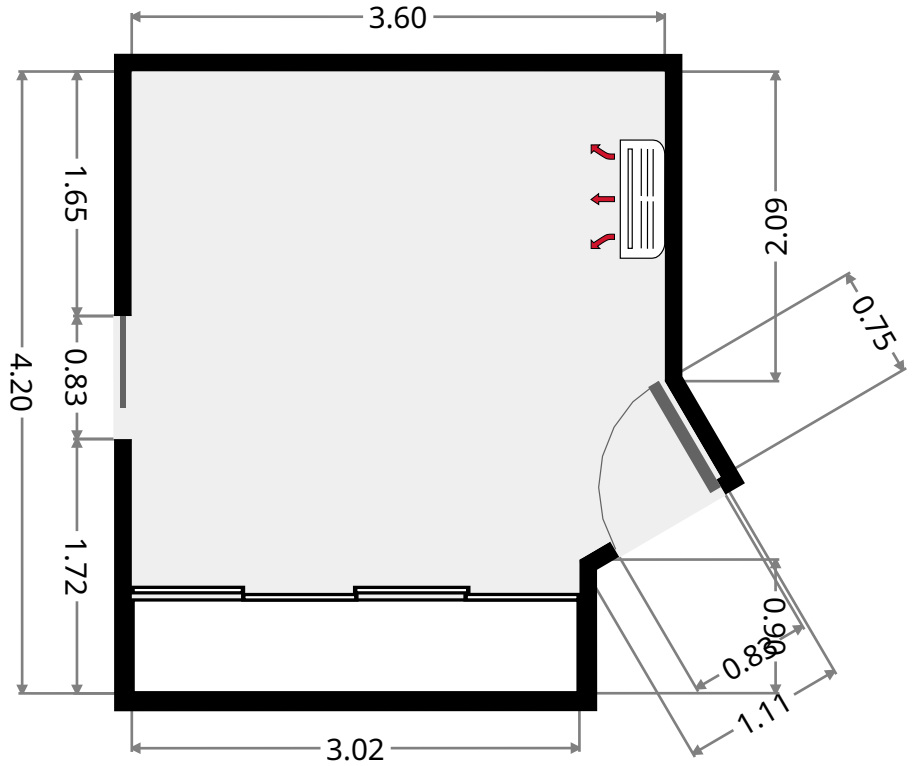
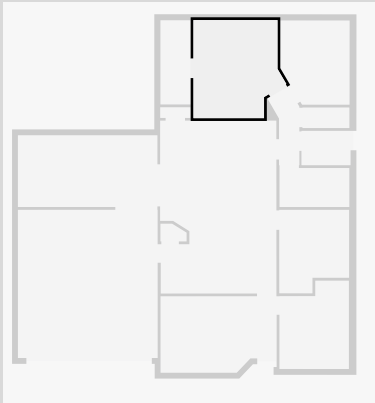

Bathroom

Width: 1.30 m
 Length: 3.60 m
 Area: 4.68 m²
 Perimeter: 9.80 m

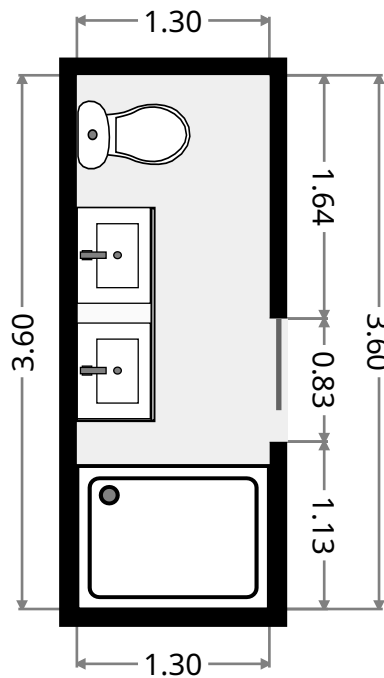
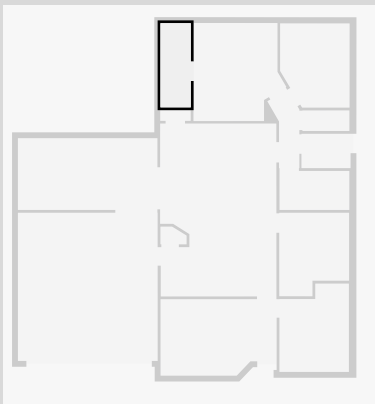

10 Allen Road

Closet

Width: 0.46 m
Length: 1.30 m
Area: 0.60 m²
Perimeter: 3.52 m

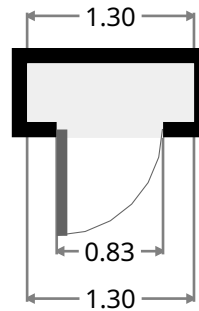
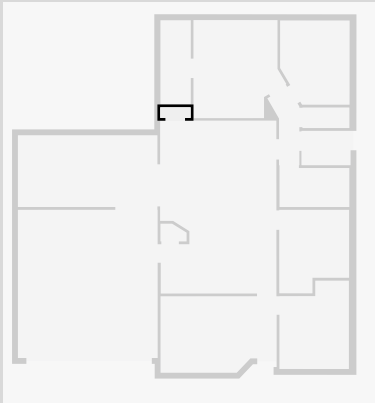

Outdoor Area

Width: 3.07 m
Length: 5.97 m
Area: 18.33 m²
Perimeter: 18.08 m

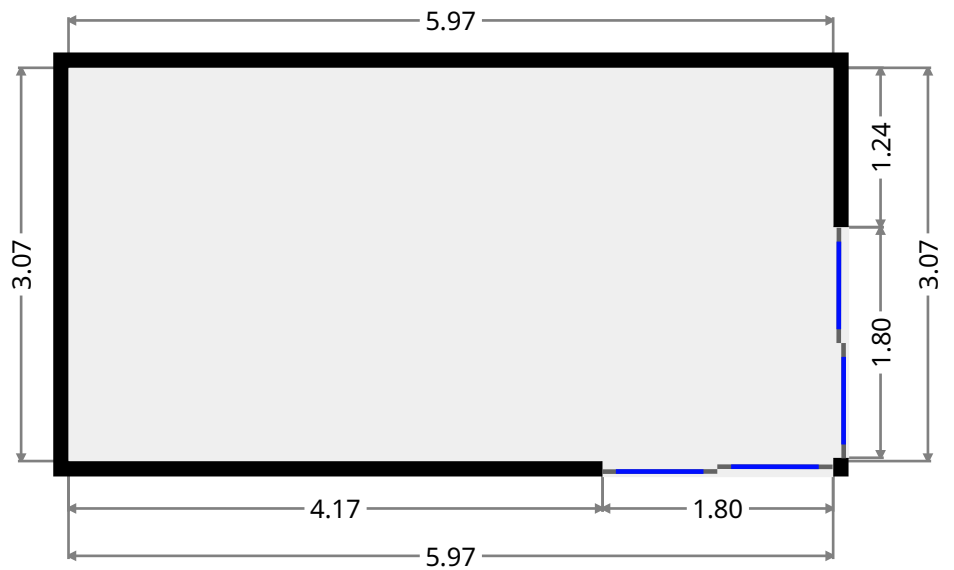
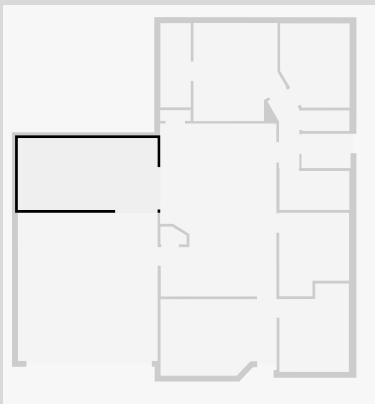

10 Allen Road

Garage

Width: 5.98 m
Length: 6.34 m
Area: 37.91 m²
Perimeter: 24.64 m

