

# 10/190 Lion Creek Road

Created on  
2021-05-13

Floors  
1

▼ Ground Floor



▼ **Hall**  
Ground Floor

WIDTH: 1.33 m • LENGTH: 8.85 m  
AREA: 9.25 m<sup>2</sup> • PERIMETER: 20.35 m

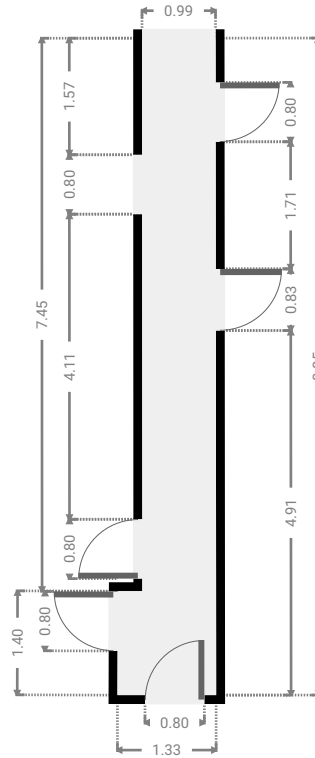
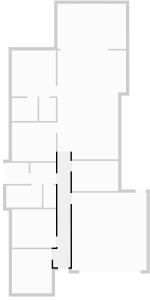

▼ **Bedroom**  
Ground Floor

WIDTH: 3.09 m • LENGTH: 3.42 m  
AREA: 10.57 m<sup>2</sup> • PERIMETER: 13.02 m

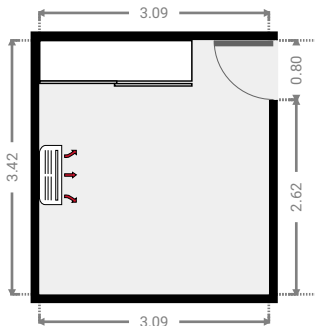
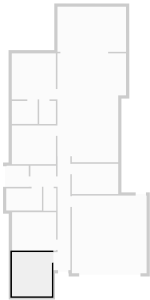

▼ **Bedroom**  
Ground Floor

WIDTH: 3.42 m • LENGTH: 2.98 m  
AREA: 10.19 m<sup>2</sup> • PERIMETER: 12.80 m

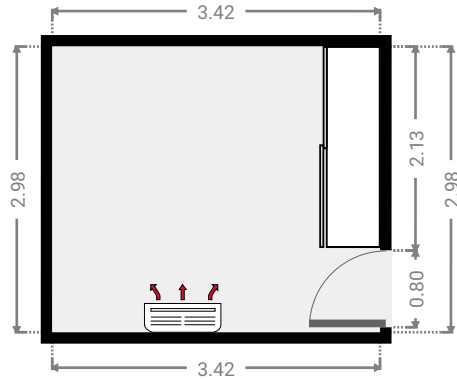
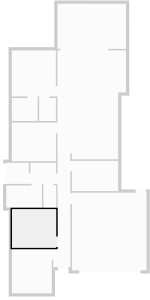

▼ **Garage**  
Ground Floor

WIDTH: 5.80 m • LENGTH: 6.03 m  
AREA: 34.97 m<sup>2</sup> • PERIMETER: 23.66 m

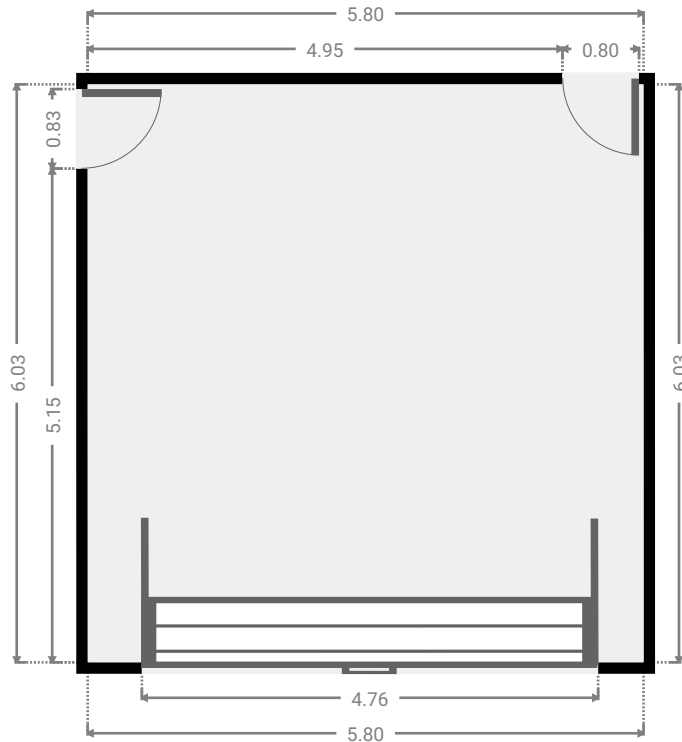
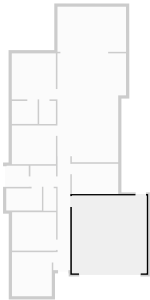

▼ **Toilet**  
Ground Floor

WIDTH: 1.00 m • LENGTH: 1.75 m  
AREA: 1.75 m<sup>2</sup> • PERIMETER: 5.50 m

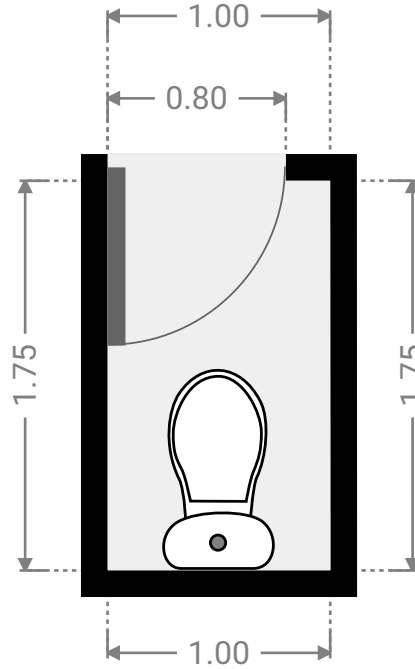
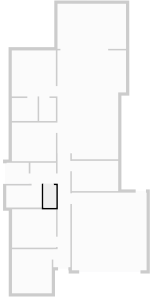

▼ **Bathroom**  
Ground Floor

WIDTH: 2.77 m • LENGTH: 1.71 m  
AREA: 4.74 m<sup>2</sup> • PERIMETER: 8.96 m

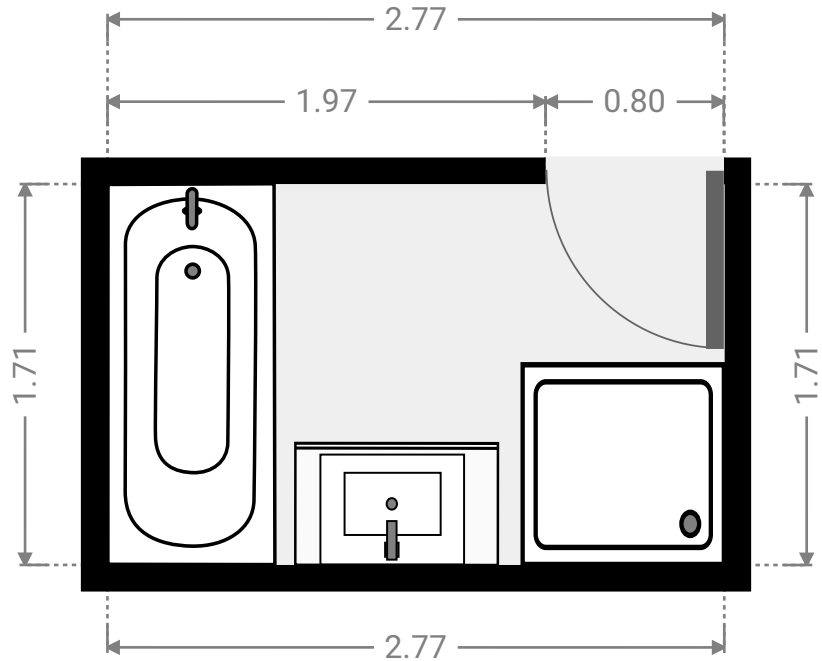
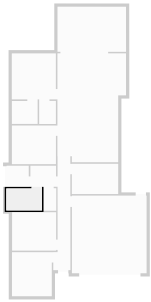

▼ **Laundry Room**  
Ground Floor

WIDTH: 1.72 m • LENGTH: 1.64 m  
AREA: 2.82 m<sup>2</sup> • PERIMETER: 6.72 m

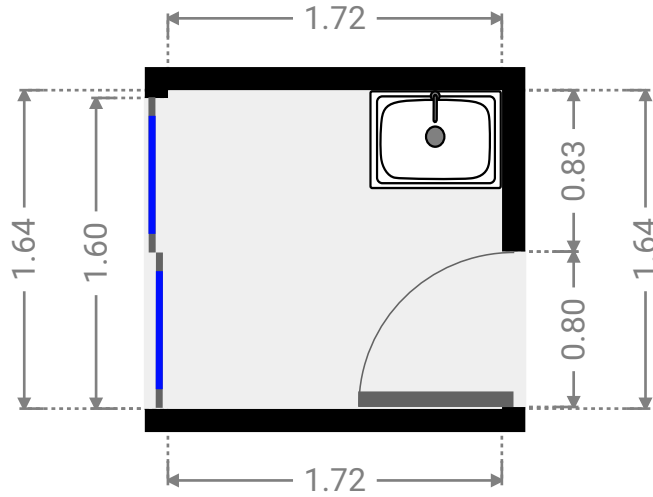
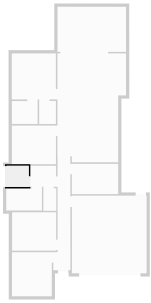

▼ **Hall**  
Ground Floor

WIDTH: 1.99 m • LENGTH: 1.63 m  
AREA: 3.25 m<sup>2</sup> • PERIMETER: 7.25 m

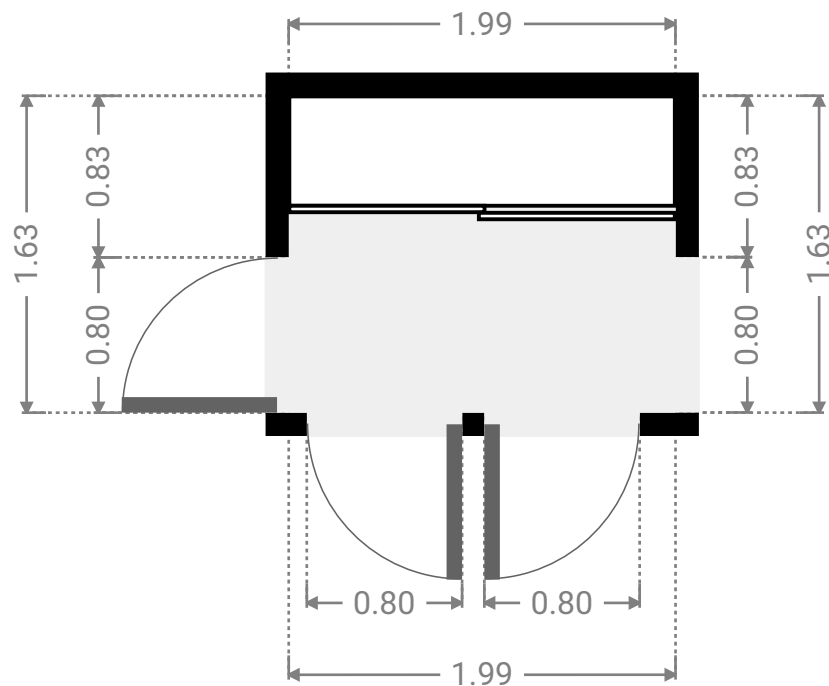
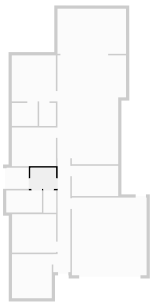

▼ **Bedroom**  
Ground Floor

WIDTH: 3.60 m • LENGTH: 2.35 m  
AREA: 8.46 m<sup>2</sup> • PERIMETER: 11.90 m

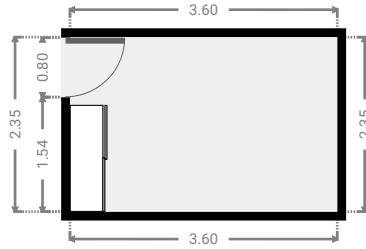
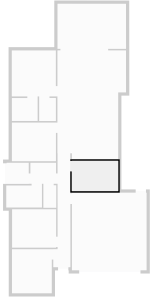

▼ **Kitchen**  
Ground Floor

WIDTH: 5.33 m • LENGTH: 8.46 m  
AREA: 41.22 m<sup>2</sup> • PERIMETER: 27.56 m

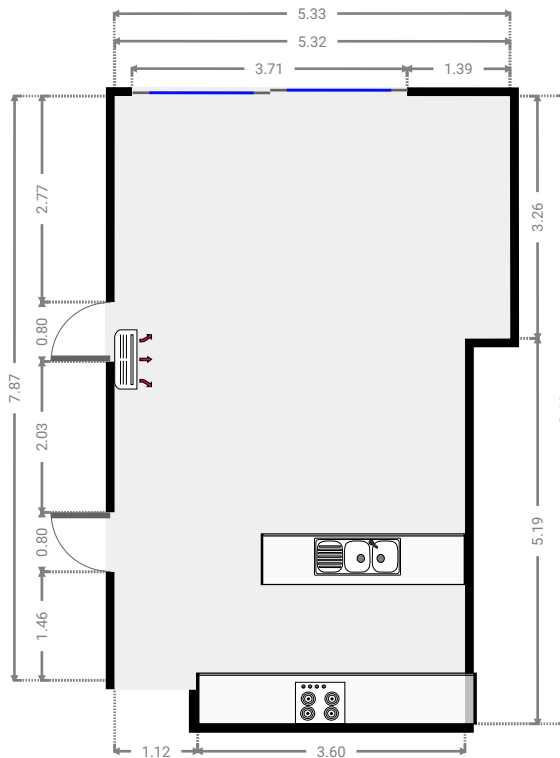
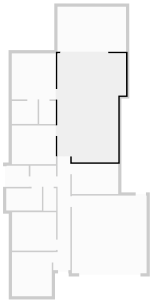

▼ **Bedroom**  
Ground Floor

WIDTH: 3.42 m • LENGTH: 3.00 m  
AREA: 10.26 m<sup>2</sup> • PERIMETER: 12.84 m

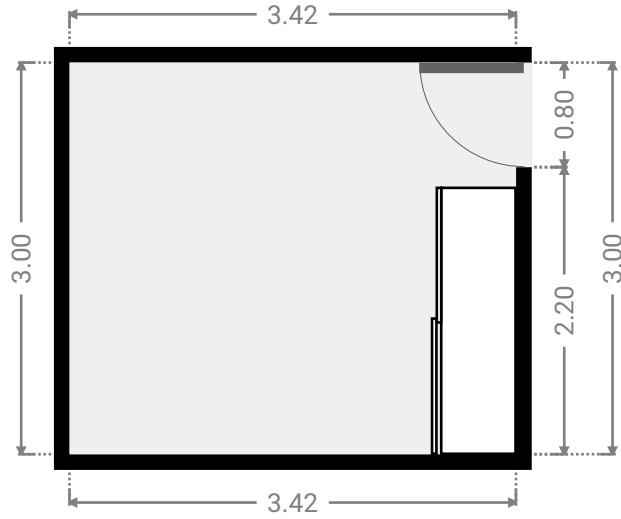
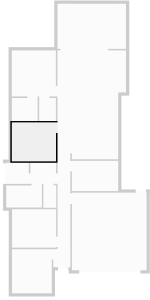

▼ **Master Bedroom**  
Ground Floor

WIDTH: 3.42 m • LENGTH: 3.57 m  
AREA: 12.21 m<sup>2</sup> • PERIMETER: 13.98 m

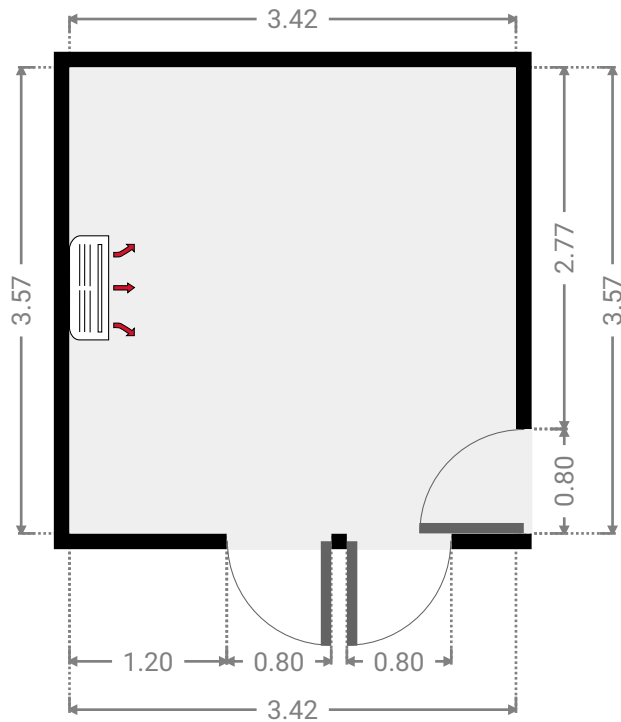
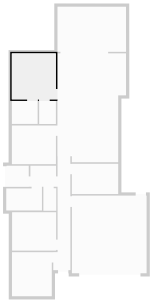



▼ Bathroom  
Ground Floor

WIDTH: 2.00 m • LENGTH: 1.78 m  
AREA: 3.56 m<sup>2</sup> • PERIMETER: 7.56 m

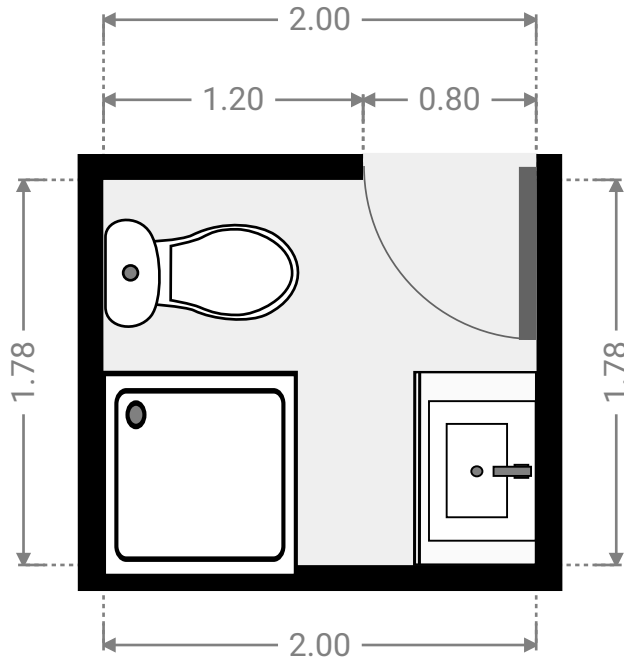
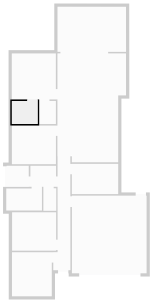

▼ Closet  
Ground Floor

WIDTH: 1.30 m • LENGTH: 1.79 m  
AREA: 2.33 m<sup>2</sup> • PERIMETER: 6.18 m

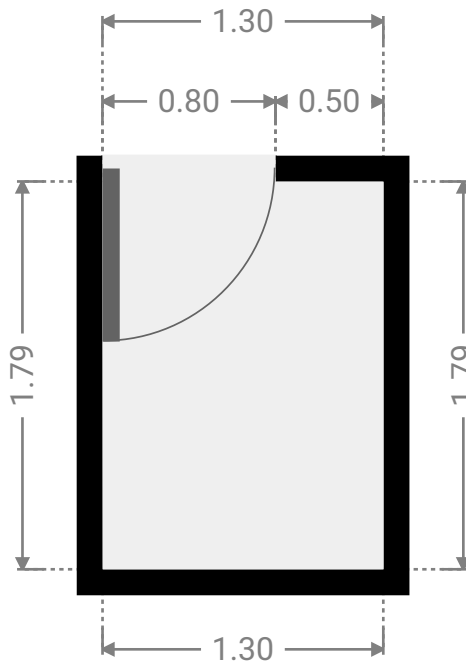
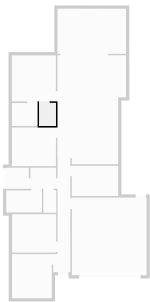

▼ Other  
Ground Floor

WIDTH: 5.32 m • LENGTH: 3.51 m  
AREA: 18.63 m<sup>2</sup> • PERIMETER: 17.64 m

