

1 Riley Drive

Created on
2020-08-04

Floors
1

▼ Ground Floor

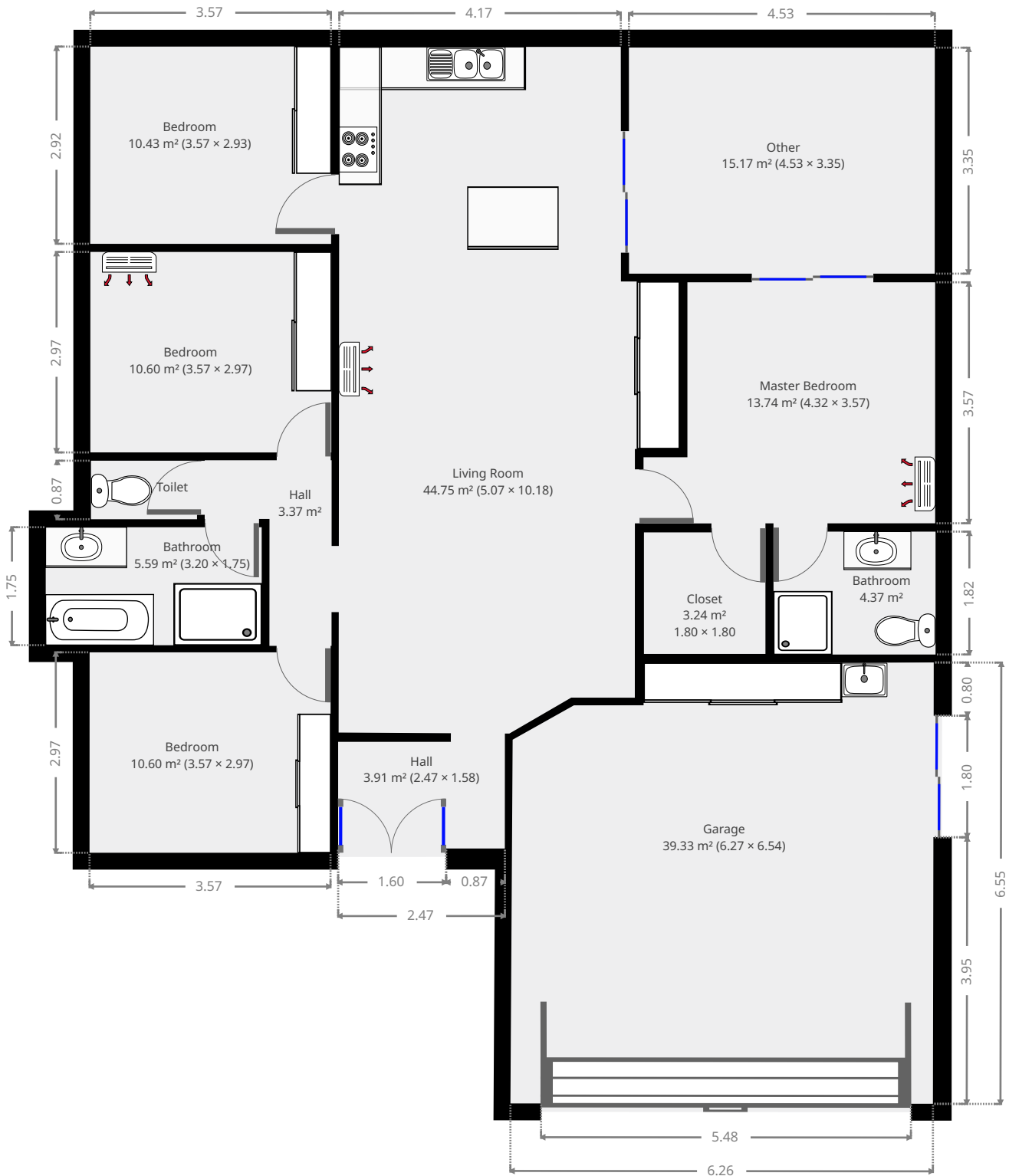

THIS FLOORPLAN IS PROVIDED WITHOUT WARRANTY OF ANY KIND. SENSOPIA DISCLAIMS ANY WARRANTY INCLUDING, WITHOUT LIMITATION, SATISFACTORY QUALITY OR ACCURACY OF DIMENSIONS.

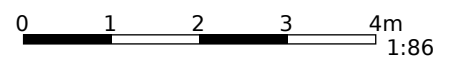

▼ Hall Ground Floor

WIDTH: 2.47 m • LENGTH: 1.58 m
AREA: 3.91 m² • PERIMETER: 8.10 m

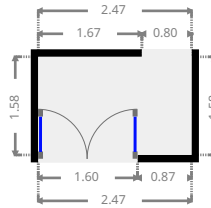
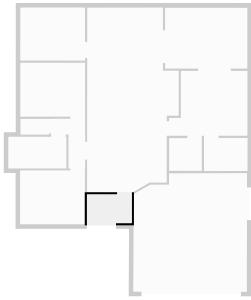

▼ Living Room Ground Floor

WIDTH: 5.07 m • LENGTH: 10.18 m
AREA: 44.75 m² • PERIMETER: 30.03 m

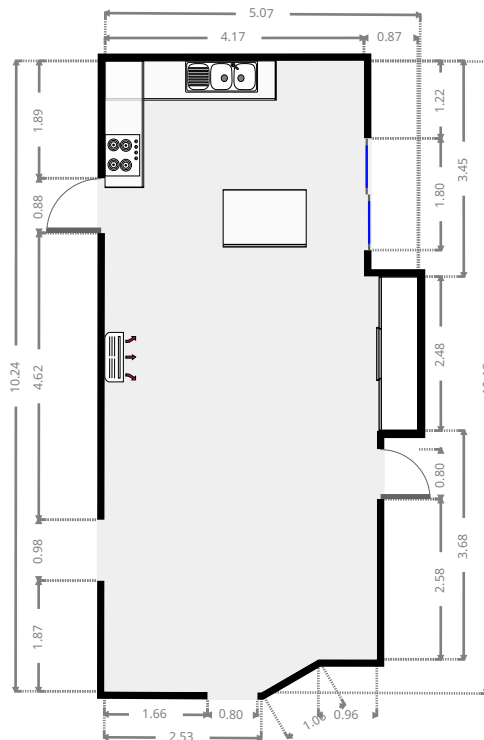
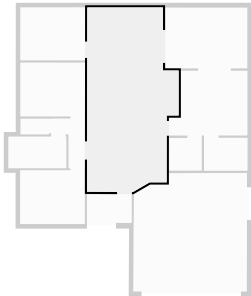

FLOORS: 1

▼ Garage Ground Floor

WIDTH: 6.27 m • LENGTH: 6.54 m
AREA: 39.33 m² • PERIMETER: 25.18 m

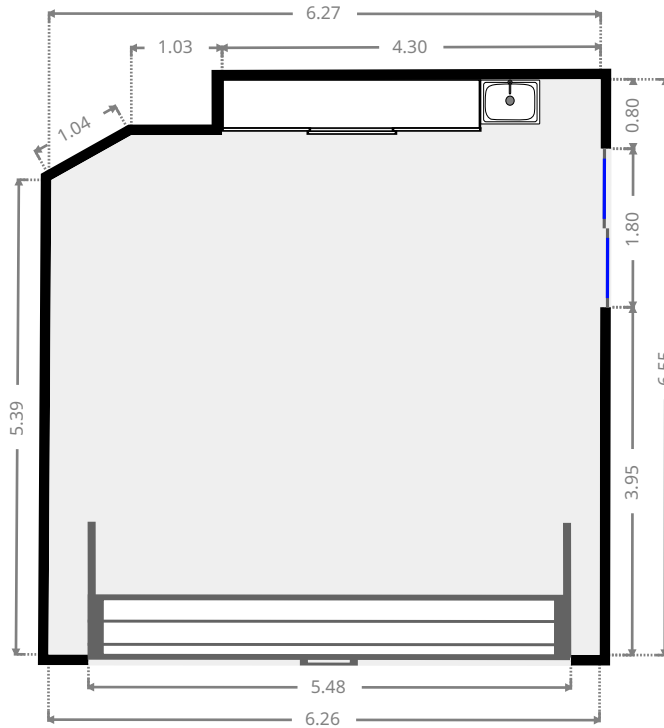
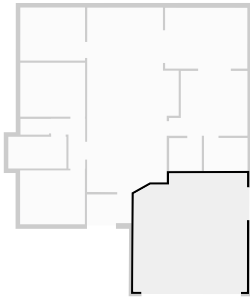

▼ Closet Ground Floor

WIDTH: 1.80 m • LENGTH: 1.80 m
AREA: 3.24 m² • PERIMETER: 7.20 m

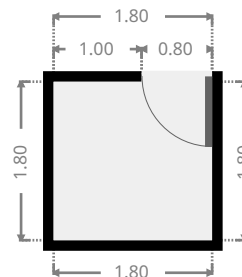
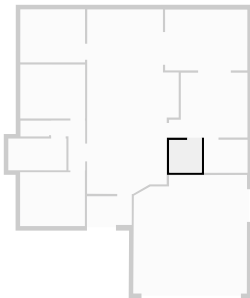

▼ Bathroom Ground Floor

WIDTH: 2.40 m • LENGTH: 1.82 m
AREA: 4.37 m² • PERIMETER: 8.44 m

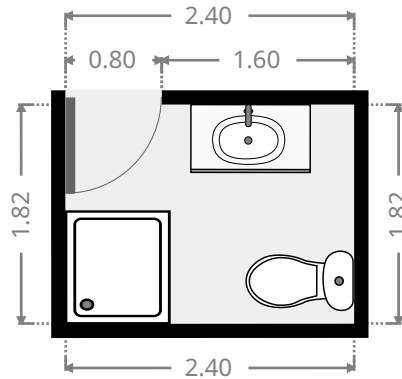
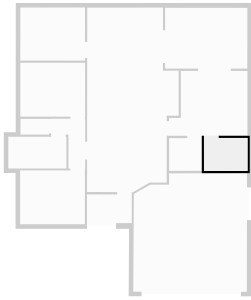

▼ Master Bedroom Ground Floor

WIDTH: 4.32 m • LENGTH: 3.57 m
AREA: 13.74 m² • PERIMETER: 15.78 m

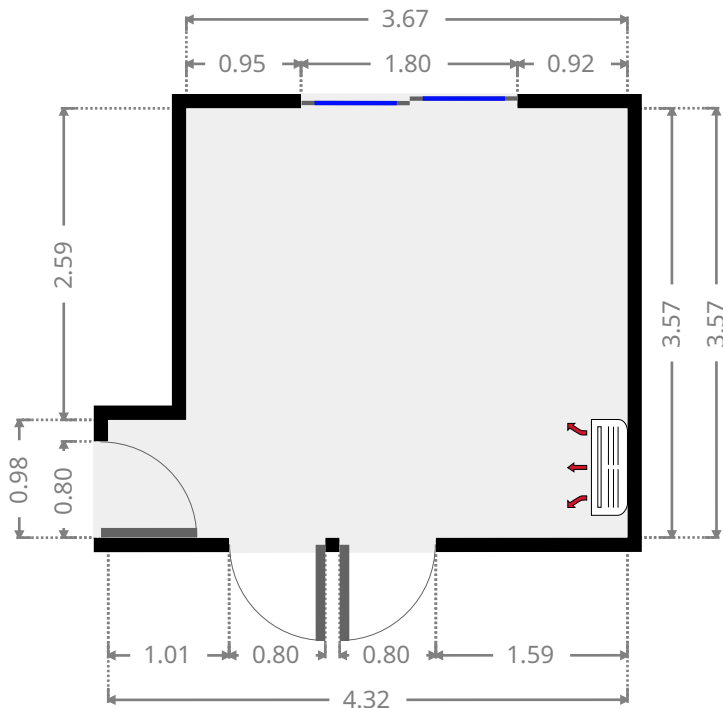
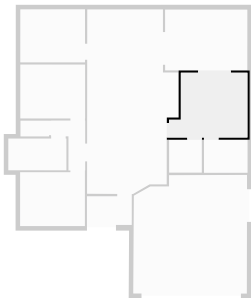

▼ Other Ground Floor

WIDTH: 4.53 m • LENGTH: 3.35 m
AREA: 15.17 m² • PERIMETER: 15.76 m

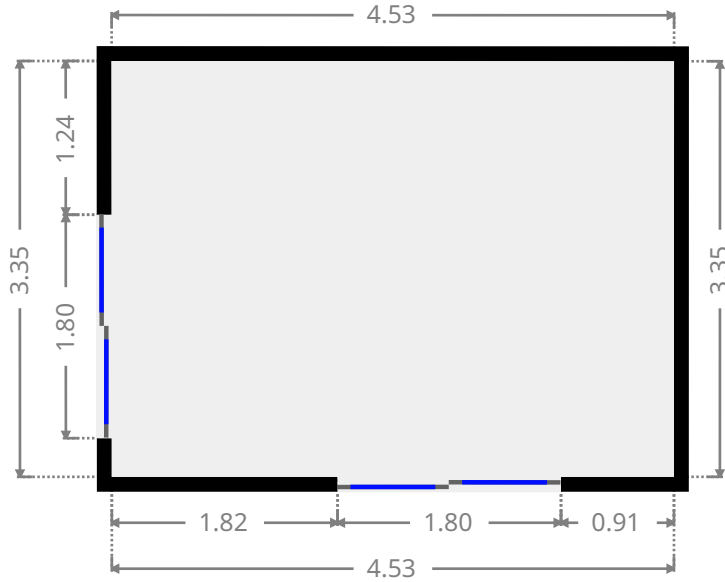
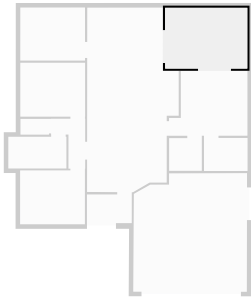

▼ Hall Ground Floor

WIDTH: 1.88 m • LENGTH: 2.75 m
AREA: 3.37 m² • PERIMETER: 9.26 m

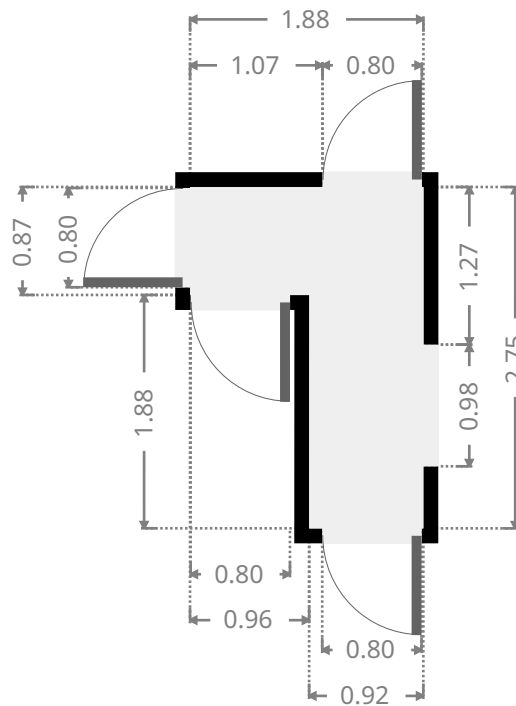
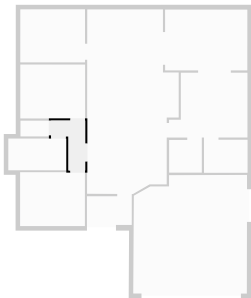

▼ Bedroom Ground Floor

WIDTH: 3.57 m • LENGTH: 2.97 m
AREA: 10.60 m² • PERIMETER: 13.08 m

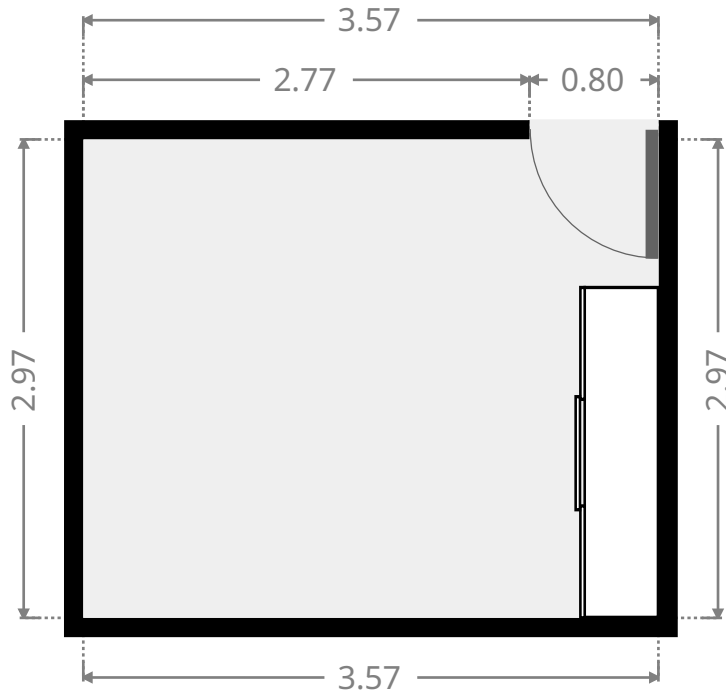
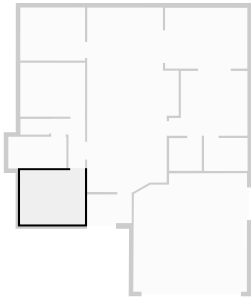

▼ Bathroom Ground Floor

WIDTH: 3.20 m • LENGTH: 1.75 m
AREA: 5.59 m² • PERIMETER: 9.89 m

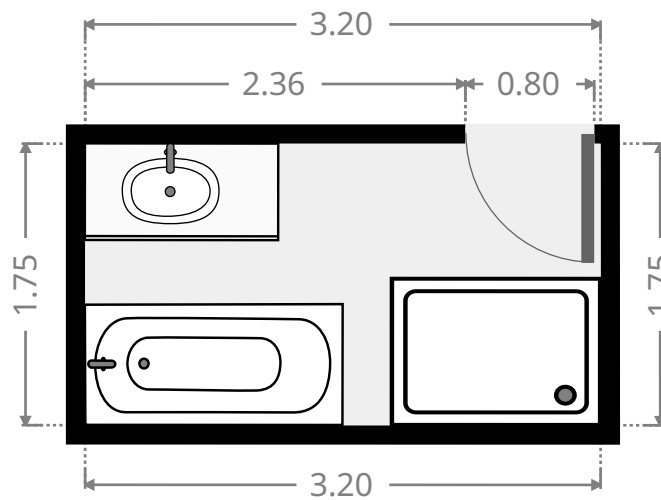
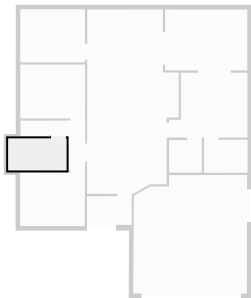

▼ Toilet Ground Floor

WIDTH: 1.57 m • LENGTH: 0.87 m
AREA: 1.36 m² • PERIMETER: 4.88 m

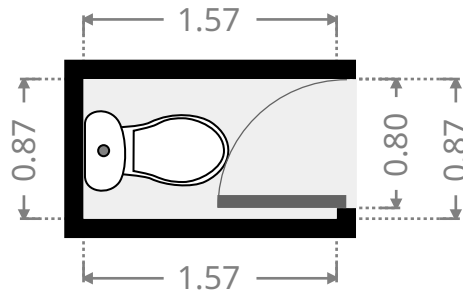
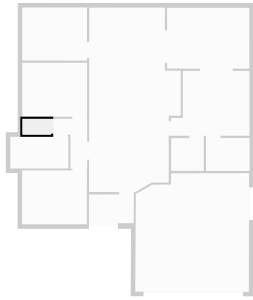

▼ Bedroom Ground Floor

WIDTH: 3.57 m • LENGTH: 2.97 m
AREA: 10.60 m² • PERIMETER: 13.08 m

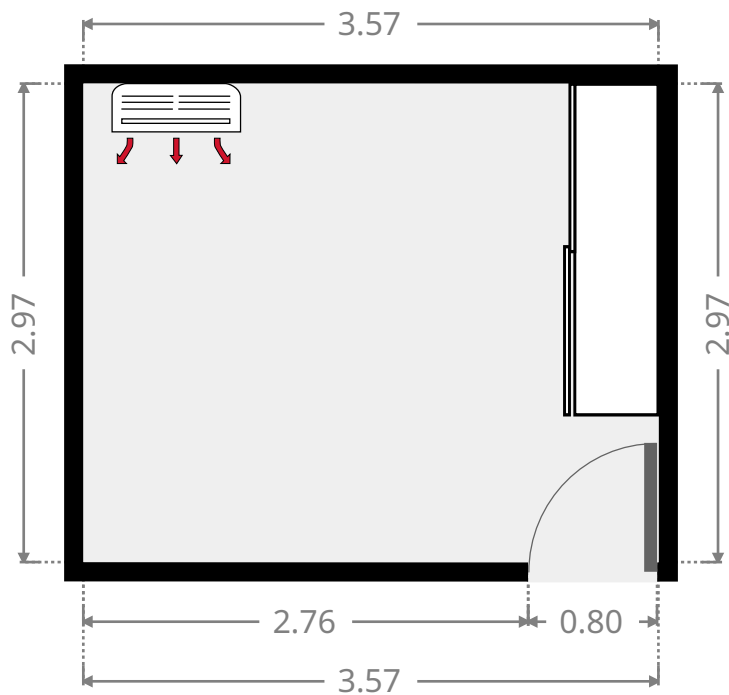
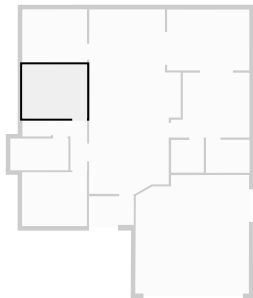

▼ Bedroom Ground Floor

WIDTH: 3.57 m • LENGTH: 2.93 m
AREA: 10.43 m² • PERIMETER: 12.98 m

