

1 Medcraf Street

SUBMITTED BY

Ray White Rockhampton Casey
stockers@cqoz.com

CREATED ON

2018-04-03

Floors

1

▼ Ground Floor

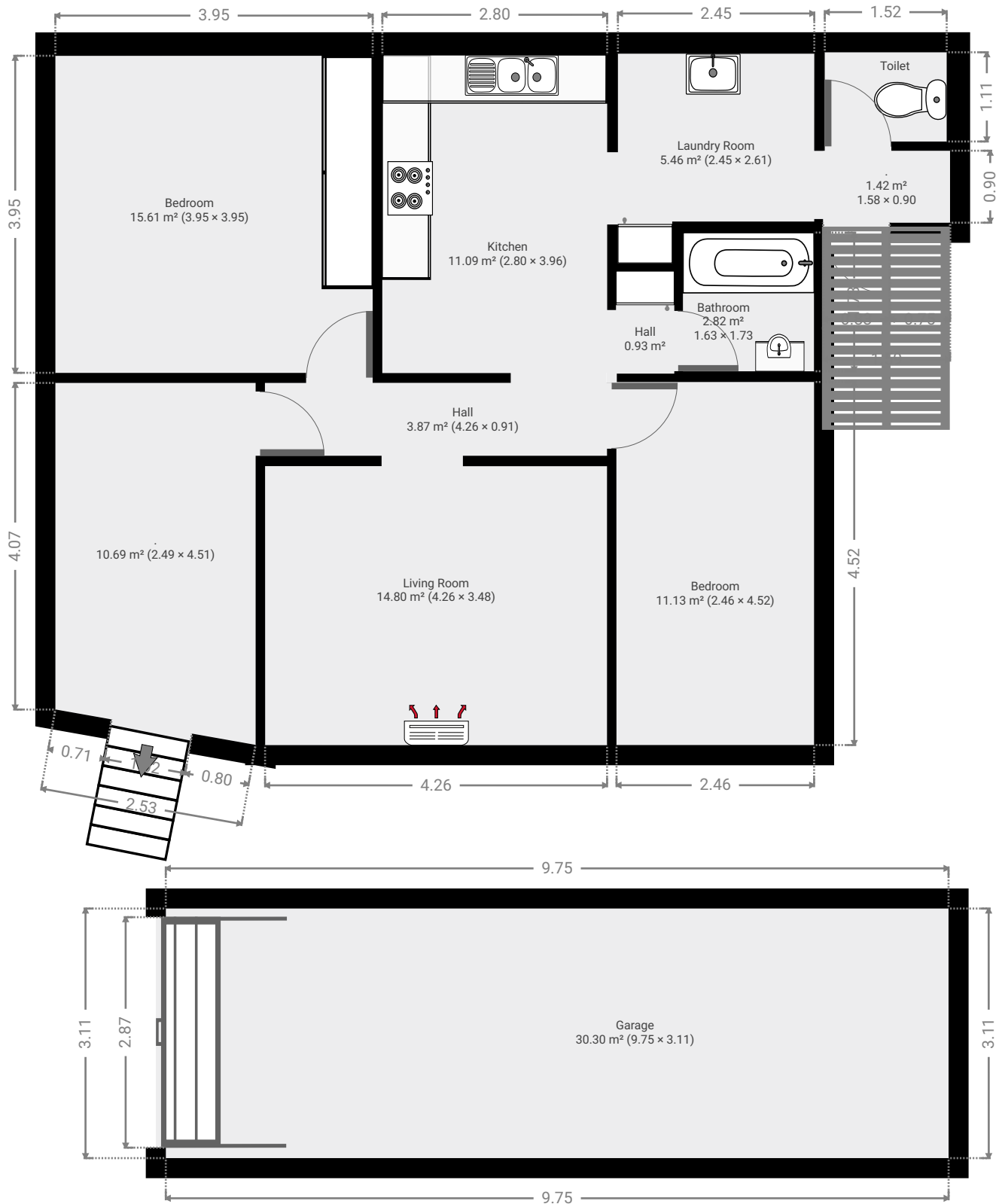

▼ **Hall**
Ground Floor

WIDTH: 0.91 m • LENGTH: 4.26 m
AREA: 3.87 m² • PERIMETER: 10.34 m

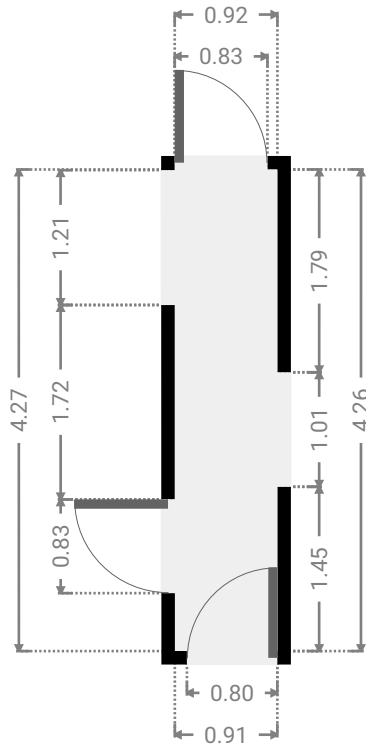
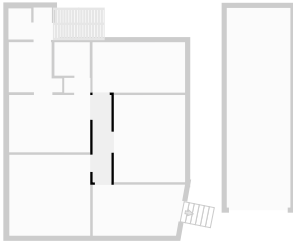

▼ **Bedroom**
Ground Floor

WIDTH: 3.95 m • LENGTH: 3.95 m
AREA: 15.61 m² • PERIMETER: 15.80 m

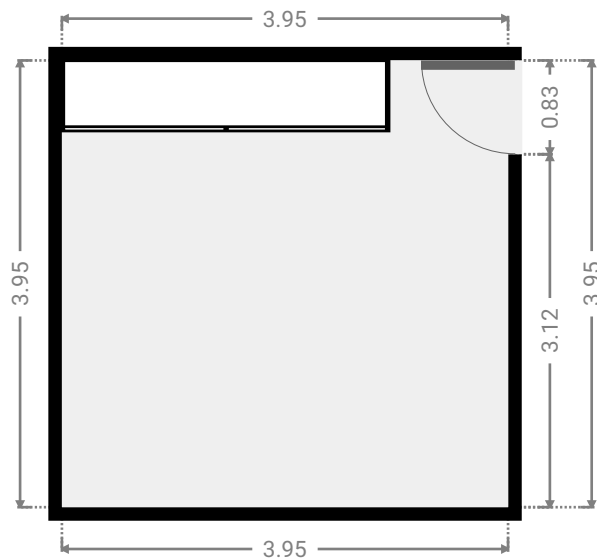
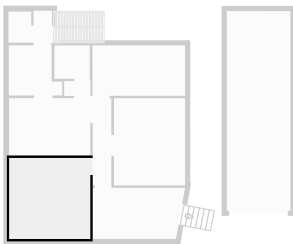

FLOORS: 1

▼ **Living Room**
Ground Floor

WIDTH: 3.48 m • LENGTH: 4.26 m
AREA: 14.80 m² • PERIMETER: 15.47 m

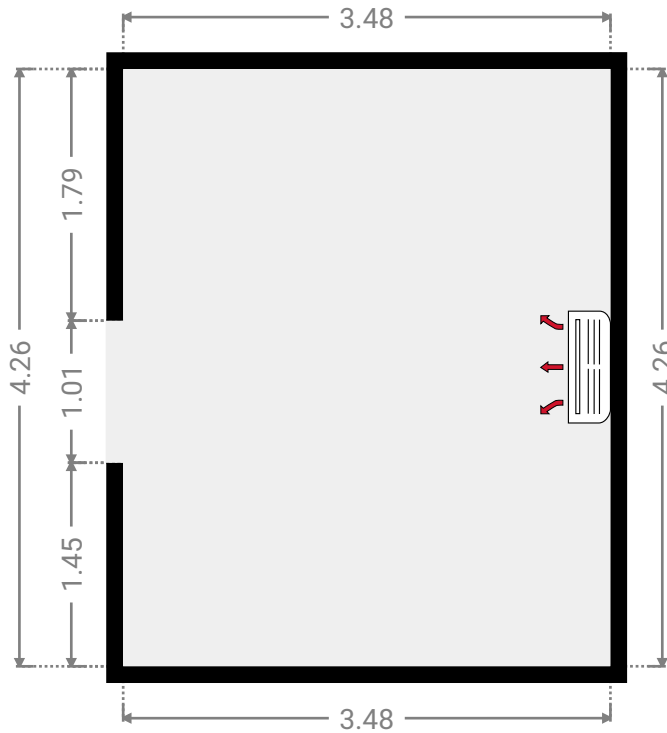
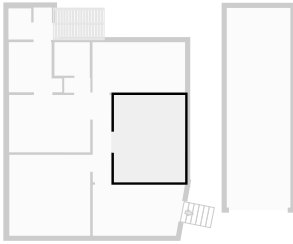

▼ **Kitchen**
Ground Floor

WIDTH: 3.96 m • LENGTH: 2.80 m
AREA: 11.09 m² • PERIMETER: 13.52 m

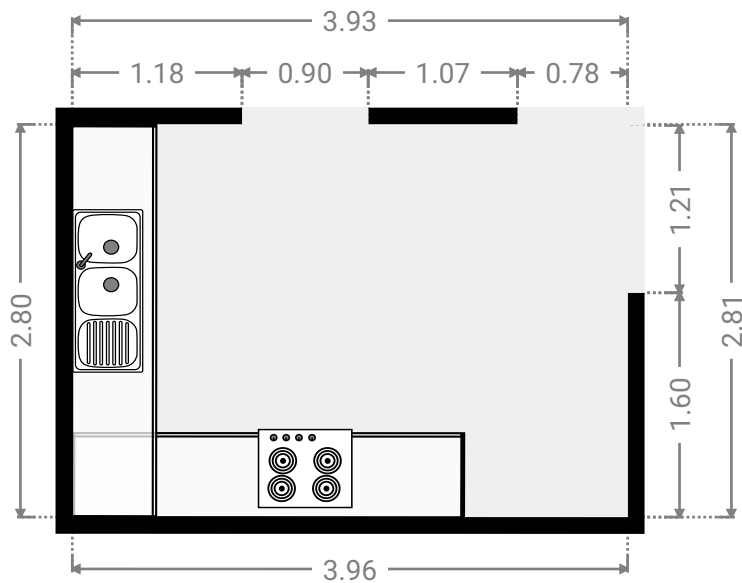
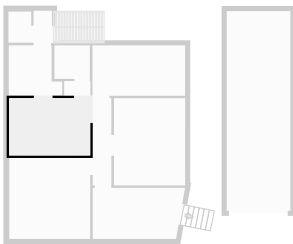

▼ **Hall**
Ground Floor

WIDTH: 1.28 m • LENGTH: 0.73 m
AREA: 0.93 m² • PERIMETER: 4.01 m

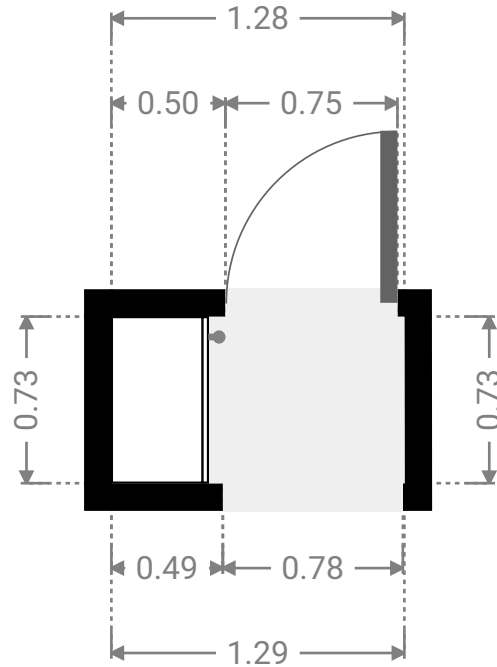
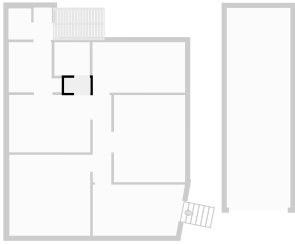

▼ **Bathroom**
Ground Floor

WIDTH: 1.73 m • LENGTH: 1.63 m
AREA: 2.82 m² • PERIMETER: 6.72 m

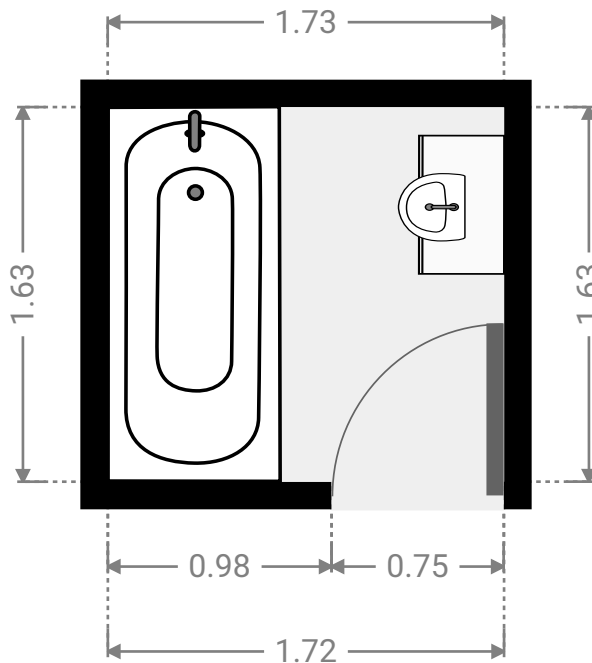
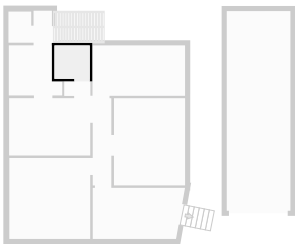

▼ Laundry Room
Ground Floor

WIDTH: 2.61 m • LENGTH: 2.45 m
AREA: 5.46 m² • PERIMETER: 10.11 m

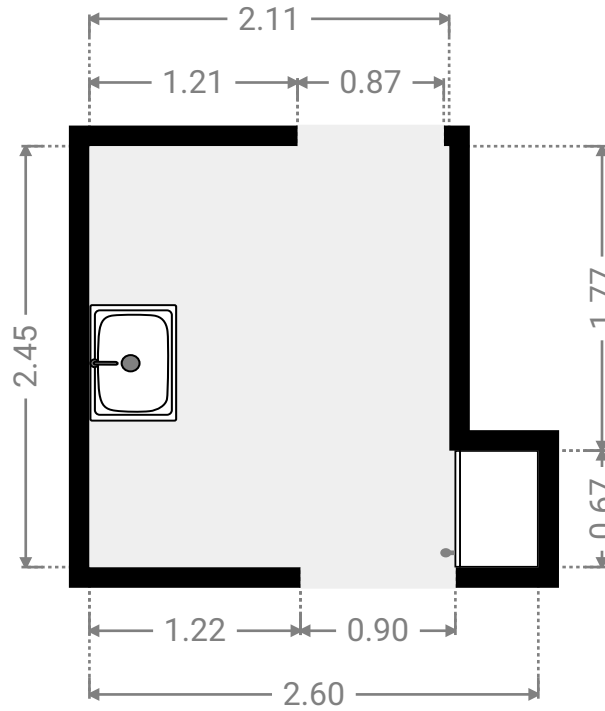
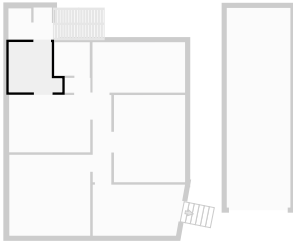

▼ .
Ground Floor

WIDTH: 0.90 m • LENGTH: 1.59 m
AREA: 1.42 m² • PERIMETER: 4.96 m

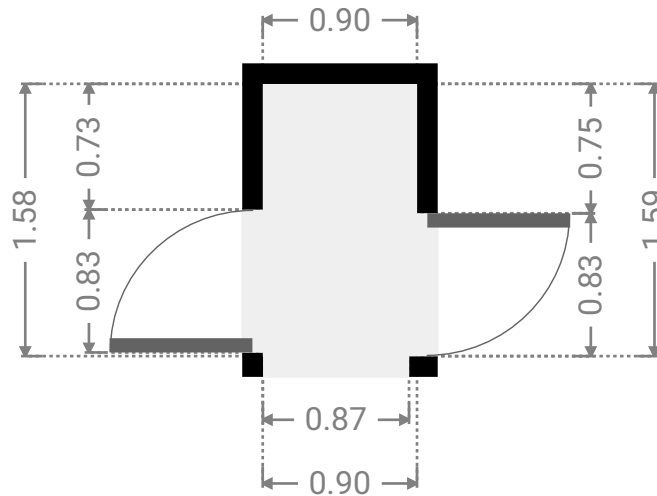
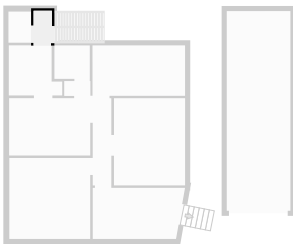

▼ Toilet
Ground Floor

WIDTH: 1.11 m • LENGTH: 1.51 m
AREA: 1.69 m² • PERIMETER: 5.26 m

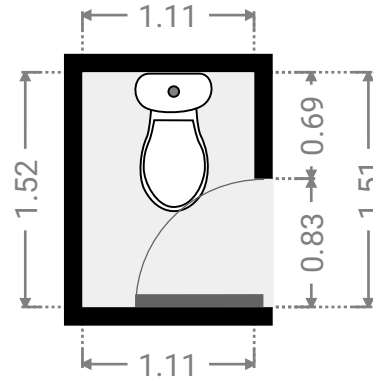
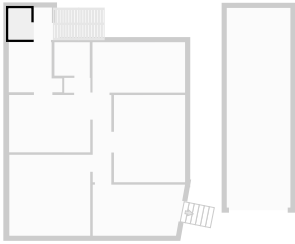

▼ .
Ground Floor

WIDTH: 4.51 m • LENGTH: 2.49 m
AREA: 10.69 m² • PERIMETER: 13.60 m

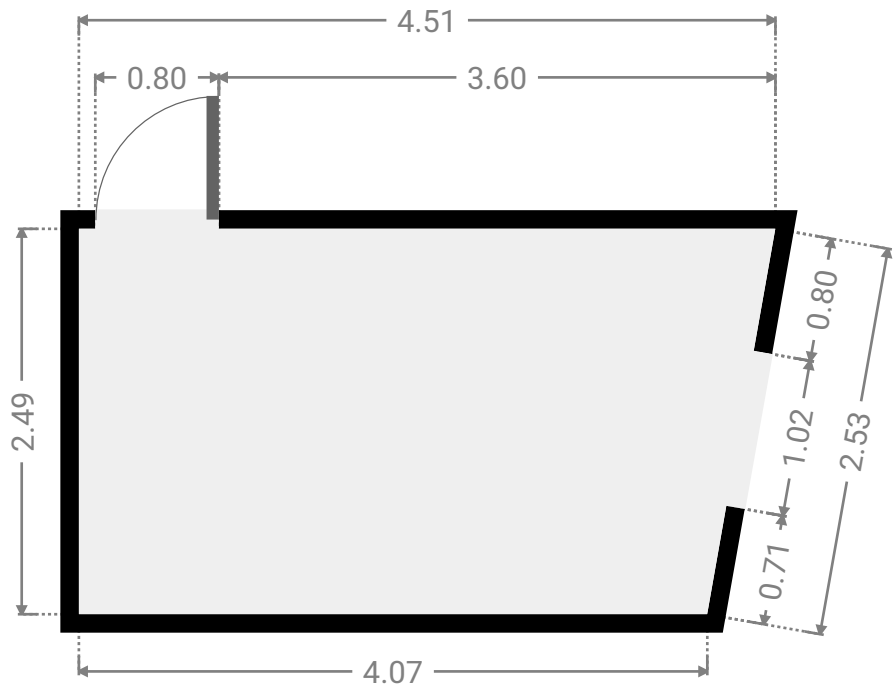
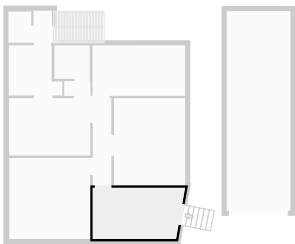

▼ Garage Ground Floor

WIDTH: 3.11 m • LENGTH: 9.75 m
AREA: 30.30 m² • PERIMETER: 25.72 m

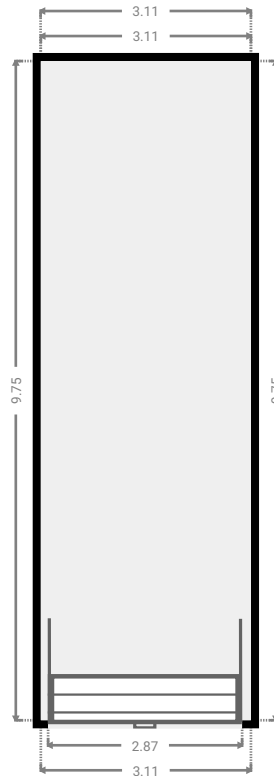
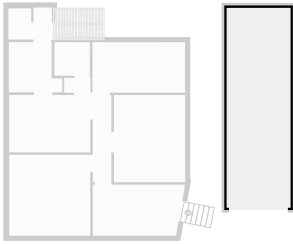

▼ Bedroom Ground Floor

WIDTH: 4.52 m • LENGTH: 2.46 m
AREA: 11.13 m² • PERIMETER: 13.97 m

