

1 Magnolia Court

SUBMITTED BY

Ray White Rockhampton Casey
stockers@cqoz.com

CREATED ON

2022-04-22

Floors

1

1 Magnolia Court

FLOORS: 1

▼ Ground Floor



THIS FLOORPLAN IS PROVIDED WITHOUT WARRANTY OF ANY KIND. SENSOPIA DISCLAIMS ANY WARRANTY INCLUDING, WITHOUT LIMITATION, SATISFACTORY QUALITY OR ACCURACY OF DIMENSIONS.



1 Magnolia Court

FLOORS: 1



▼ Living Room Ground Floor

WIDTH: 6.14 m • LENGTH: 6.45 m
AREA: 33.01 m² • PERIMETER: 23.50 m

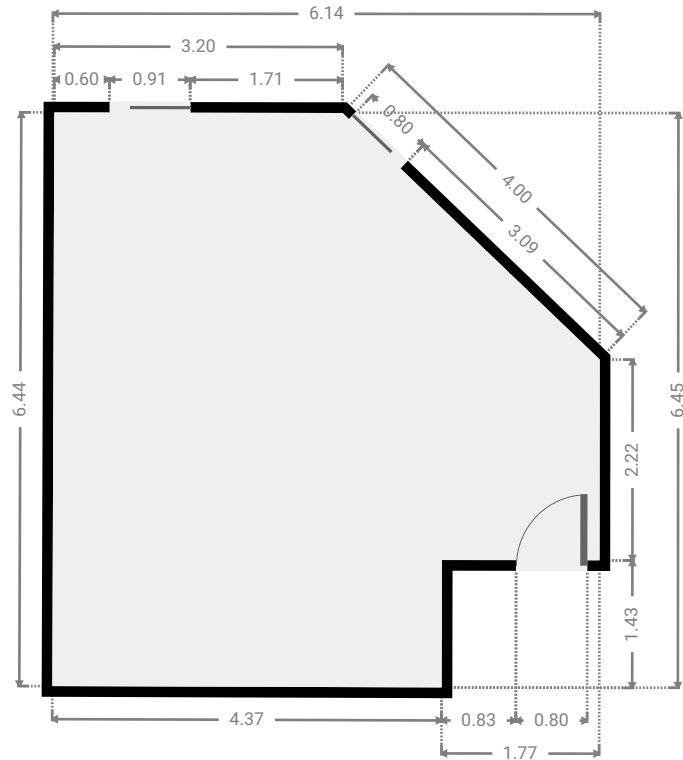
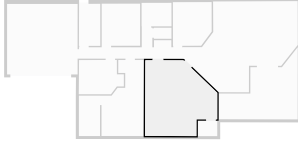

▼ Hall Ground Floor

WIDTH: 8.85 m • LENGTH: 1.57 m
AREA: 9.44 m² • PERIMETER: 20.84 m

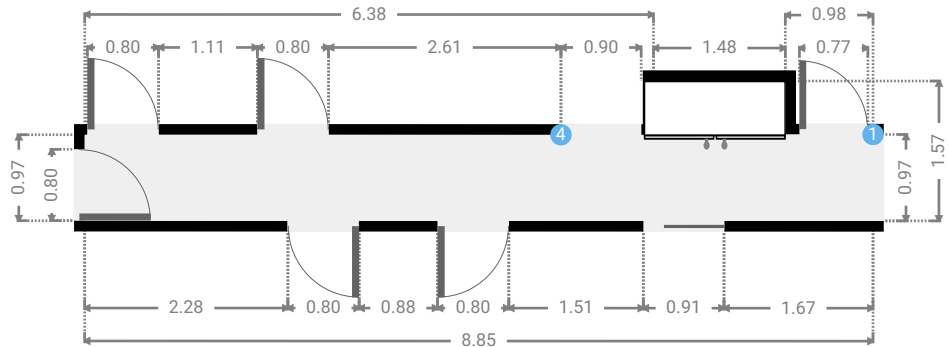
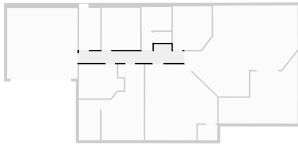

▼ Hall/Ground Floor

1 OPENING

Height
0.00 m



▼ Kitchen Ground Floor

WIDTH: 9.66 m • LENGTH: 7.77 m
AREA: 51.08 m² • PERIMETER: 31.58 m

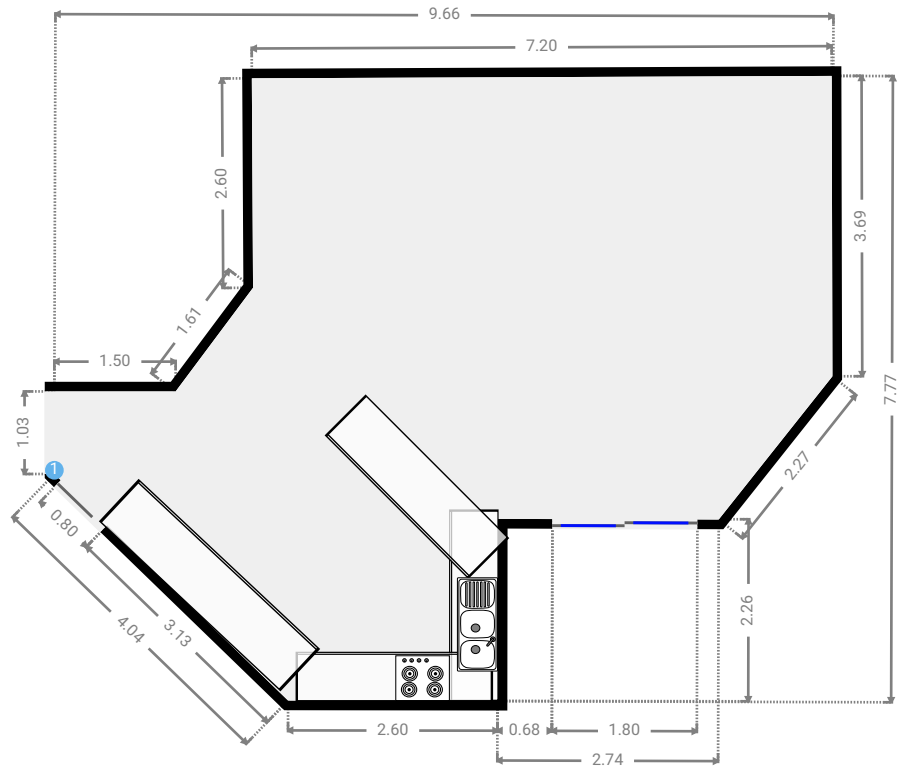
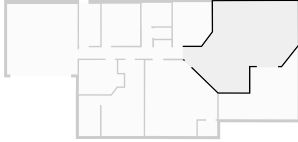

▼ Bedroom Ground Floor

WIDTH: 3.31 m • LENGTH: 3.72 m
AREA: 11.71 m² • PERIMETER: 13.43 m

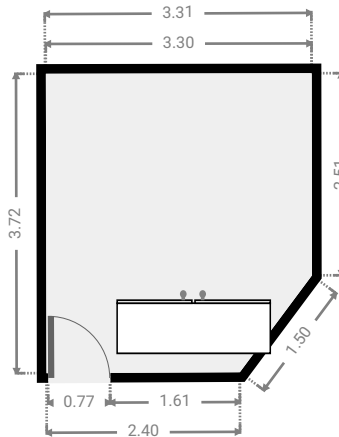
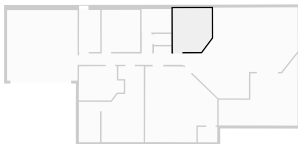

1 Magnolia Court

FLOORS: 1

▼ Hall Ground Floor

WIDTH: 0.90 m • LENGTH: 1.56 m
AREA: 1.40 m² • PERIMETER: 4.92 m

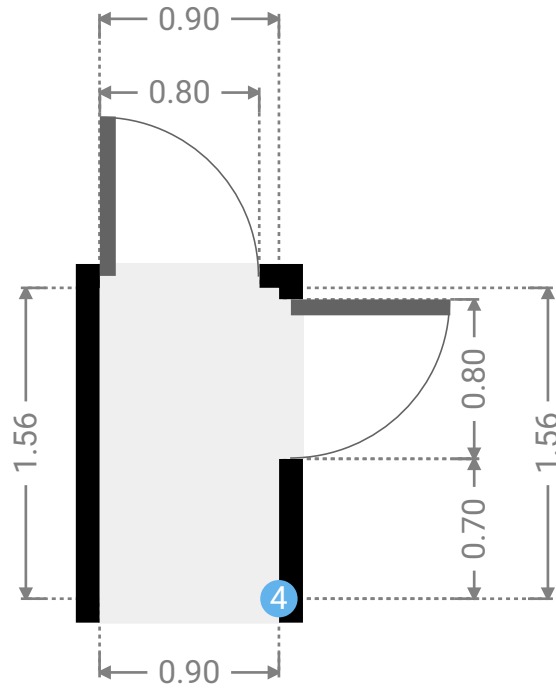
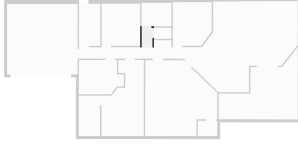

▼ Hall/Ground Floor

4 OPENING

Height
0.00 m



▼ Toilet Ground Floor

WIDTH: 1.50 m • LENGTH: 0.94 m
AREA: 1.41 m² • PERIMETER: 4.88 m

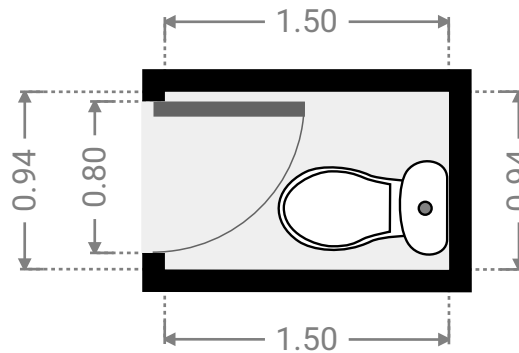

▼ Bathroom Ground Floor

WIDTH: 2.54 m • LENGTH: 2.00 m
AREA: 5.08 m² • PERIMETER: 9.08 m

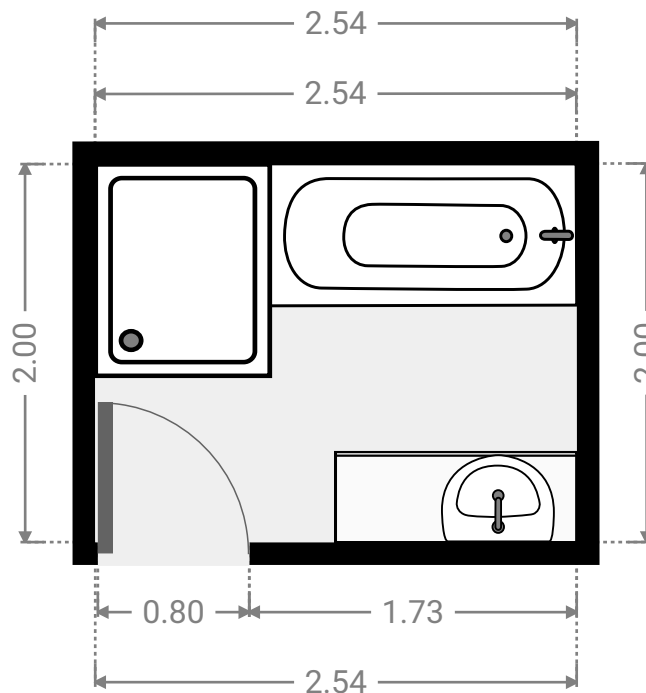
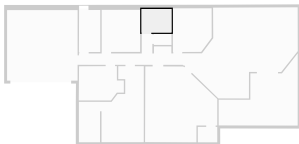

1 Magnolia Court

FLOORS: 1



▼ Primary Bedroom Ground Floor

WIDTH: 3.60 m • LENGTH: 6.47 m
AREA: 18.38 m² • PERIMETER: 20.97 m

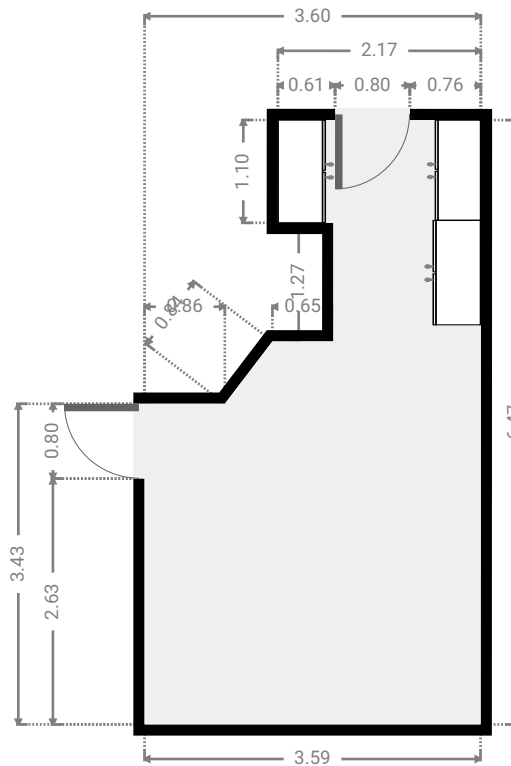
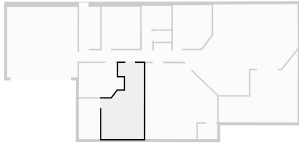

▼ Bathroom Ground Floor

WIDTH: 1.80 m • LENGTH: 3.44 m
AREA: 6.19 m² • PERIMETER: 10.48 m

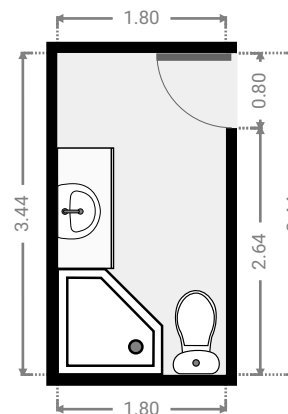

1 Magnolia Court

FLOORS: 1

▼ Bedroom Ground Floor

WIDTH: 3.84 m • LENGTH: 2.92 m
AREA: 9.86 m² • PERIMETER: 13.14 m

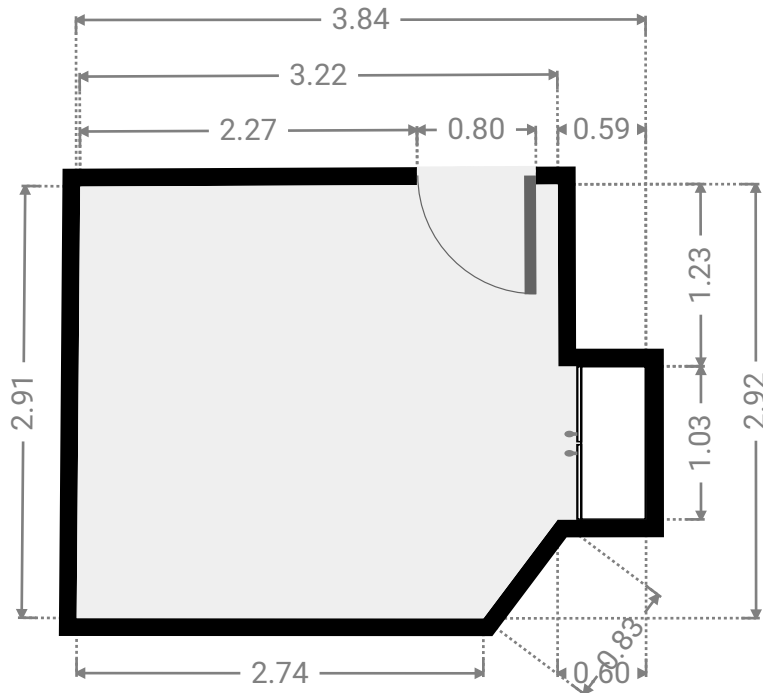
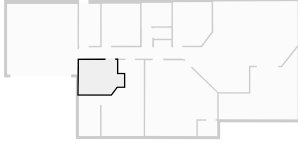

▼ Bedroom Ground Floor

WIDTH: 3.27 m • LENGTH: 3.58 m
AREA: 11.71 m² • PERIMETER: 13.70 m

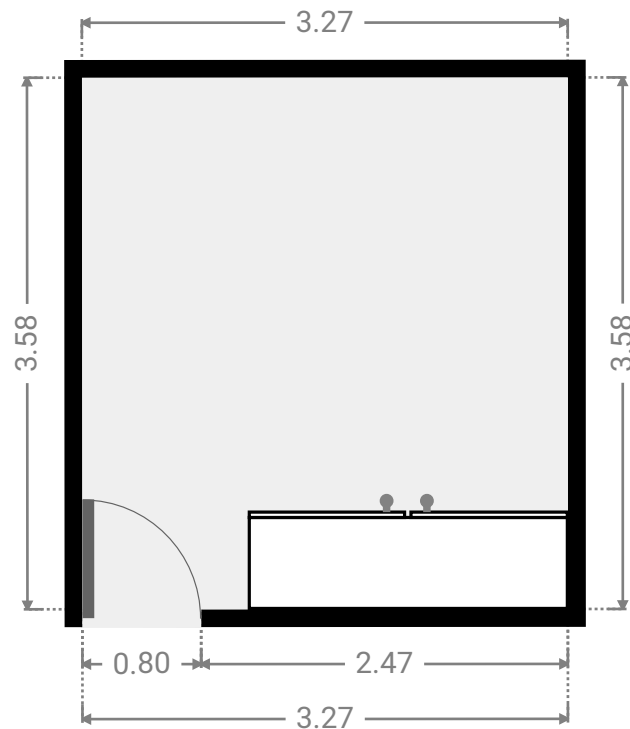
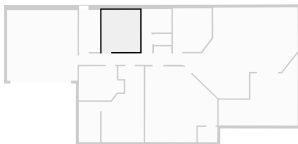

1 Magnolia Court

FLOORS: 1

▼ Laundry Room Ground Floor

WIDTH: 1.82 m • LENGTH: 3.58 m
AREA: 6.47 m² • PERIMETER: 10.77 m

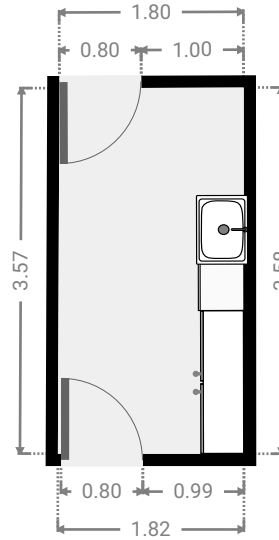
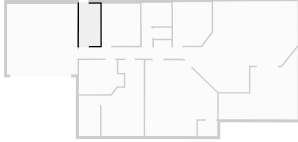

▼ Garage Ground Floor

WIDTH: 6.00 m • LENGTH: 6.00 m
AREA: 36.00 m² • PERIMETER: 24.00 m

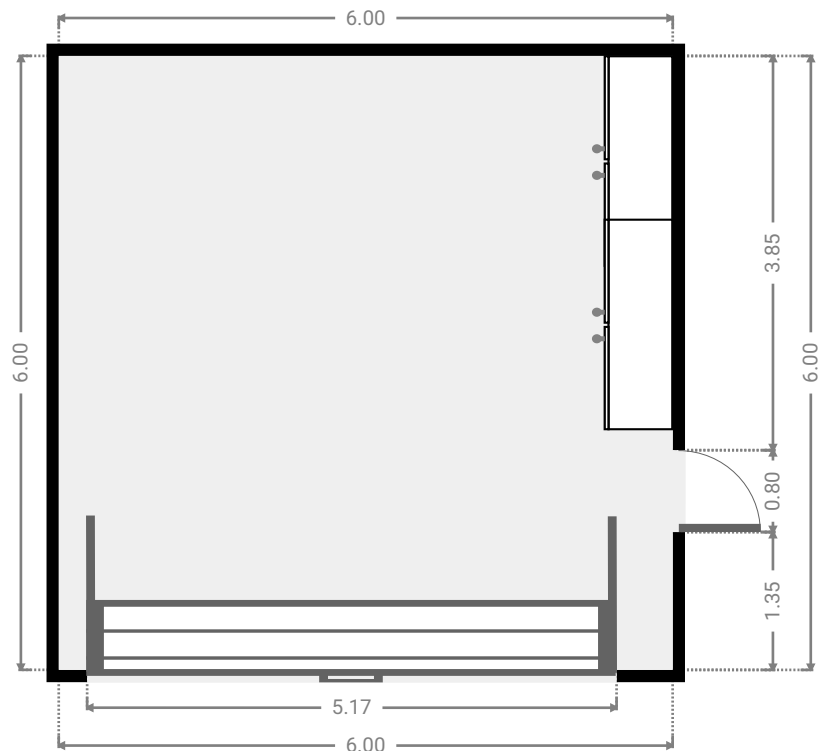
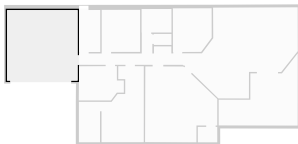

1 Magnolia Court

FLOORS: 1



▼ Other Ground Floor

WIDTH: 6.73 m • LENGTH: 6.15 m
AREA: 24.92 m² • PERIMETER: 24.86 m

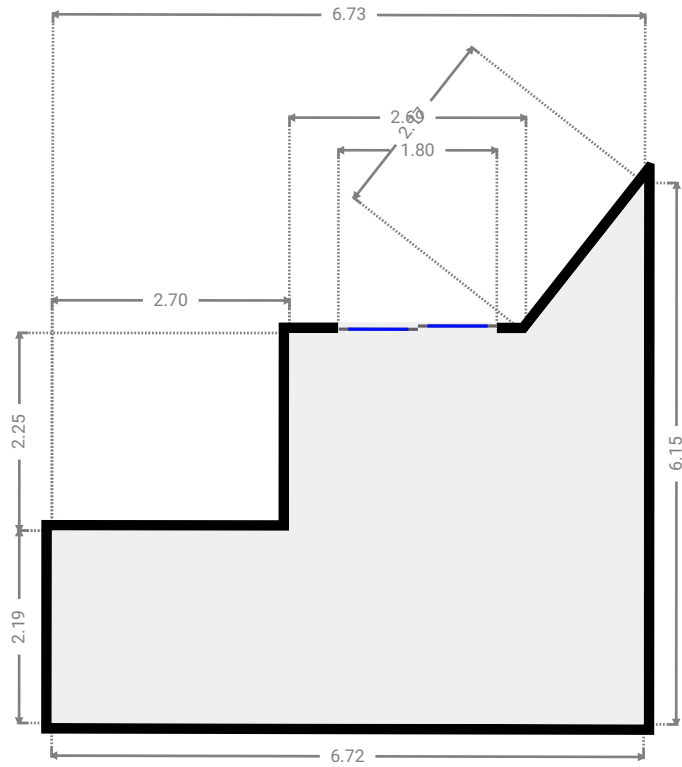
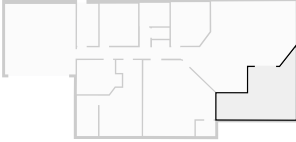

▼ Other Ground Floor

WIDTH: 1.65 m • LENGTH: 1.31 m
AREA: 2.17 m² • PERIMETER: 5.93 m

