

1 Clara Place

Created on
2021-08-05

Floors
1

▼ Ground Floor



▼ Hall Ground Floor

WIDTH: 1.54 m • LENGTH: 1.56 m
AREA: 2.40 m² • PERIMETER: 6.20 m

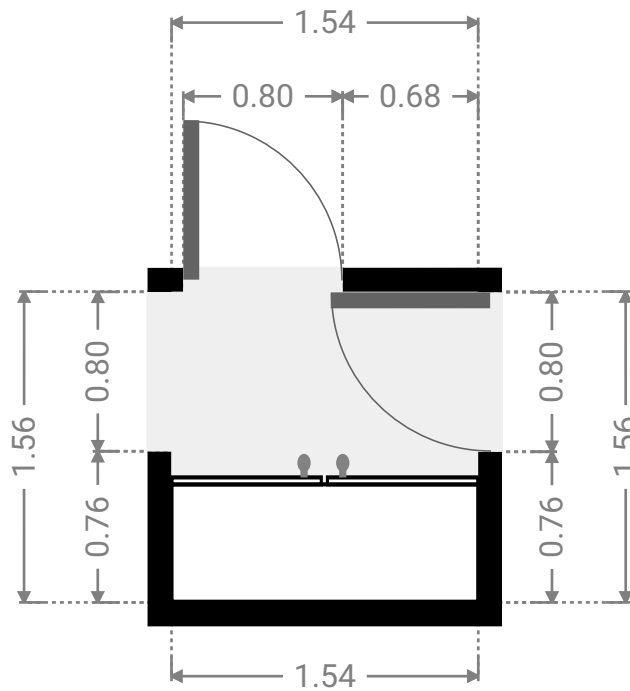
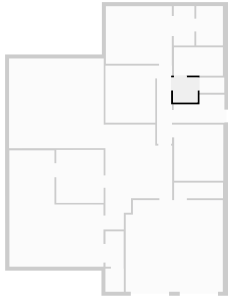

▼ Other Ground Floor

WIDTH: 1.15 m • LENGTH: 1.45 m
AREA: 1.67 m² • PERIMETER: 5.21 m

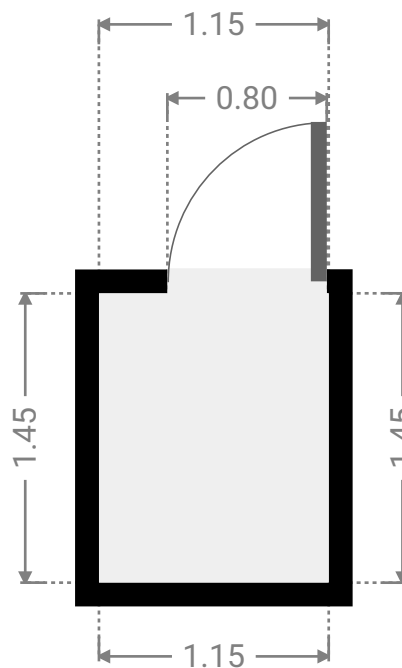
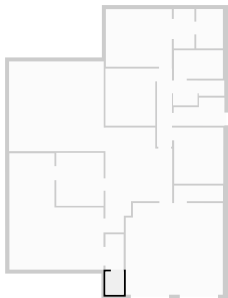

▼ Other Ground Floor

WIDTH: 5.94 m • LENGTH: 5.63 m
AREA: 33.45 m² • PERIMETER: 23.14 m

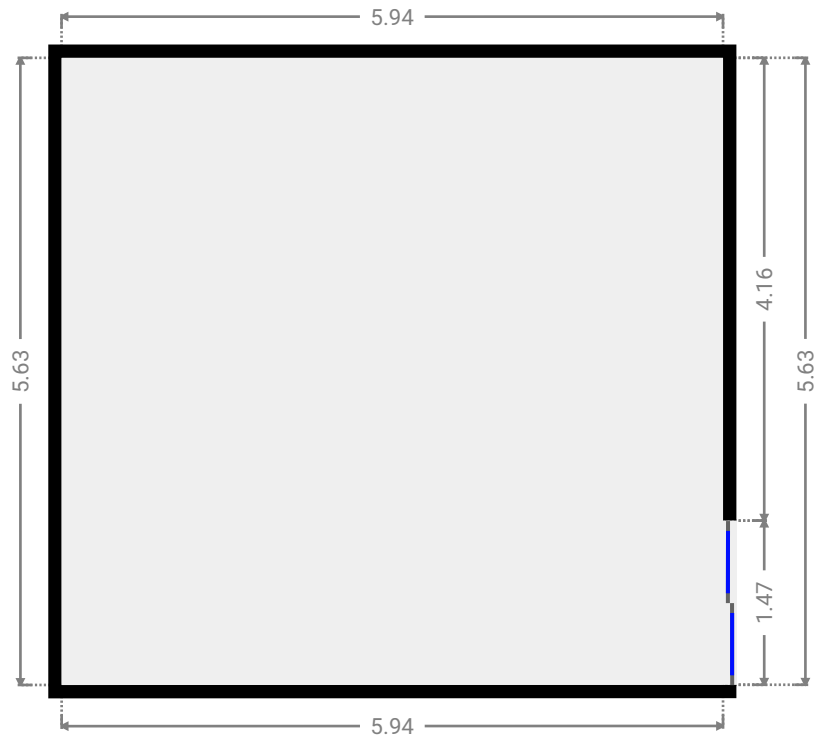
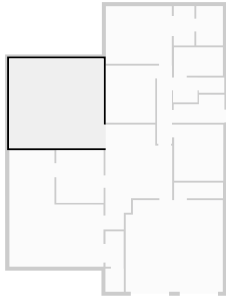

▼ Bathroom Ground Floor

WIDTH: 1.67 m • LENGTH: 2.47 m
AREA: 4.12 m² • PERIMETER: 8.27 m

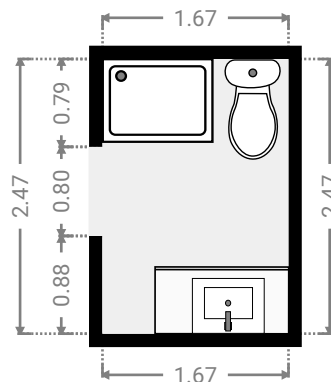
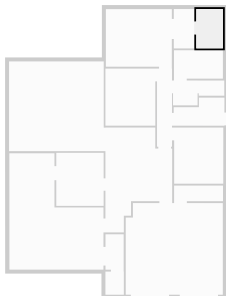

▼ **Hall**
Ground Floor

WIDTH: 1.29 m • LENGTH: 2.47 m
AREA: 3.19 m² • PERIMETER: 7.52 m

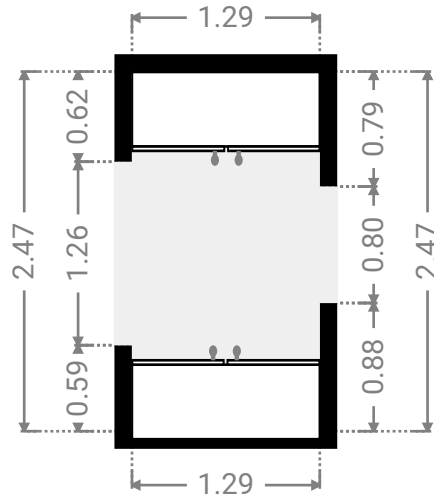
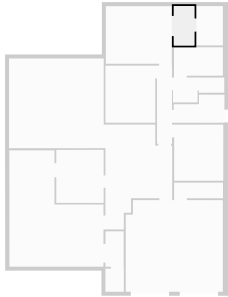

▼ **Master Bedroom**
Ground Floor

WIDTH: 4.14 m • LENGTH: 3.61 m
AREA: 14.95 m² • PERIMETER: 15.50 m

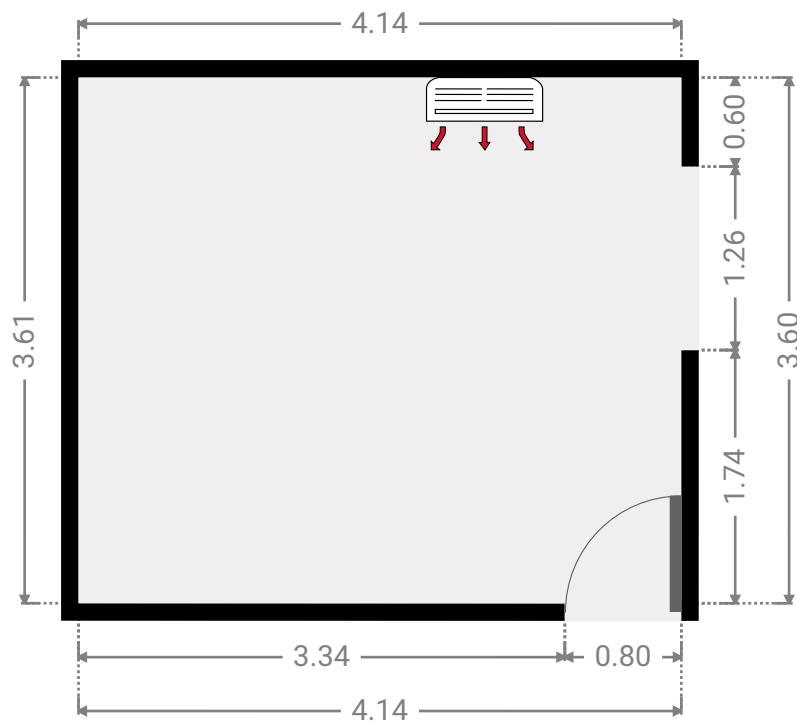
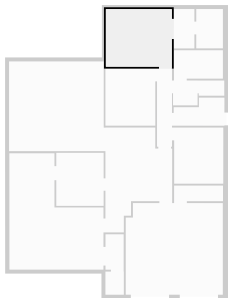

▼ **Bedroom**
Ground Floor

WIDTH: 3.13 m • LENGTH: 3.58 m
AREA: 11.20 m² • PERIMETER: 13.42 m

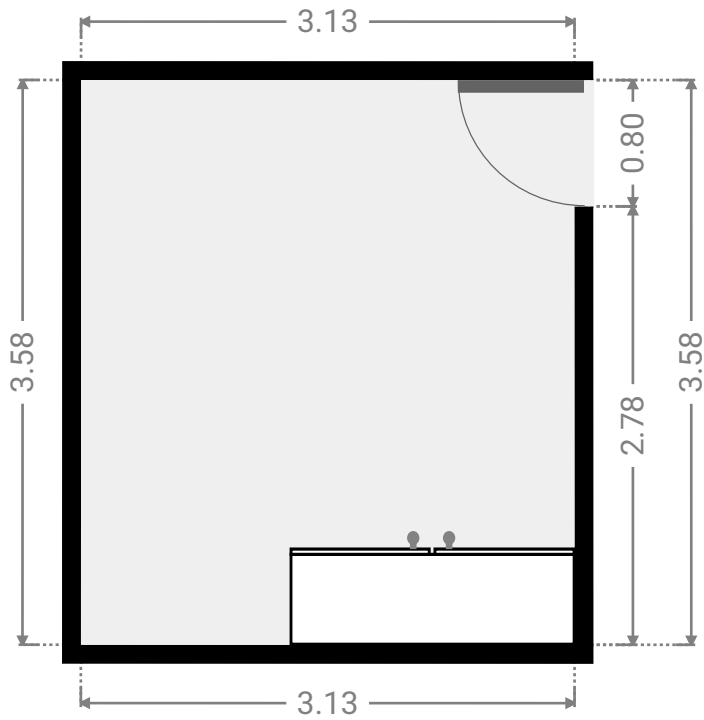
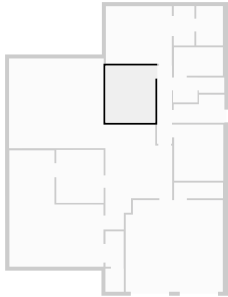

▼ **Bathroom**
Ground Floor

WIDTH: 3.07 m • LENGTH: 1.78 m
AREA: 5.46 m² • PERIMETER: 9.70 m

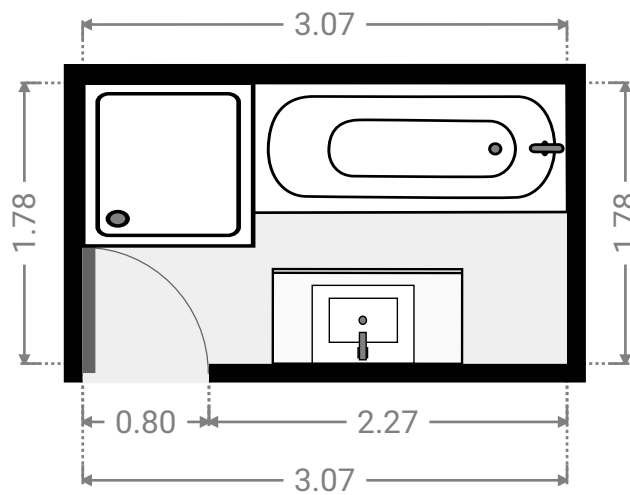
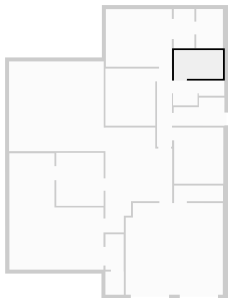

▼ Toilet Ground Floor

WIDTH: 1.60 m • LENGTH: 0.95 m
AREA: 1.52 m² • PERIMETER: 5.10 m

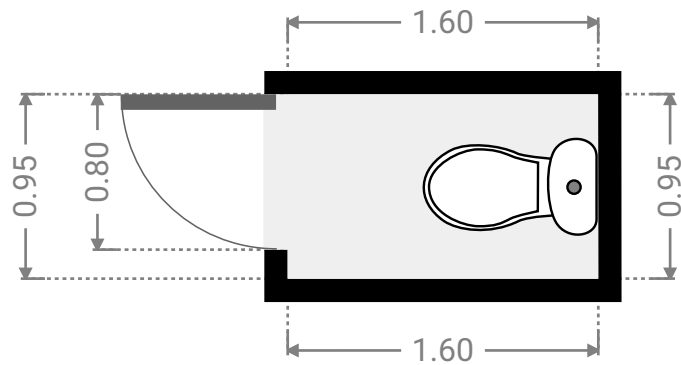
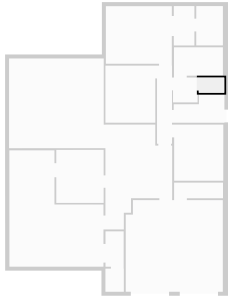

▼ Hall Ground Floor

WIDTH: 1.14 m • LENGTH: 2.22 m
AREA: 2.53 m² • PERIMETER: 6.72 m

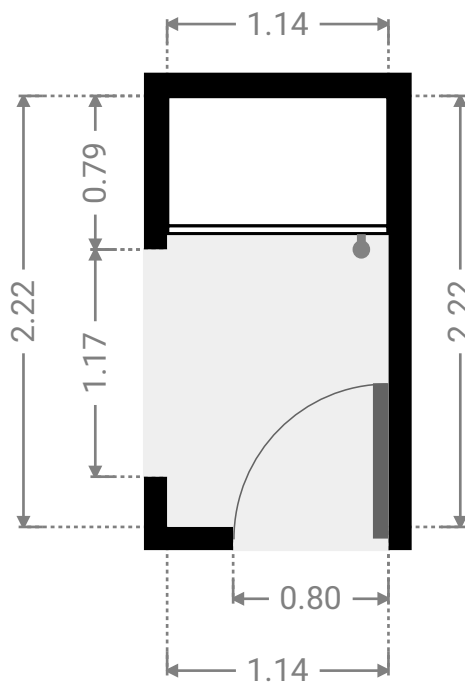
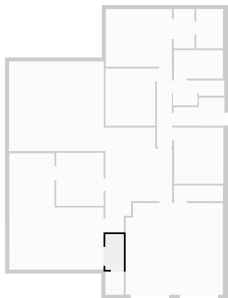

▼ Laundry Room Ground Floor

WIDTH: 3.18 m • LENGTH: 1.76 m
AREA: 4.65 m² • PERIMETER: 9.88 m

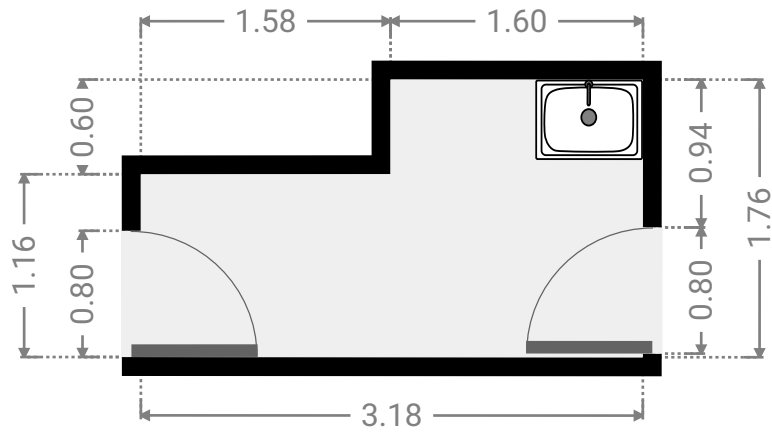
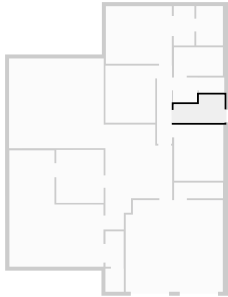

▼ Bedroom Ground Floor

WIDTH: 3.08 m • LENGTH: 3.52 m
AREA: 10.85 m² • PERIMETER: 13.20 m

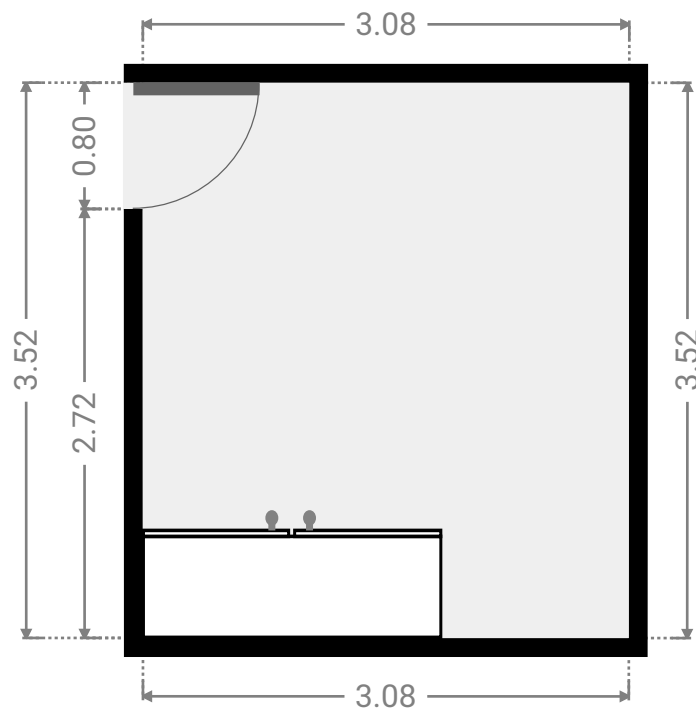
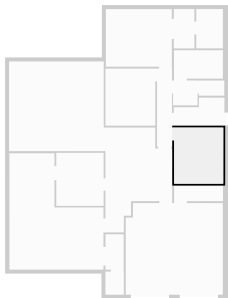

▼ Hall Ground Floor

WIDTH: 0.94 m • LENGTH: 4.90 m
AREA: 4.60 m² • PERIMETER: 11.68 m

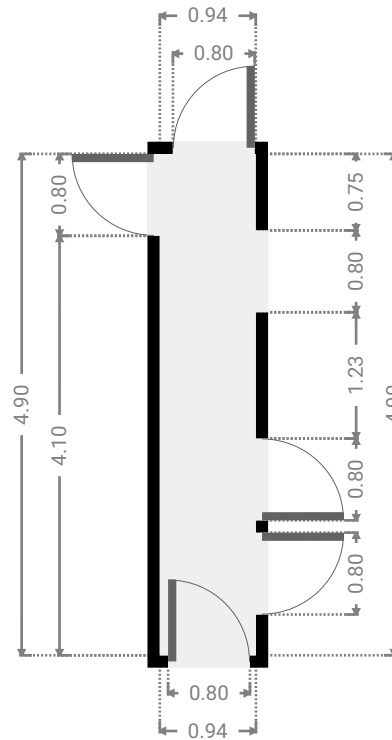
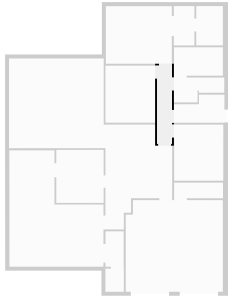

▼ Other Ground Floor

WIDTH: 3.07 m • LENGTH: 0.98 m
AREA: 3.01 m² • PERIMETER: 8.10 m

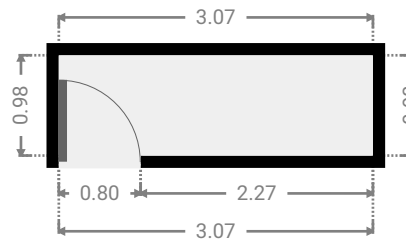
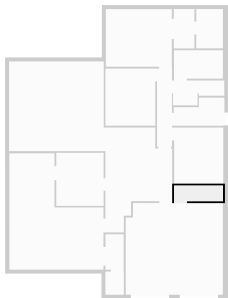

▼ Garage Ground Floor

WIDTH: 6.09 m • LENGTH: 5.75 m
AREA: 34.61 m² • PERIMETER: 23.68 m

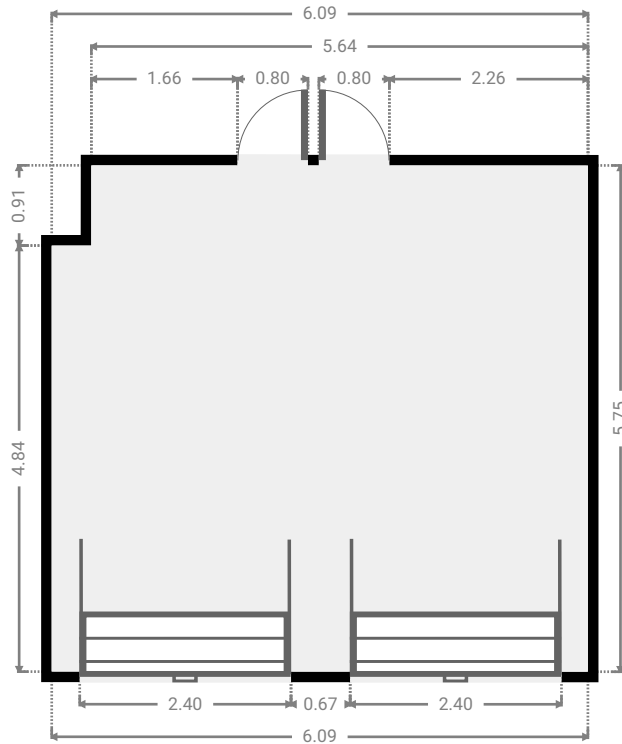
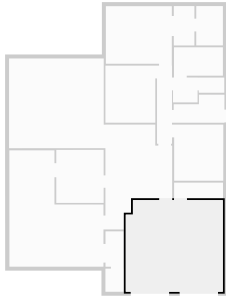

▼ Dining Room Ground Floor

WIDTH: 4.19 m • LENGTH: 6.58 m
AREA: 20.63 m² • PERIMETER: 21.54 m

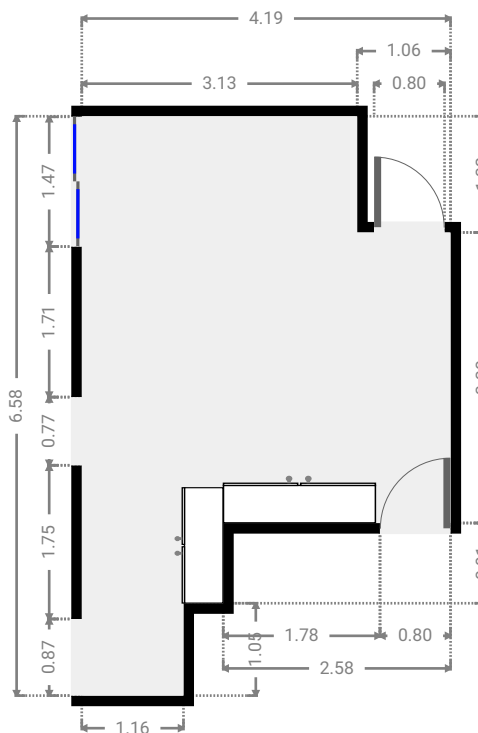
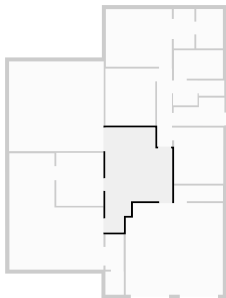

▼ Kitchen Ground Floor

WIDTH: 2.97 m • LENGTH: 3.33 m
AREA: 9.89 m² • PERIMETER: 12.60 m

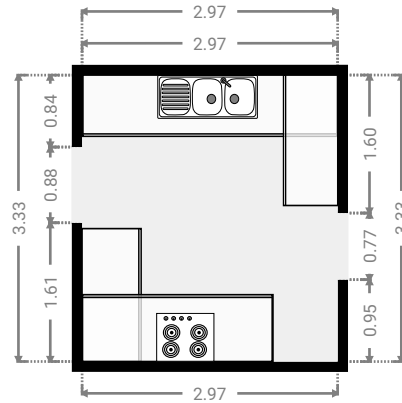
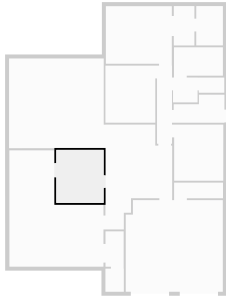

▼ Living Room Ground Floor

WIDTH: 5.91 m • LENGTH: 7.30 m
AREA: 32.64 m² • PERIMETER: 26.41 m

