

1 Callistemon Close

Ground Floor

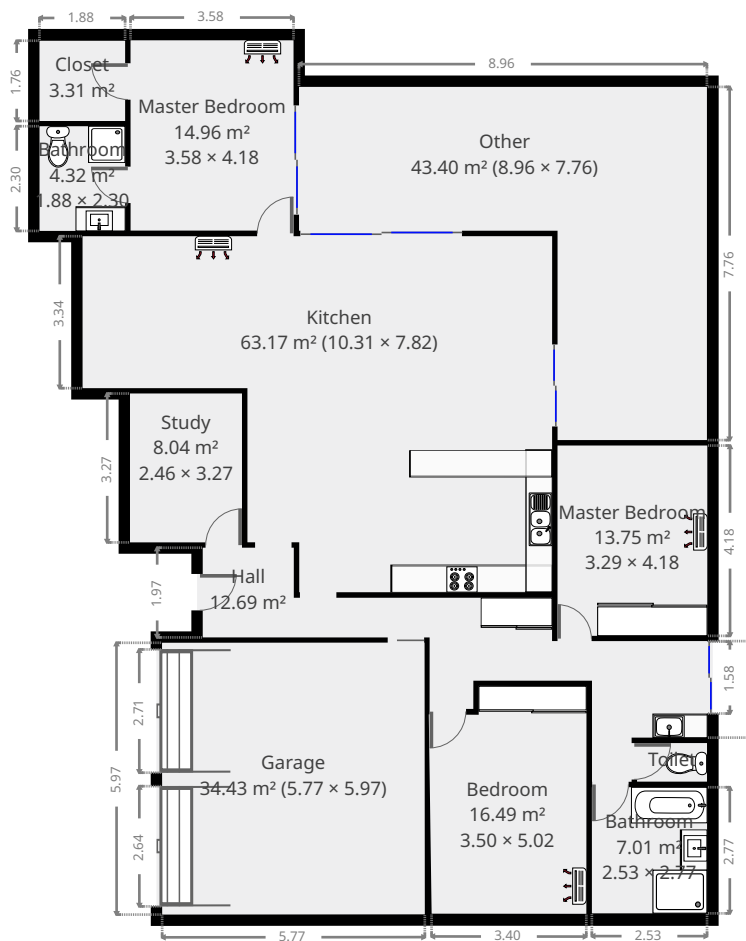

THIS FLOORPLAN IS PROVIDED WITHOUT WARRANTY OF ANY KIND. SENSOPIA DISCLAIMS ANY WARRANTY INCLUDING, WITHOUT LIMITATION, SATISFACTORY QUALITY OR ACCURACY OF DIMENSIONS.

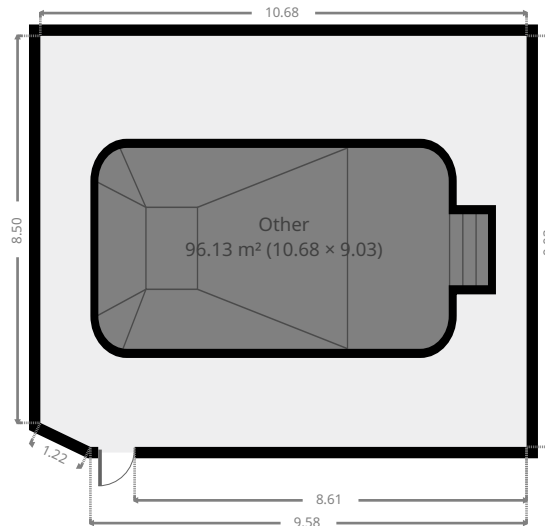

1 Callistemon Close

Hall

Width: 3.54 m
 Length: 8.43 m
 Area: 12.69 m²
 Perimeter: 23.94 m

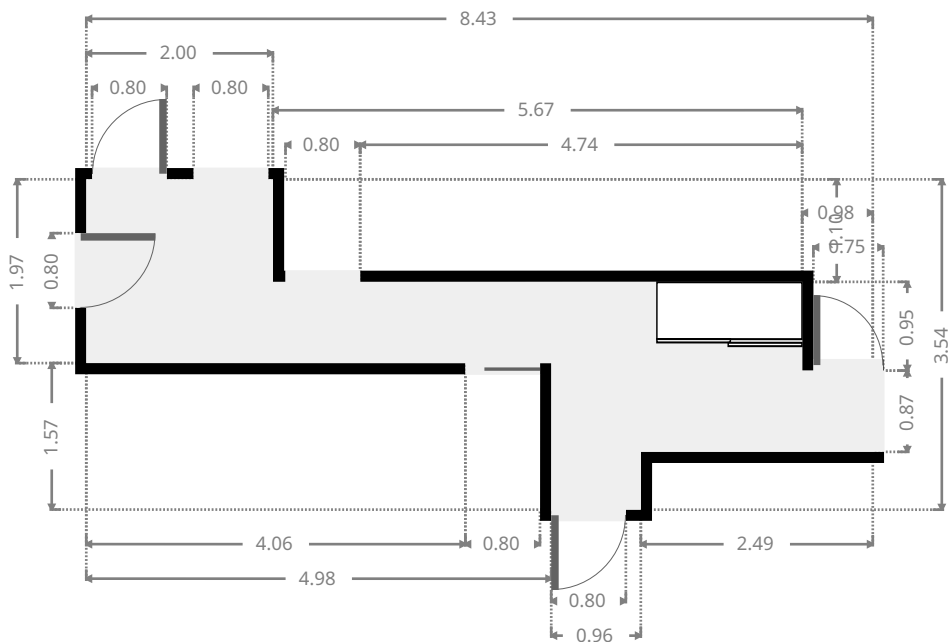
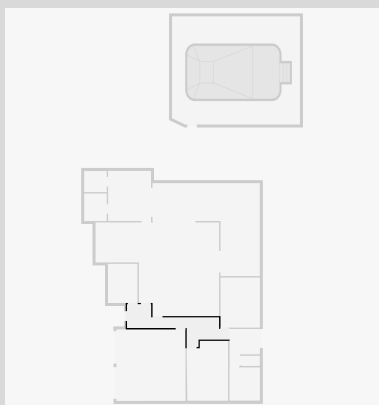

Laundry Room

Width: 2.53 m
 Length: 3.09 m
 Area: 6.21 m²
 Perimeter: 11.24 m

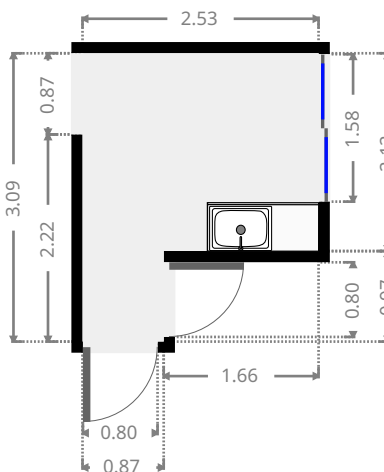
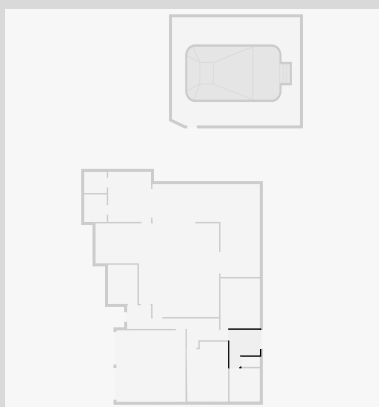

THIS FLOORPLAN IS PROVIDED WITHOUT WARRANTY OF ANY KIND. SENSOPIA DISCLAIMS ANY WARRANTY INCLUDING, WITHOUT LIMITATION, SATISFACTORY QUALITY OR ACCURACY OF DIMENSIONS.

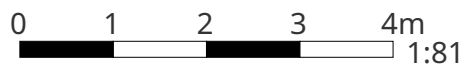

1 Callistemon Close

Bathroom

Width: 2.53 m
Length: 2.77 m
Area: 7.01 m²
Perimeter: 10.60 m

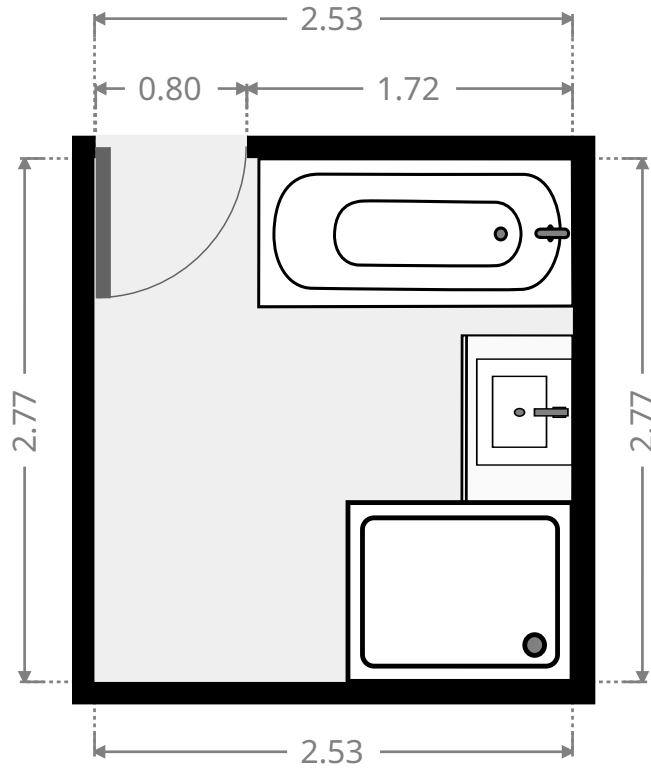
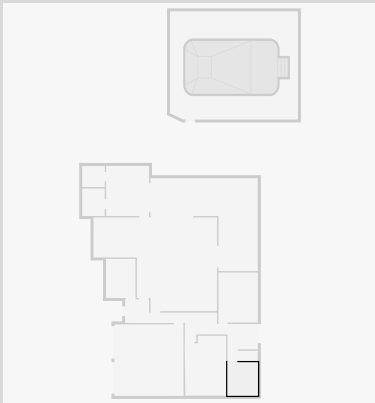

Toilet / Half Bath

Width: 0.85 m
Length: 1.54 m
Area: 1.30 m²
Perimeter: 4.77 m

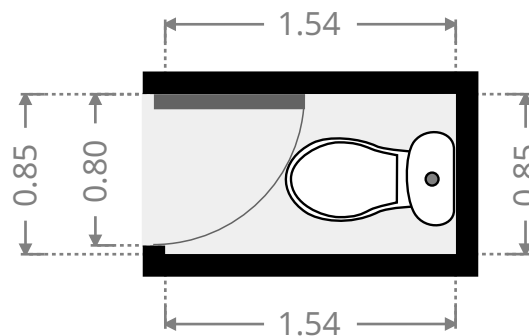
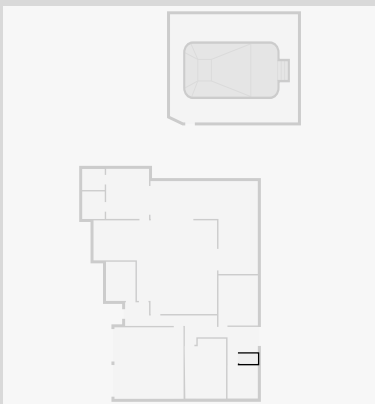

1 Callistemon Close

Master Bedroom

Width: 3.29 m
Length: 4.18 m
Area: 13.75 m²
Perimeter: 14.94 m

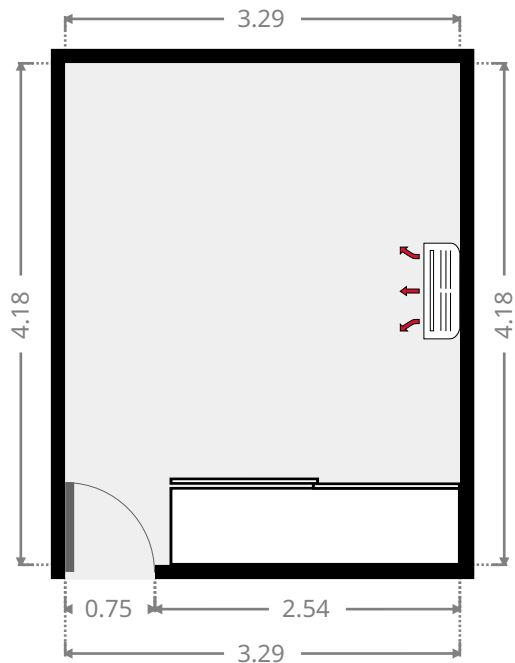
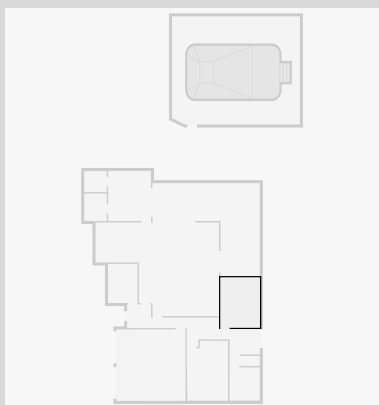

Bedroom

Width: 3.50 m
Length: 5.02 m
Area: 16.49 m²
Perimeter: 16.87 m

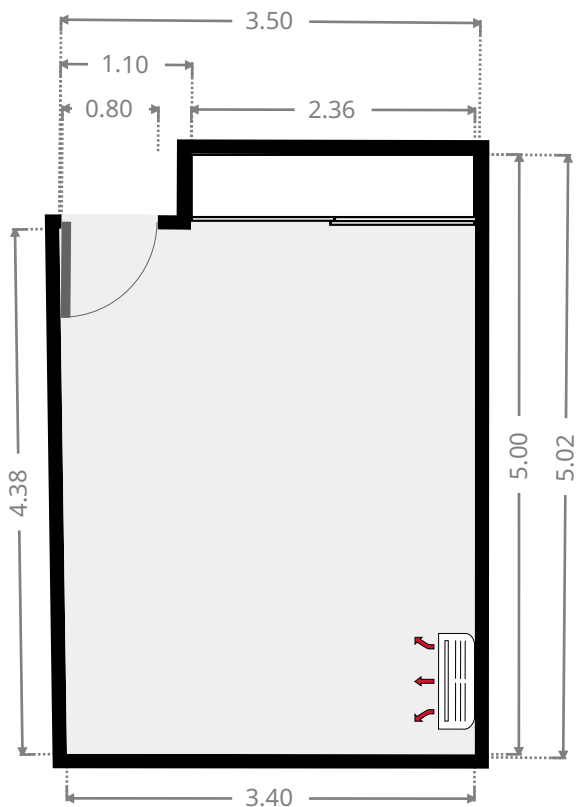
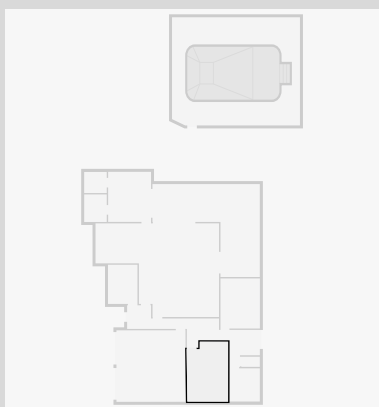

THIS FLOORPLAN IS PROVIDED WITHOUT WARRANTY OF ANY KIND. SENSOPIA DISCLAIMS ANY WARRANTY INCLUDING, WITHOUT LIMITATION, SATISFACTORY QUALITY OR ACCURACY OF DIMENSIONS.

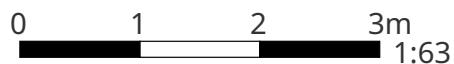

1 Callistemon Close

Garage

Width: 5.77 m
 Length: 5.97 m
 Area: 34.43 m²
 Perimeter: 23.47 m

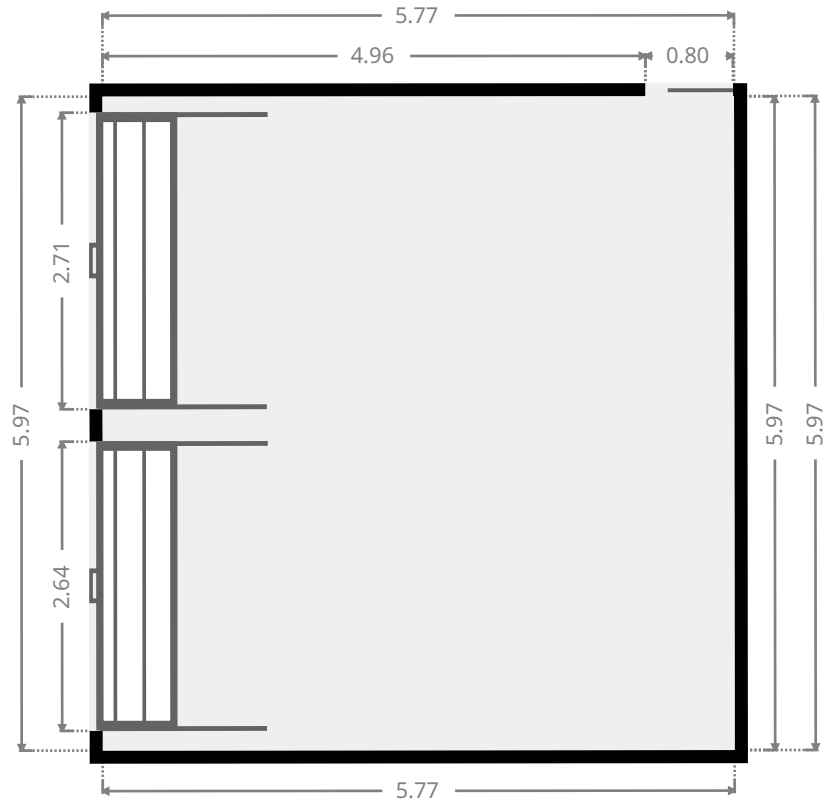
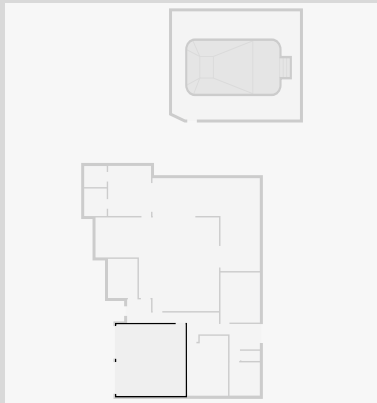

Study

Width: 2.46 m
 Length: 3.27 m
 Area: 8.04 m²
 Perimeter: 11.46 m

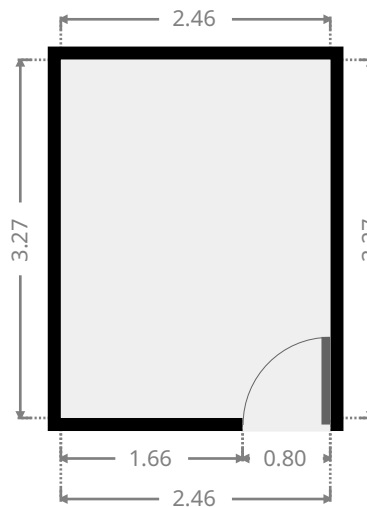
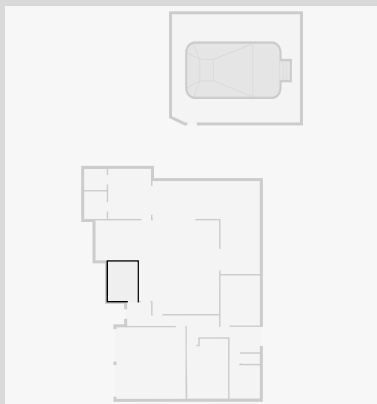

THIS FLOORPLAN IS PROVIDED WITHOUT WARRANTY OF ANY KIND. SENSOPIA DISCLAIMS ANY WARRANTY INCLUDING, WITHOUT LIMITATION, SATISFACTORY QUALITY OR ACCURACY OF DIMENSIONS.



1 Callistemon Close

Kitchen

Width: 7.82 m
Length: 10.31 m
Area: 63.17 m²
Perimeter: 36.27 m

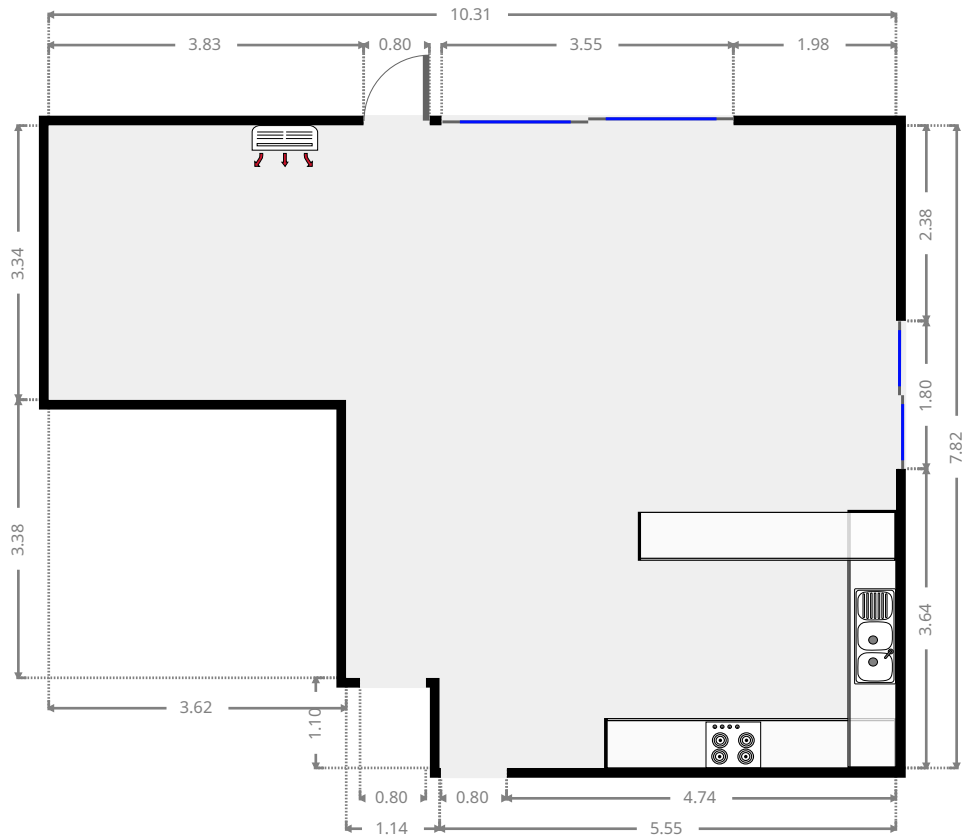
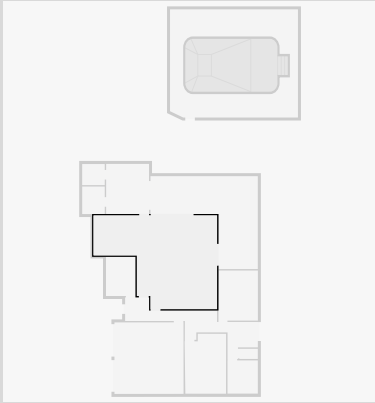

THIS FLOORPLAN IS PROVIDED WITHOUT WARRANTY OF ANY KIND. SENSOPIA DISCLAIMS ANY WARRANTY INCLUDING, WITHOUT LIMITATION, SATISFACTORY QUALITY OR ACCURACY OF DIMENSIONS.

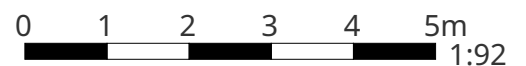

1 Callistemon Close

Master Bedroom

Width: 3.58 m
 Length: 4.18 m
 Area: 14.96 m²
 Perimeter: 15.52 m

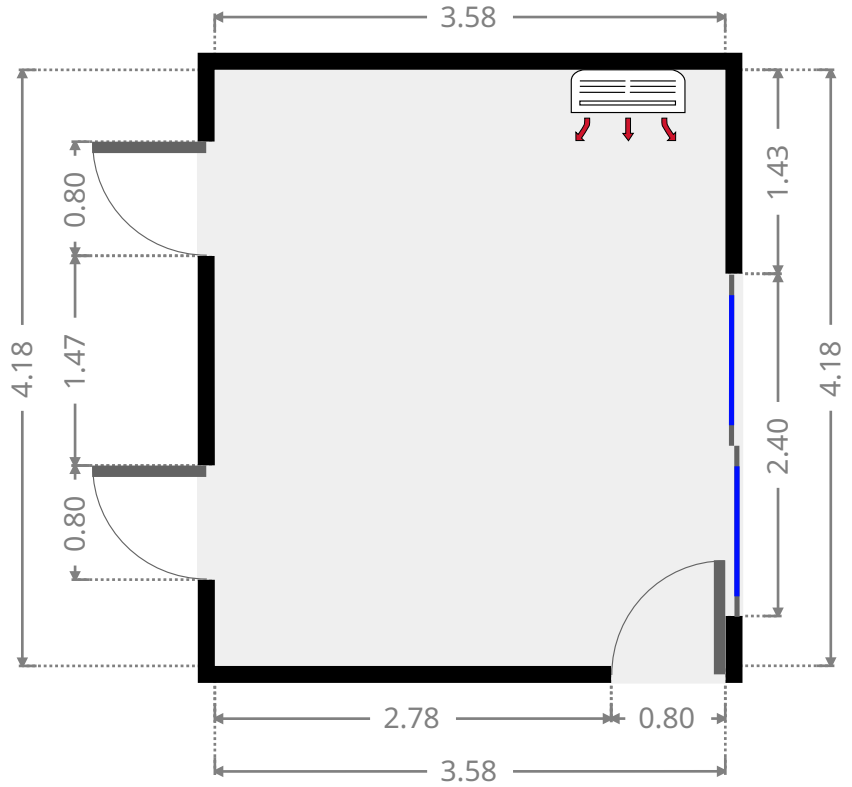
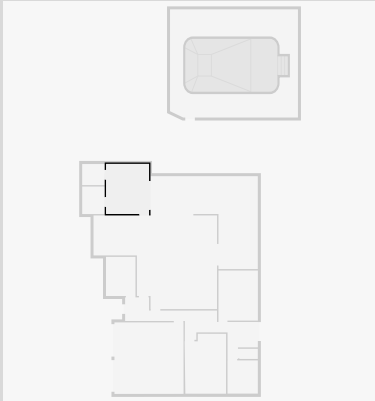

Bathroom

Width: 1.88 m
 Length: 2.30 m
 Area: 4.32 m²
 Perimeter: 8.36 m

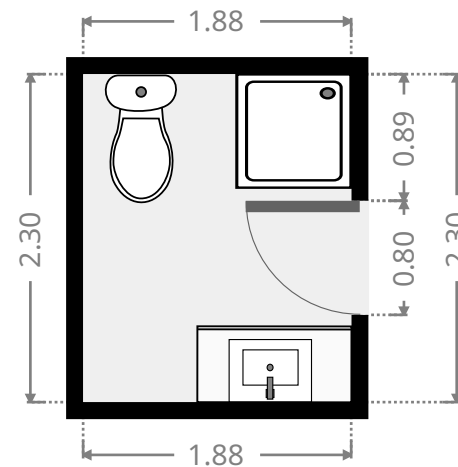
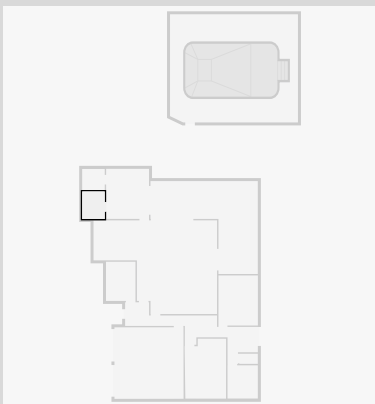

THIS FLOORPLAN IS PROVIDED WITHOUT WARRANTY OF ANY KIND. SENSOPIA DISCLAIMS ANY WARRANTY INCLUDING, WITHOUT LIMITATION, SATISFACTORY QUALITY OR ACCURACY OF DIMENSIONS.

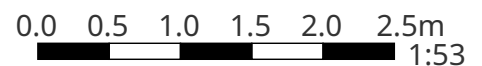

1 Callistemon Close

Closet

Width: 1.76 m
 Length: 1.88 m
 Area: 3.31 m²
 Perimeter: 7.29 m

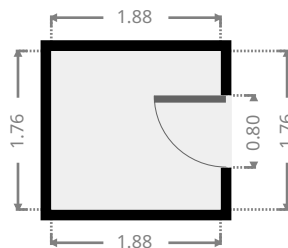
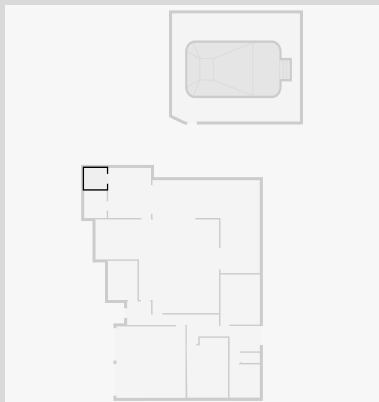

Other

Width: 7.76 m
 Length: 8.96 m
 Area: 43.40 m²
 Perimeter: 33.44 m

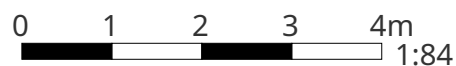
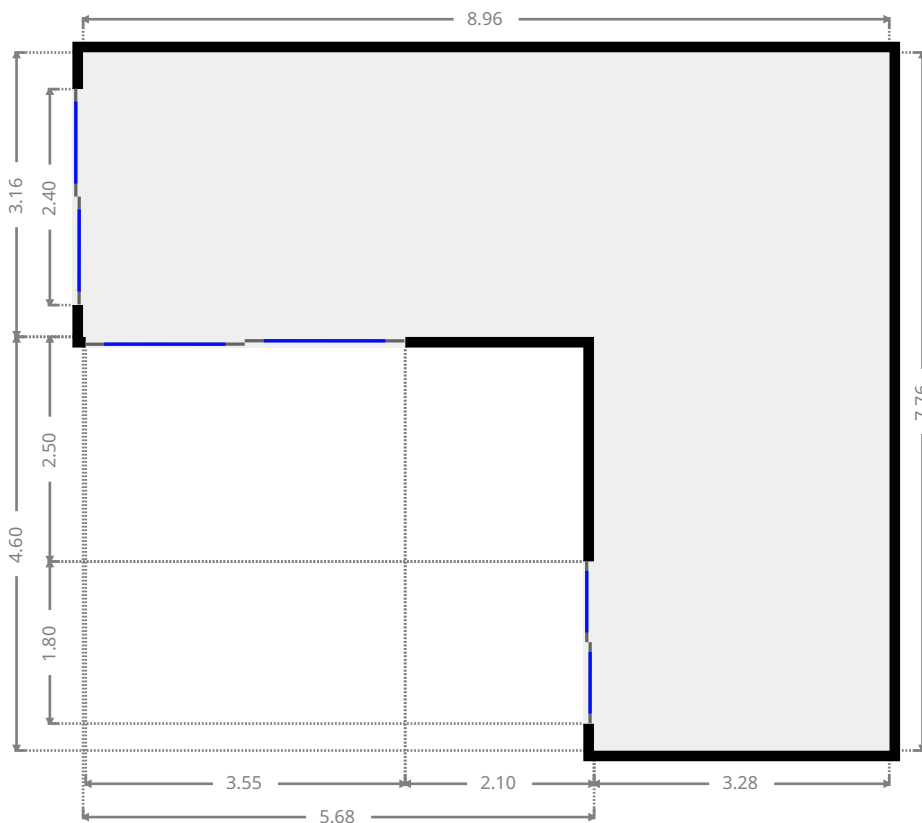
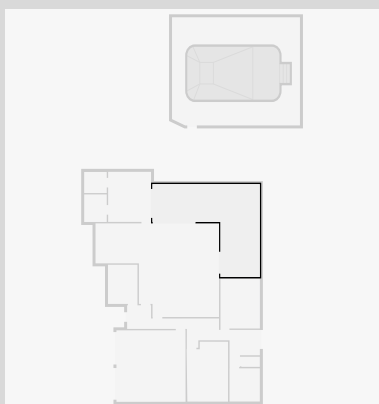

THIS FLOORPLAN IS PROVIDED WITHOUT WARRANTY OF ANY KIND. SENSOPIA DISCLAIMS ANY WARRANTY INCLUDING, WITHOUT LIMITATION, SATISFACTORY QUALITY OR ACCURACY OF DIMENSIONS.

1 Callistemon Close

Other

Width: 9.03 m
Length: 10.68 m
Area: 96.13 m²
Perimeter: 39.01 m

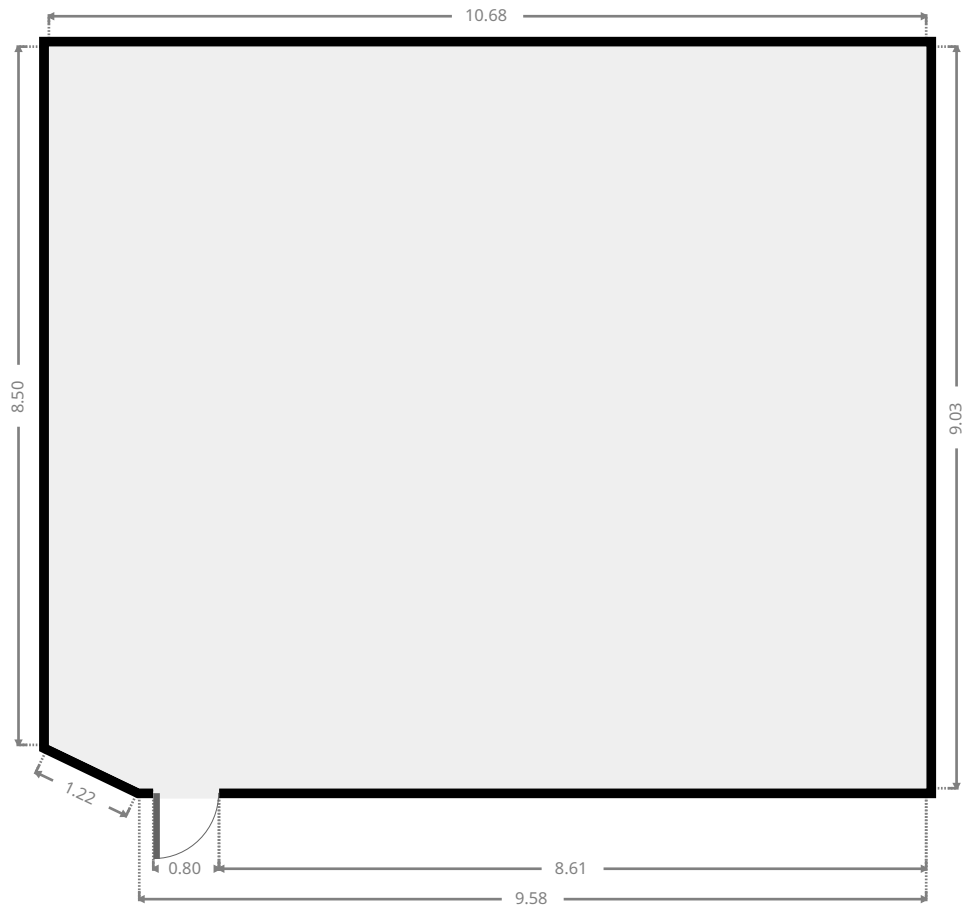
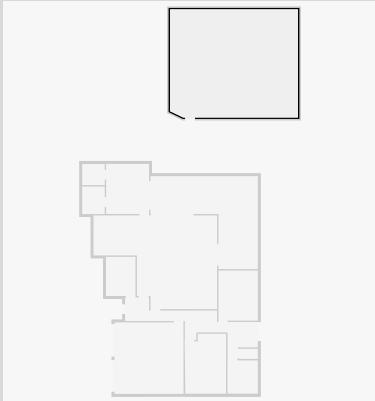

THIS FLOORPLAN IS PROVIDED WITHOUT WARRANTY OF ANY KIND. SENSOPIA DISCLAIMS ANY WARRANTY INCLUDING, WITHOUT LIMITATION, SATISFACTORY QUALITY OR ACCURACY OF DIMENSIONS.

