

1 Agnes Street

SUBMITTED BY
Ray White Rockhampton Casey
stockers@cqoz.com

CREATED ON
2022-12-07

Floors
2

▼ Ground Floor

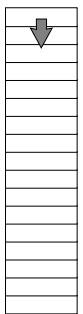
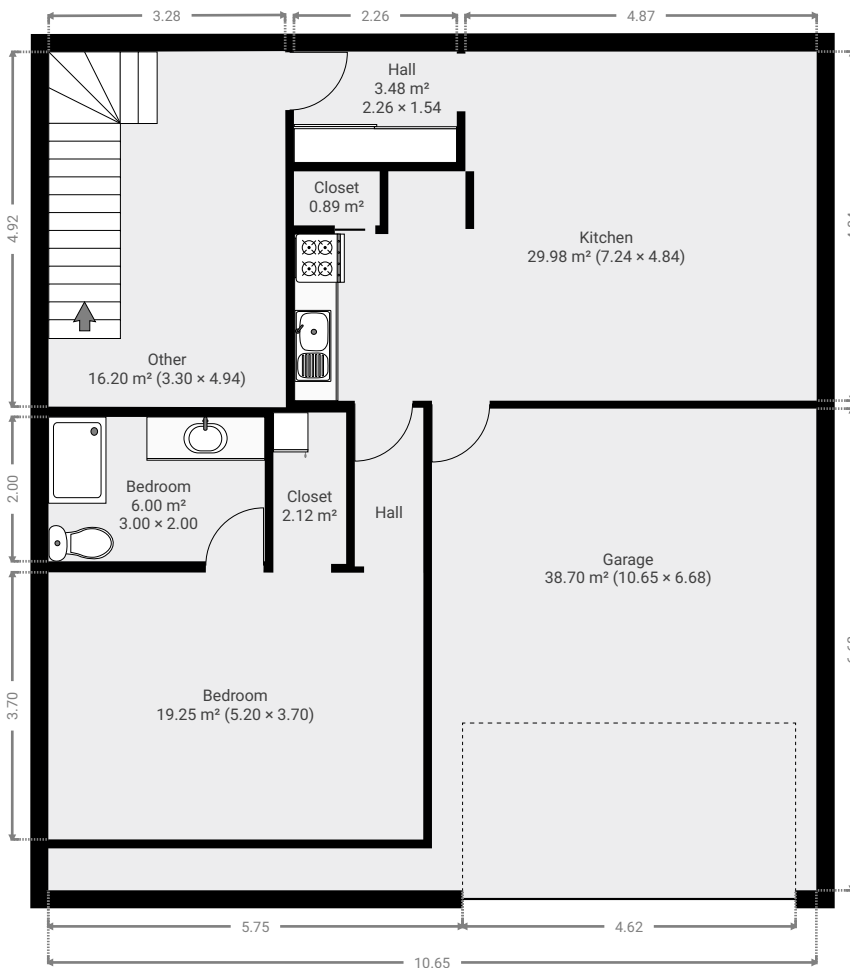
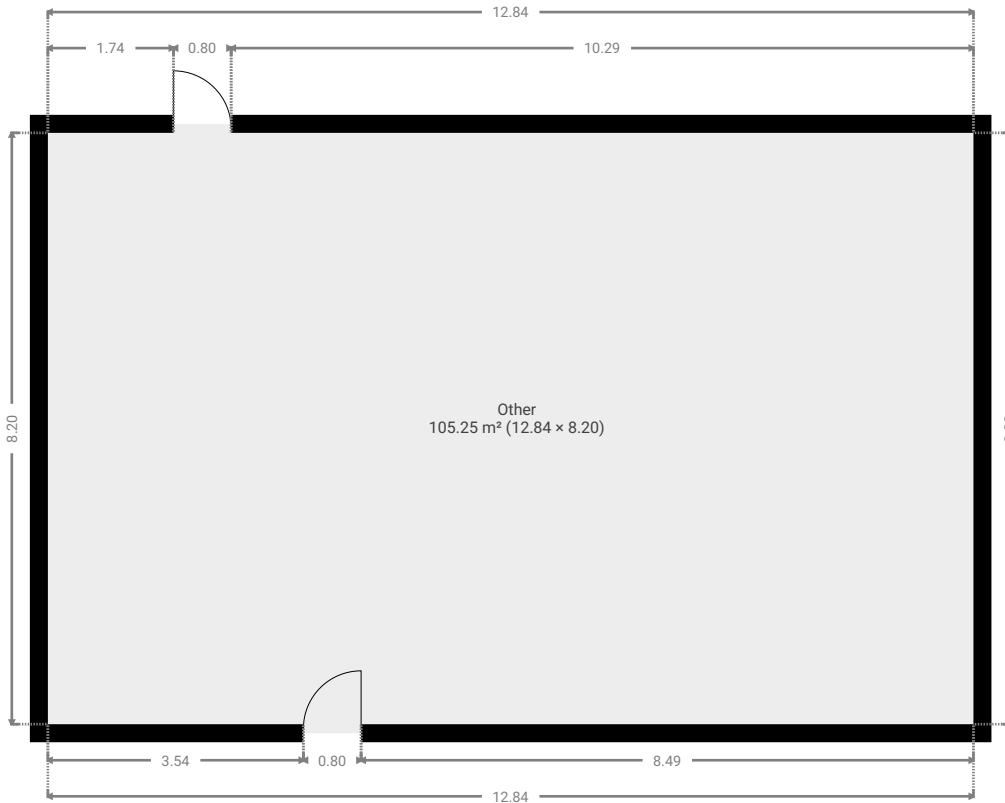

▼ Bedroom Ground Floor

WIDTH: 5.20 m • LENGTH: 3.70 m
AREA: 19.25 m² • PERIMETER: 17.80 m

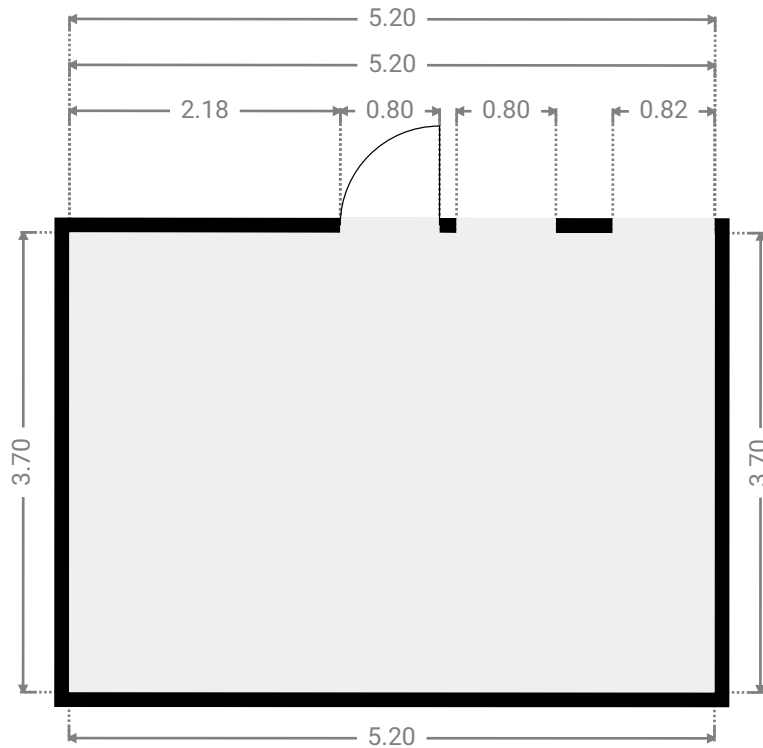
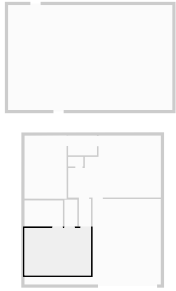

▼ Closet Ground Floor

WIDTH: 1.01 m • LENGTH: 2.10 m
AREA: 2.12 m² • PERIMETER: 6.22 m

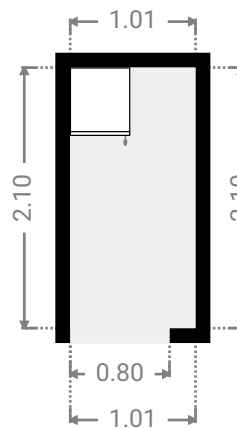
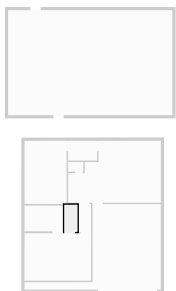

▼ Bedroom Ground Floor

WIDTH: 3.00 m • LENGTH: 2.00 m
AREA: 6.00 m² • PERIMETER: 10.00 m

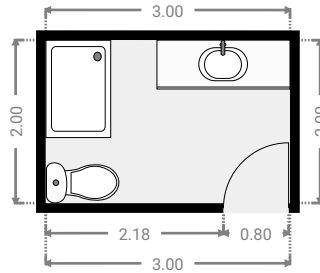
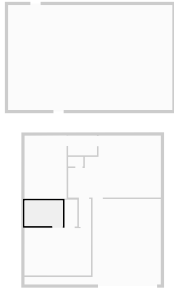

▼ Garage Ground Floor

WIDTH: 10.65 m • LENGTH: 6.68 m
AREA: 38.70 m² • PERIMETER: 34.66 m

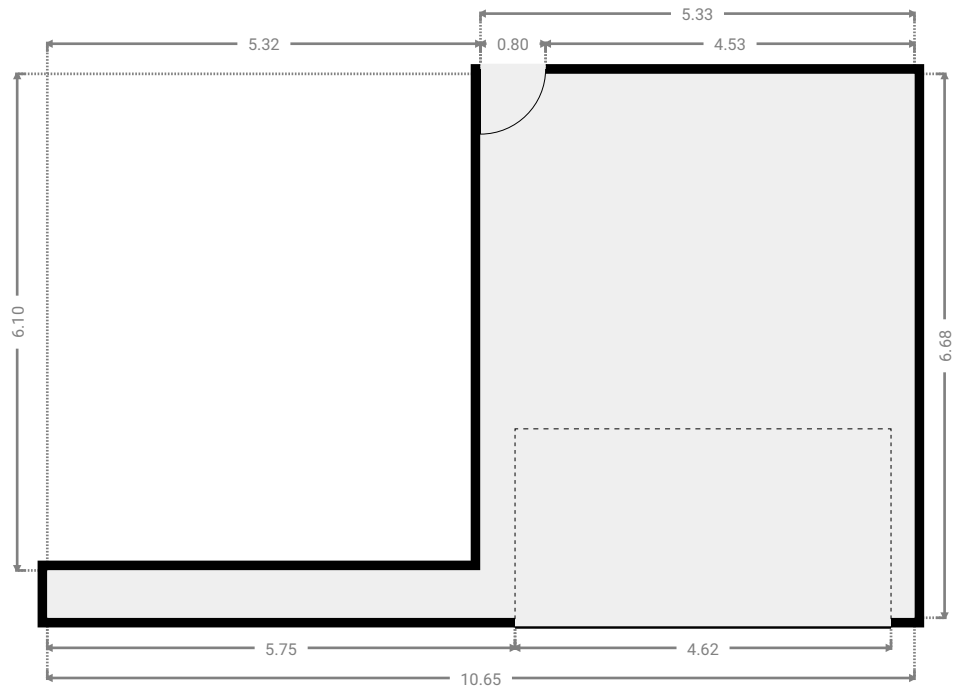
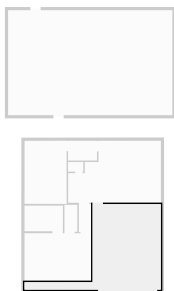

▼ Hall Ground Floor

WIDTH: 0.95 m • LENGTH: 2.20 m
AREA: 2.09 m² • PERIMETER: 6.30 m

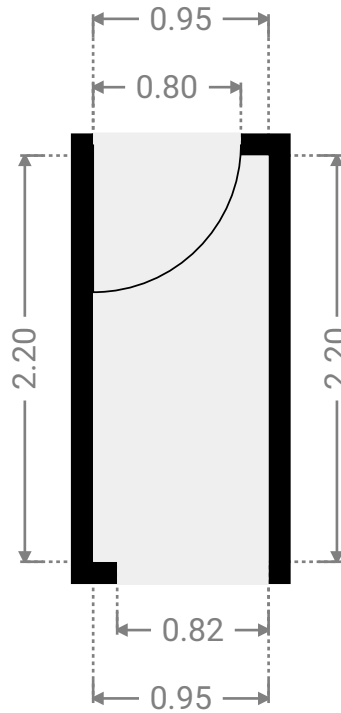
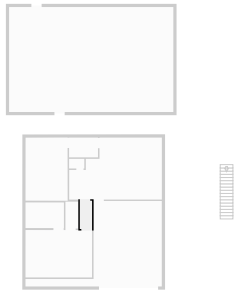

▼ Hall Ground Floor

WIDTH: 2.26 m • LENGTH: 1.54 m
AREA: 3.48 m² • PERIMETER: 7.60 m

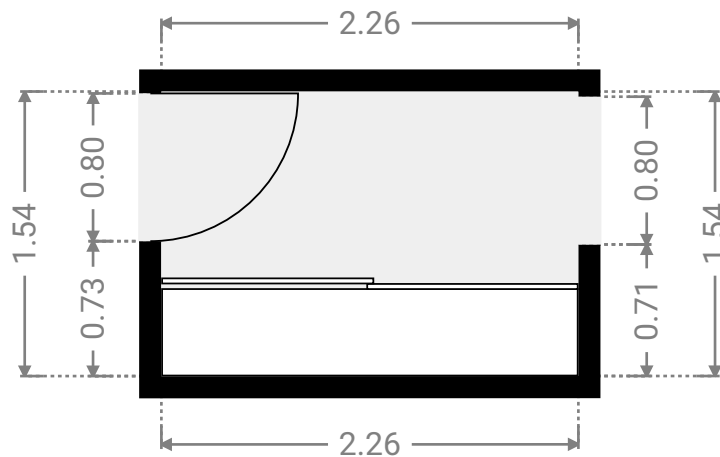
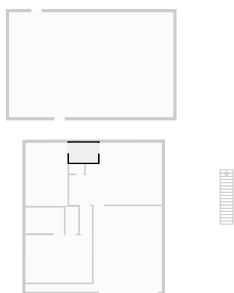

▼ **Kitchen**
Ground Floor

WIDTH: 7.24 m • LENGTH: 4.84 m
AREA: 29.98 m² • PERIMETER: 24.16 m

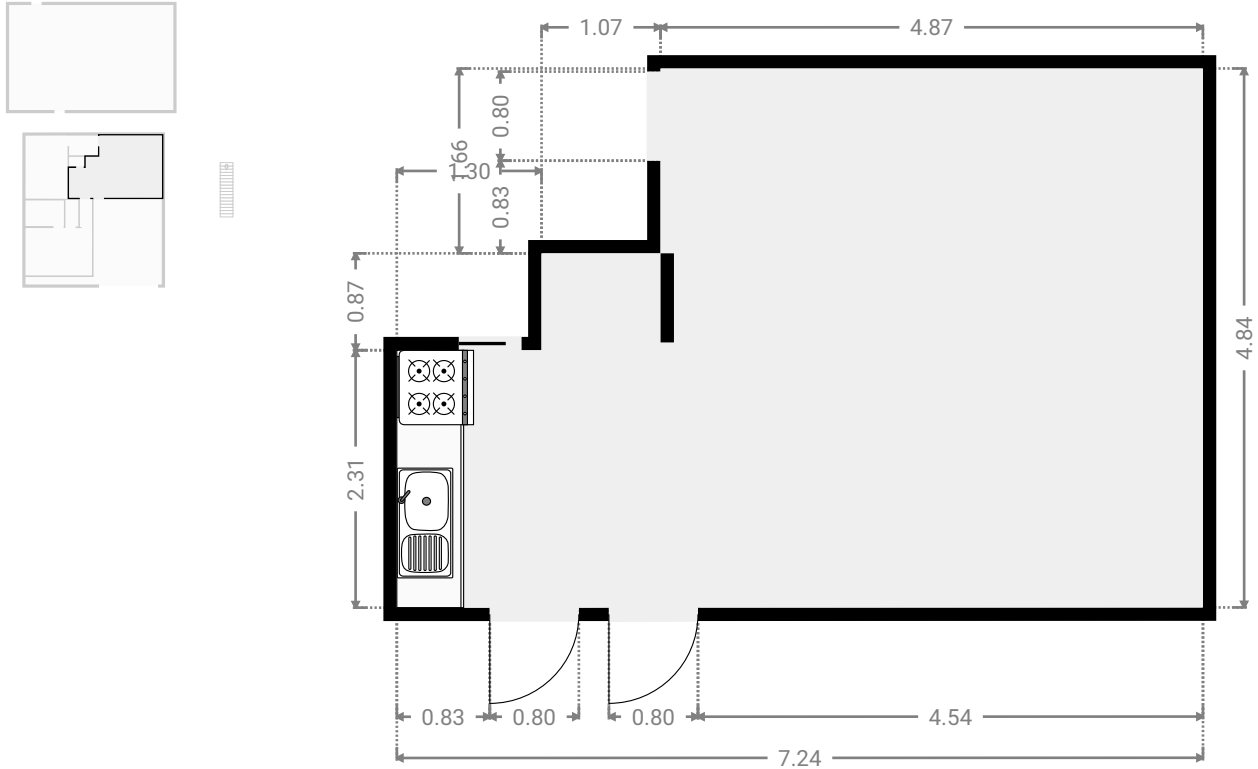

▼ **Closet**
Ground Floor

WIDTH: 1.19 m • LENGTH: 0.75 m
AREA: 0.89 m² • PERIMETER: 3.88 m



▼ Other Ground Floor

WIDTH: 3.30 m • LENGTH: 4.94 m
AREA: 16.20 m² • PERIMETER: 16.43 m

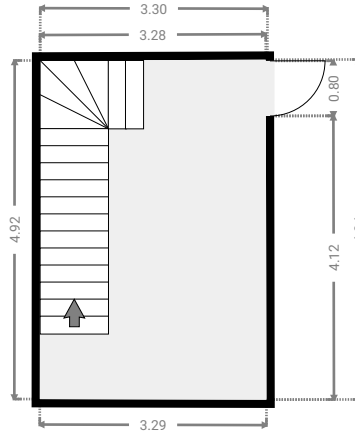

▼ Other Ground Floor

WIDTH: 12.84 m • LENGTH: 8.20 m
AREA: 105.25 m² • PERIMETER: 42.07 m

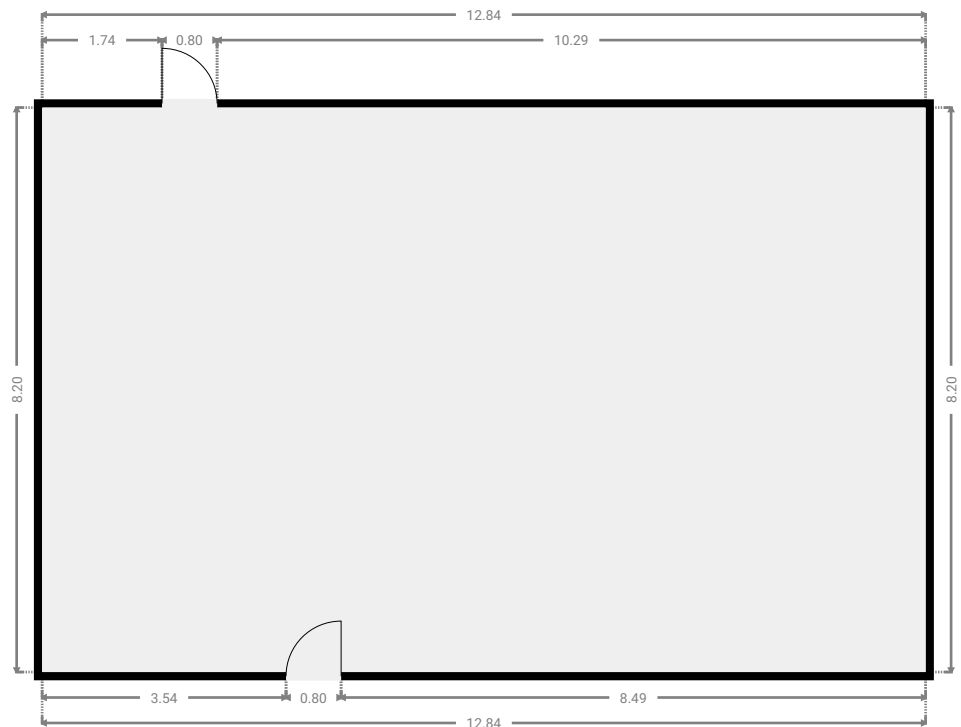
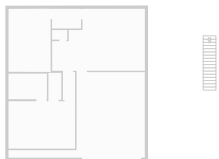

▼ 1st Floor

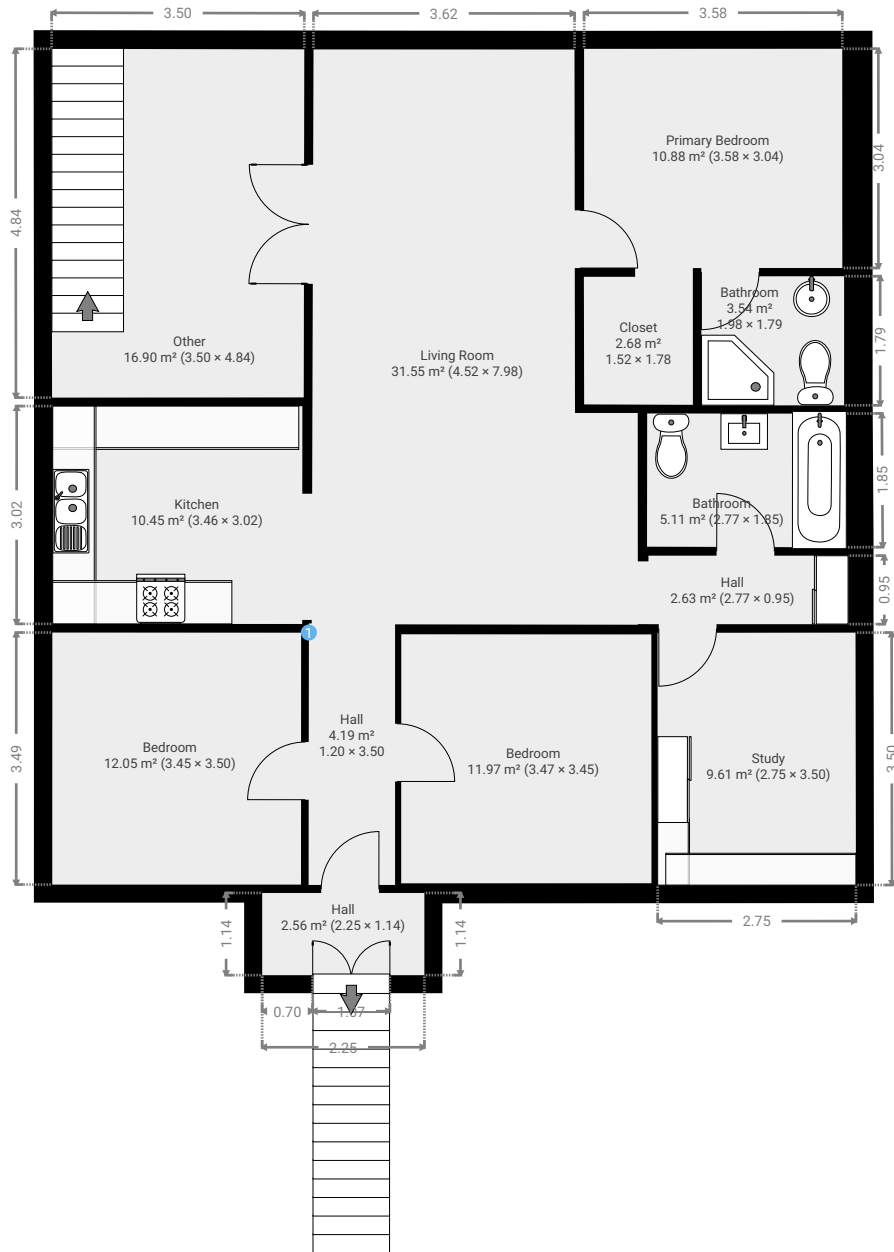

▼ **Bathroom**
1st Floor

WIDTH: 2.77 m • LENGTH: 1.85 m
AREA: 5.11 m² • PERIMETER: 9.22 m

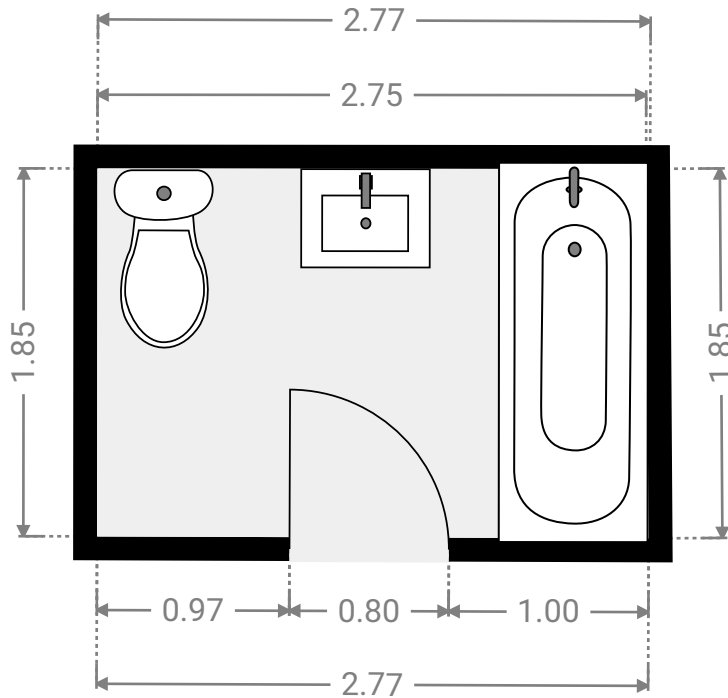
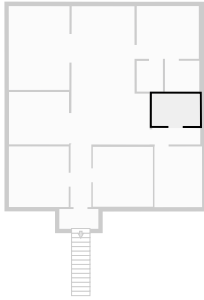

▼ **Bathroom**
1st Floor

WIDTH: 1.98 m • LENGTH: 1.79 m
AREA: 3.54 m² • PERIMETER: 7.54 m

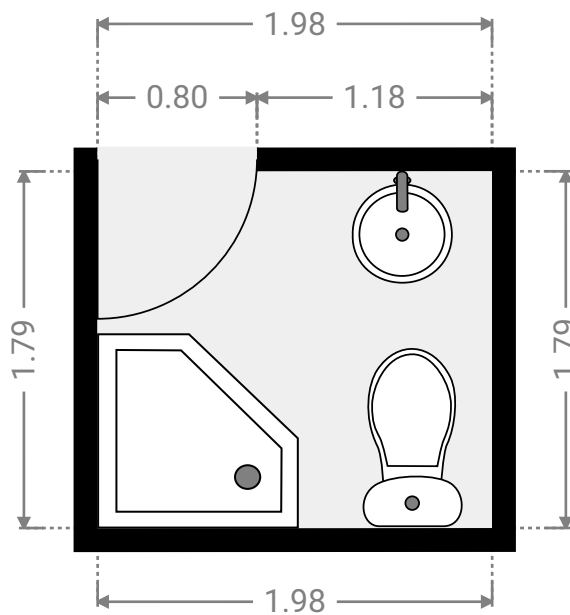
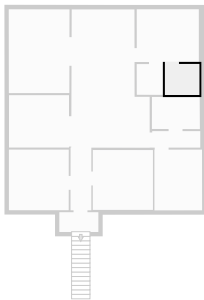

▼ **Bedroom**
1st Floor

WIDTH: 3.47 m • LENGTH: 3.45 m
AREA: 11.97 m² • PERIMETER: 13.84 m

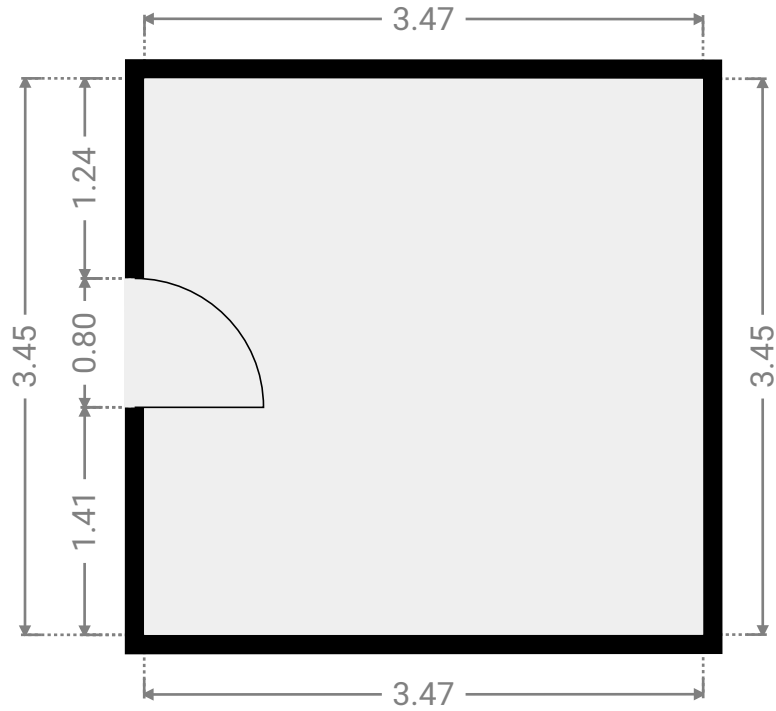
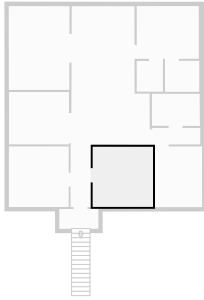

▼ **Bedroom**
1st Floor

WIDTH: 3.45 m • LENGTH: 3.50 m
AREA: 12.05 m² • PERIMETER: 13.89 m

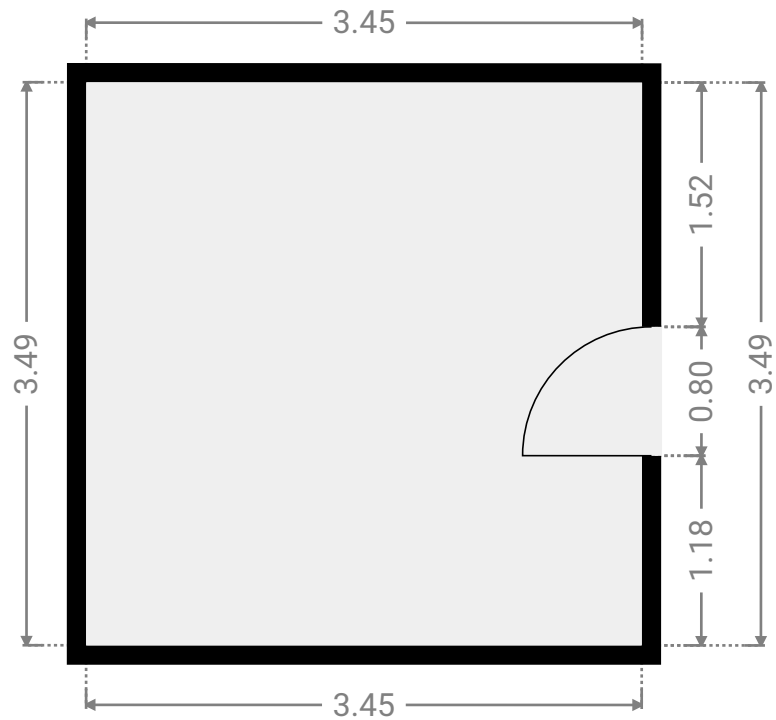
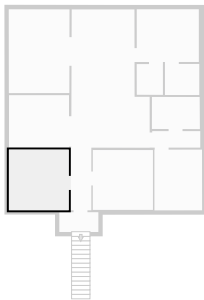

▼ **Hall**
1st Floor

WIDTH: 2.25 m • LENGTH: 1.14 m
AREA: 2.56 m² • PERIMETER: 6.78 m

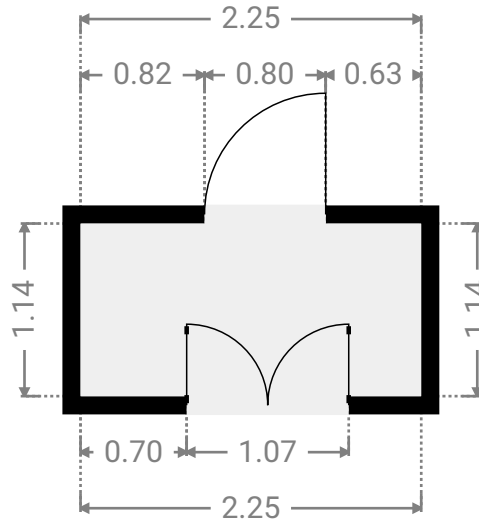
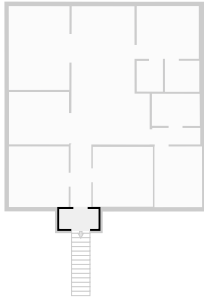

▼ **Hall**
1st Floor

WIDTH: 1.20 m • LENGTH: 3.50 m
AREA: 4.19 m² • PERIMETER: 9.40 m

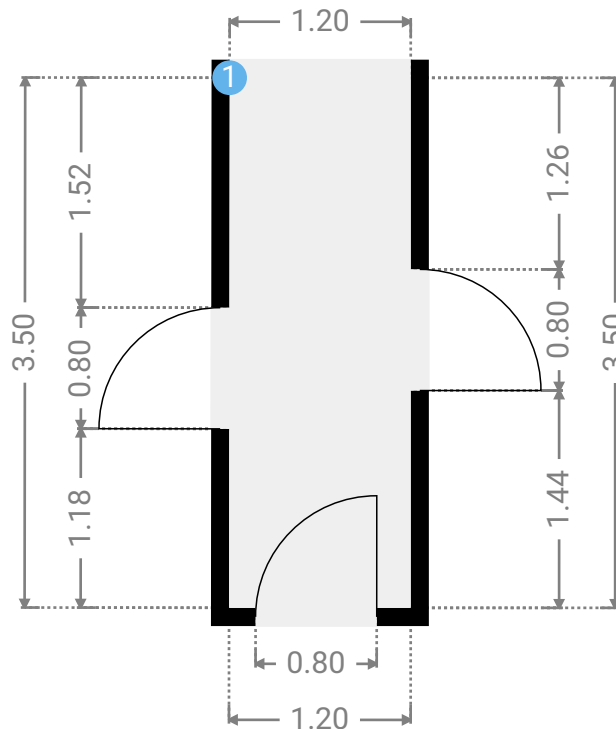
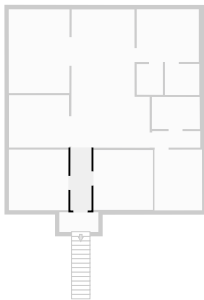

▼ Hall/1st Floor

1 OPENING

Height
0.00 m



▼ Hall 1st Floor

WIDTH: 2.77 m • LENGTH: 0.95 m
AREA: 2.63 m² • PERIMETER: 7.44 m

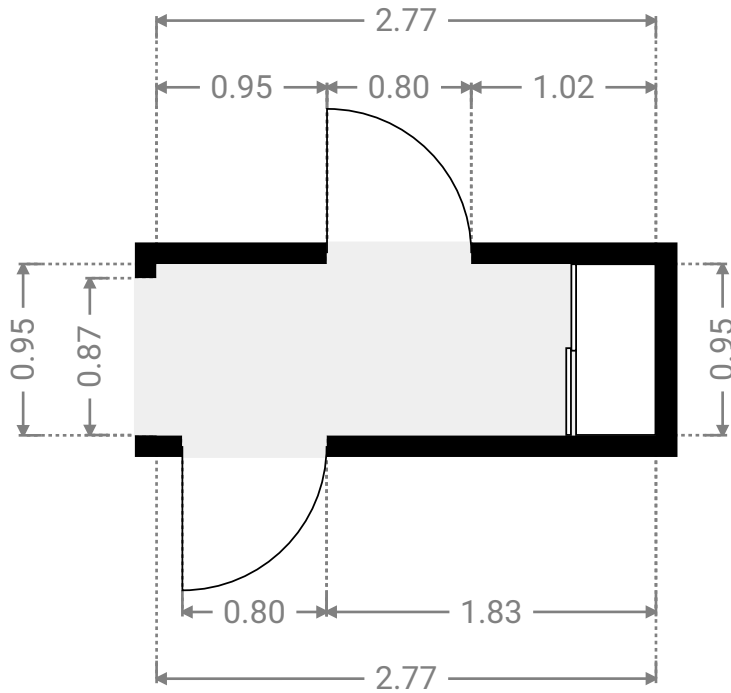
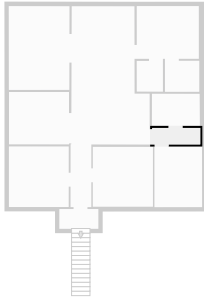

▼ Kitchen 1st Floor

WIDTH: 3.46 m • LENGTH: 3.02 m
AREA: 10.45 m² • PERIMETER: 12.96 m

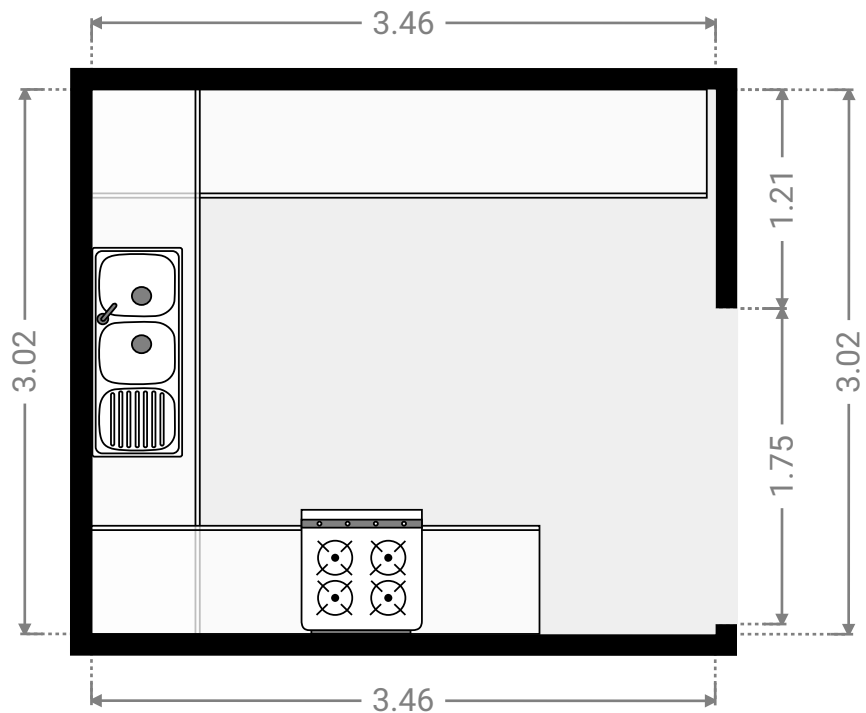
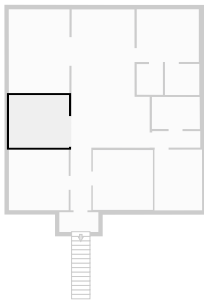

▼ Living Room 1st Floor

WIDTH: 4.52 m • LENGTH: 7.98 m
AREA: 31.55 m² • PERIMETER: 24.96 m

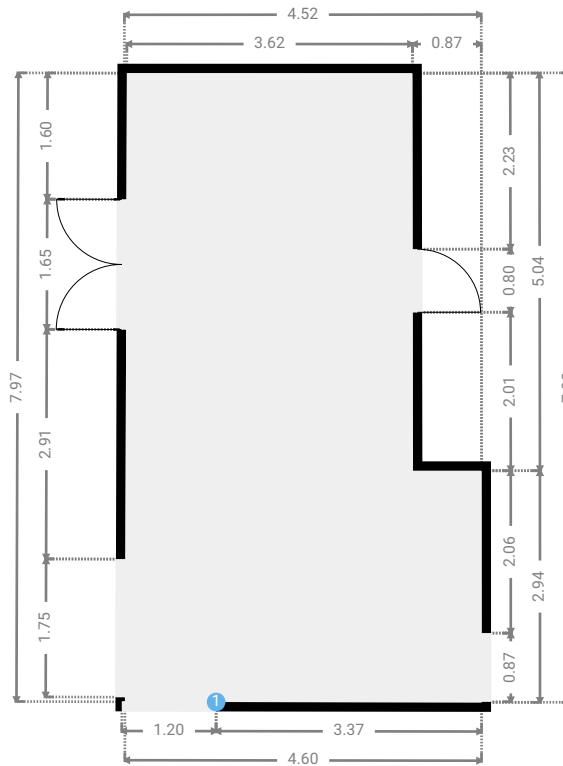
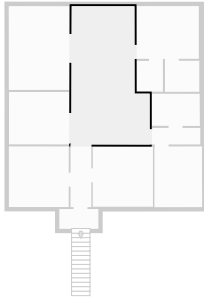

▼ Other 1st Floor

WIDTH: 3.50 m • LENGTH: 4.84 m
AREA: 16.90 m² • PERIMETER: 16.66 m

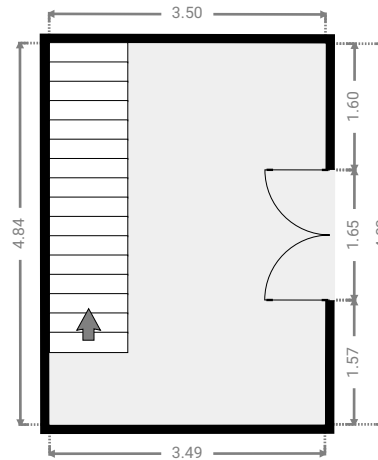
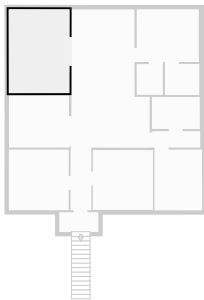

▼ **Primary Bedroom**
1st Floor

WIDTH: 3.58 m • LENGTH: 3.04 m
AREA: 10.88 m² • PERIMETER: 13.24 m

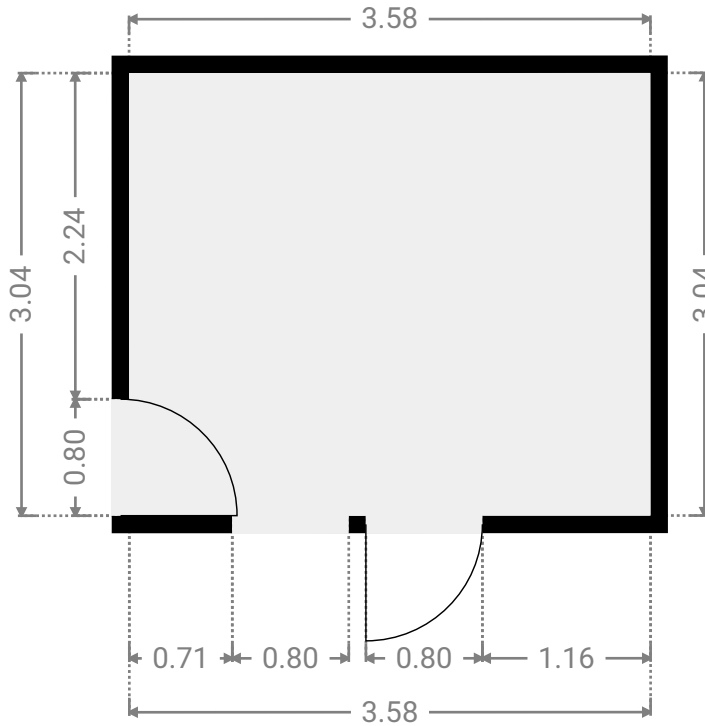
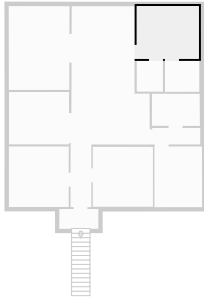

▼ **Closet**
1st Floor

WIDTH: 1.52 m • LENGTH: 1.78 m
AREA: 2.68 m² • PERIMETER: 6.57 m

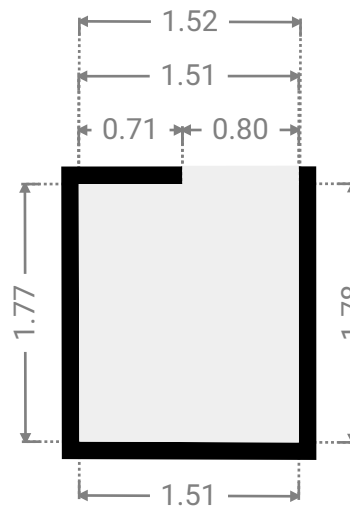
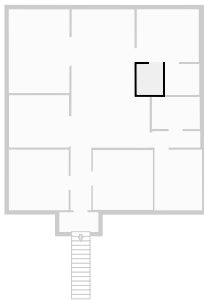

▼ Study
1st Floor

WIDTH: 2.75 m • LENGTH: 3.50 m
AREA: 9.61 m² • PERIMETER: 12.49 m

