

# 1/17 Stenlake Avenue

Created on  
2021-07-19

Floors  
1



▼ Ground Floor

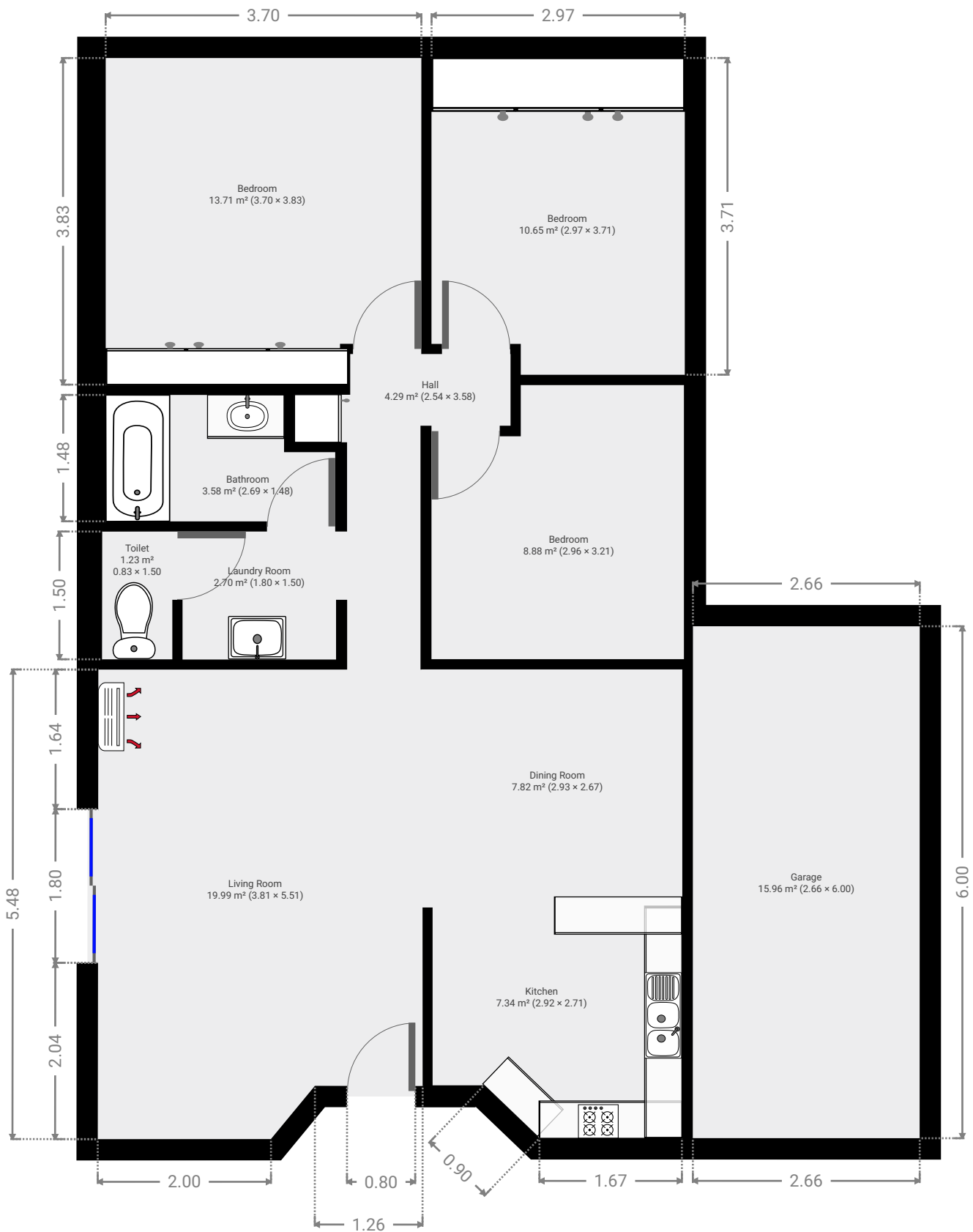

▼ Living Room  
Ground Floor

WIDTH: 3.81 m • LENGTH: 5.51 m  
AREA: 19.99 m<sup>2</sup> • PERIMETER: 18.29 m

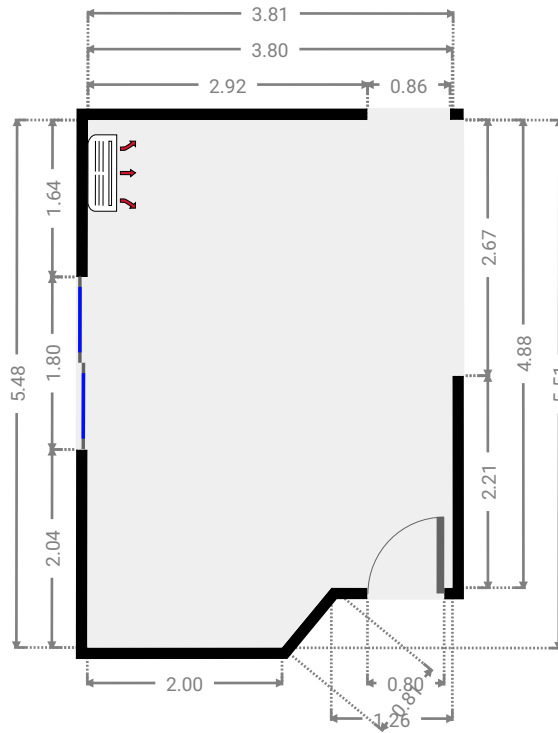
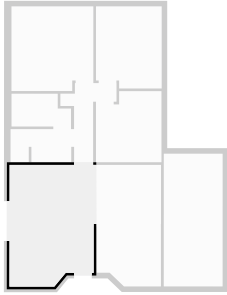

▼ Dining Room  
Ground Floor

WIDTH: 2.93 m • LENGTH: 2.67 m  
AREA: 7.82 m<sup>2</sup> • PERIMETER: 11.20 m

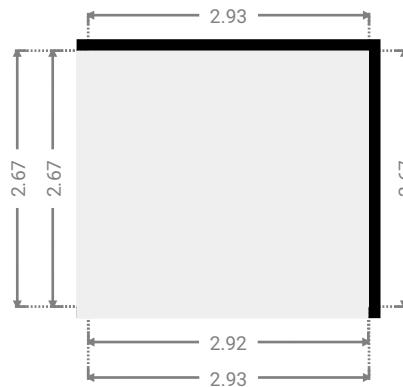
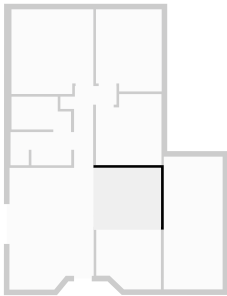

▼ **Kitchen**  
Ground Floor

WIDTH: 2.92 m • LENGTH: 2.71 m  
AREA: 7.34 m<sup>2</sup> • PERIMETER: 10.89 m

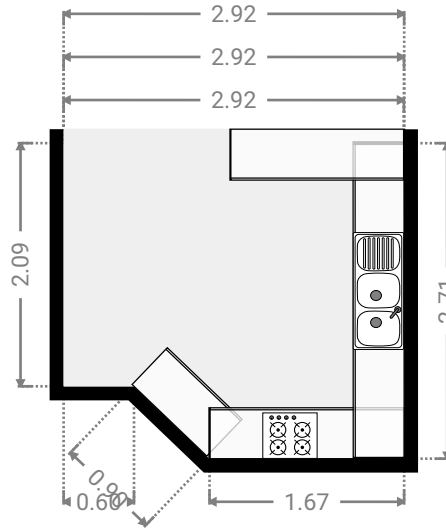
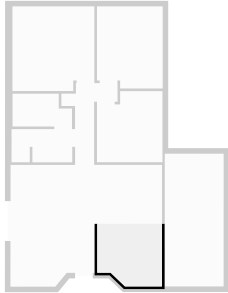

▼ **Hall**  
Ground Floor

WIDTH: 2.54 m • LENGTH: 3.58 m  
AREA: 4.29 m<sup>2</sup> • PERIMETER: 12.22 m

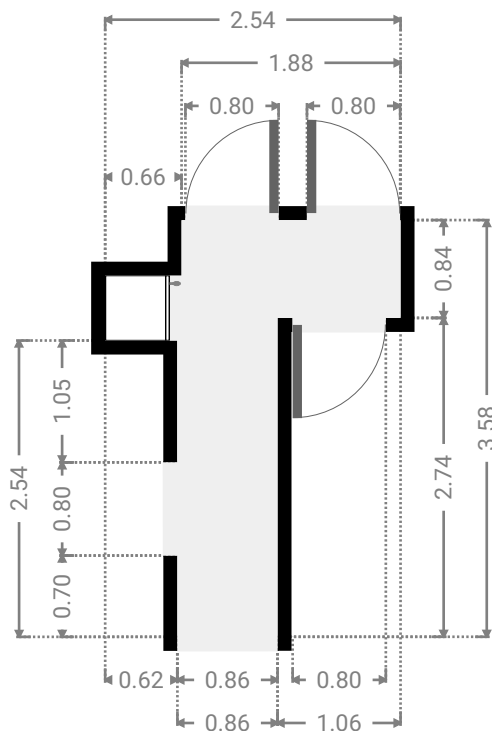
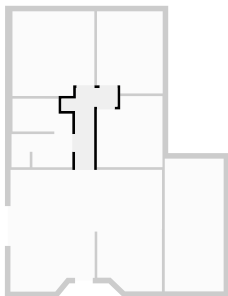

▼ **Laundry Room**  
Ground Floor

WIDTH: 1.80 m • LENGTH: 1.50 m  
AREA: 2.70 m<sup>2</sup> • PERIMETER: 6.60 m

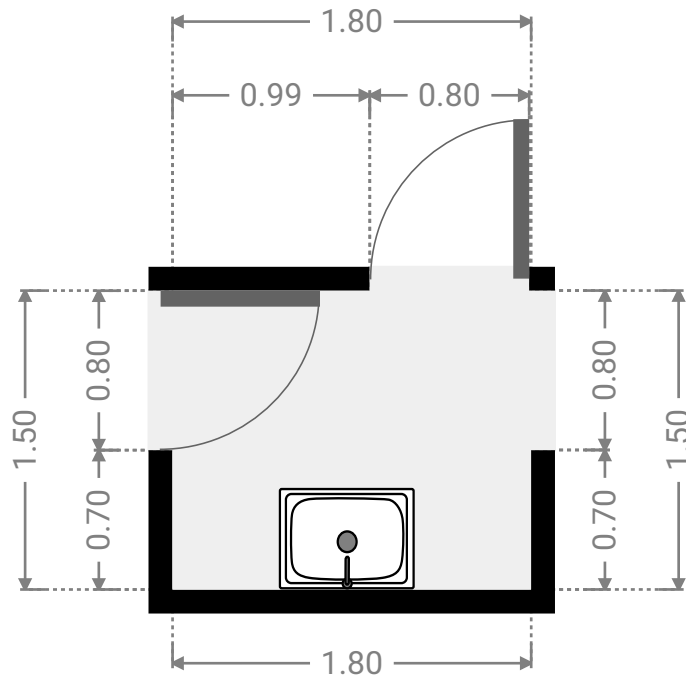
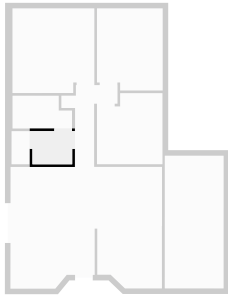

▼ **Toilet**  
Ground Floor

WIDTH: 0.83 m • LENGTH: 1.50 m  
AREA: 1.23 m<sup>2</sup> • PERIMETER: 4.64 m

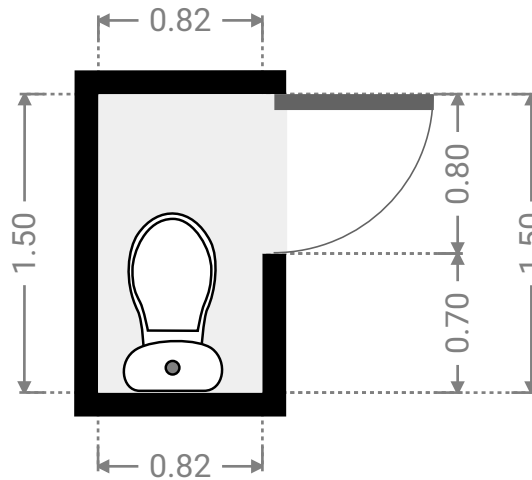
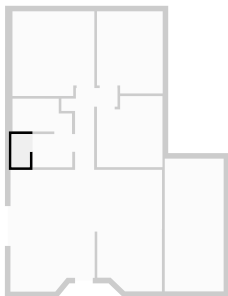

▼ **Bathroom**  
Ground Floor

WIDTH: 2.69 m • LENGTH: 1.48 m  
AREA: 3.58 m<sup>2</sup> • PERIMETER: 8.34 m

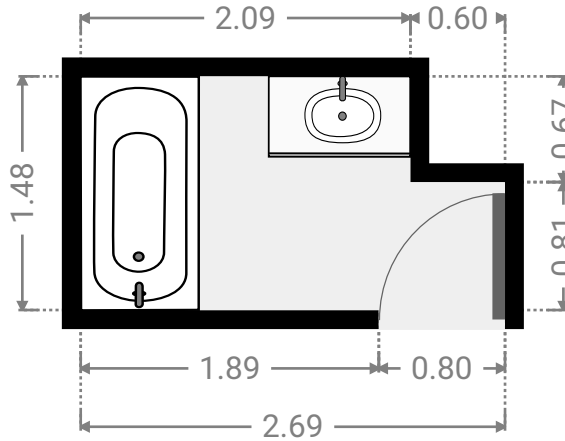
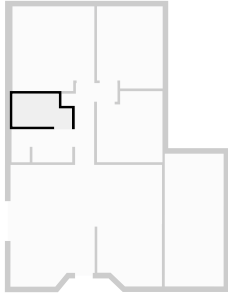

▼ **Bedroom**  
Ground Floor

WIDTH: 2.96 m • LENGTH: 3.21 m  
AREA: 8.88 m<sup>2</sup> • PERIMETER: 12.34 m

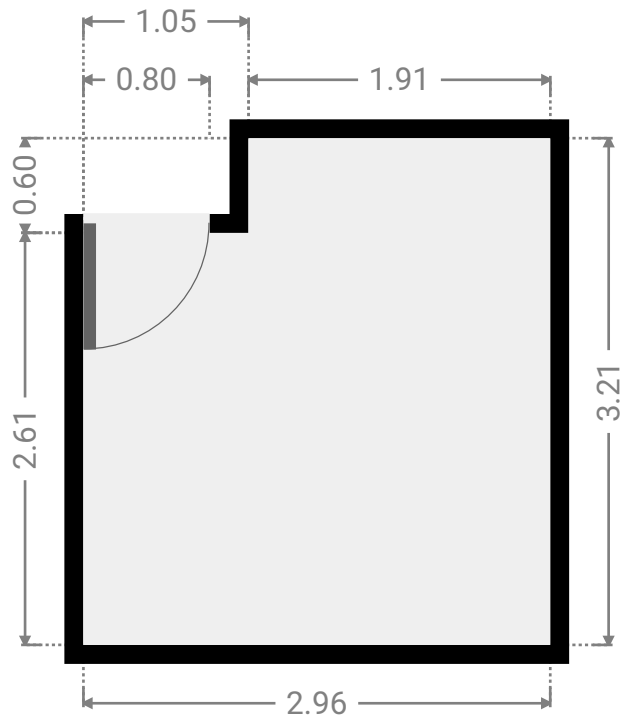
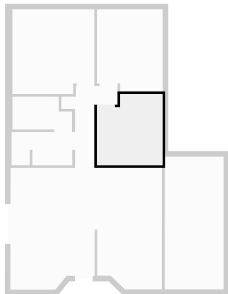

▼ **Bedroom**  
Ground Floor

WIDTH: 2.97 m • LENGTH: 3.71 m  
AREA: 10.65 m<sup>2</sup> • PERIMETER: 13.36 m

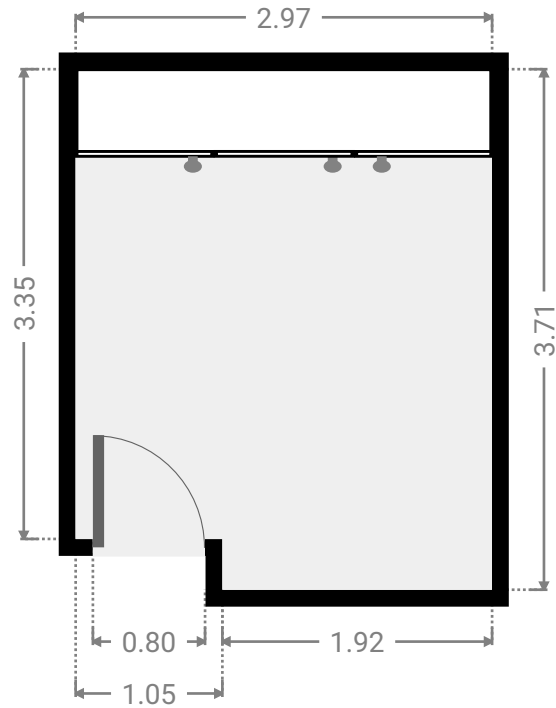
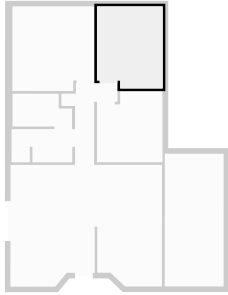

▼ **Bedroom**  
Ground Floor

WIDTH: 3.70 m • LENGTH: 3.83 m  
AREA: 13.71 m<sup>2</sup> • PERIMETER: 15.06 m

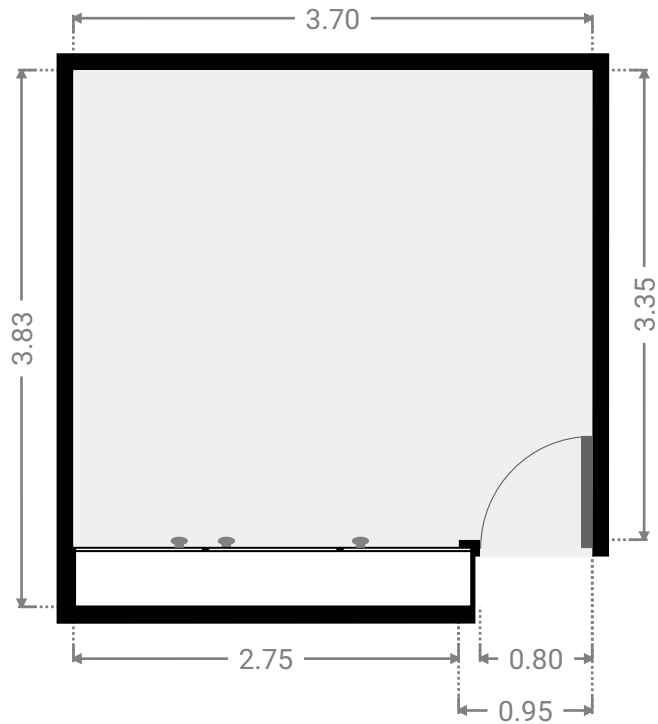
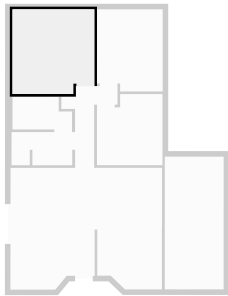

▼ **Garage**  
Ground Floor

WIDTH: 2.66 m • LENGTH: 6.00 m  
AREA: 15.96 m<sup>2</sup> • PERIMETER: 17.32 m

